



# FIM-7901E Processing Module Guide

FortiGate-7000E Series

**FORTINET DOCUMENT LIBRARY**

<https://docs.fortinet.com>

**FORTINET VIDEO GUIDE**

<https://video.fortinet.com>

**FORTINET BLOG**

<https://blog.fortinet.com>

**CUSTOMER SERVICE & SUPPORT**

<https://support.fortinet.com>

**FORTINET TRAINING & CERTIFICATION PROGRAM**

<https://www.fortinet.com/support-and-training/training.html>

**NSE INSTITUTE**

<https://training.fortinet.com>

**FORTIGUARD CENTER**

<https://fortiguard.com/>

**END USER LICENSE AGREEMENT**

<https://www.fortinet.com/doc/legal/EULA.pdf>

**FEEDBACK**

Email: [techdoc@fortinet.com](mailto:techdoc@fortinet.com)



October 25, 2019

FIM-7901E 5.6.11 Build 4279 Processing Module Guide

01-606-389680-20191025

# TABLE OF CONTENTS

<b>Change log</b> .....	<b>4</b>
<b>FIM-7901E interface module</b> .....	<b>5</b>
Mounting hardware .....	5
Module levers .....	5
Power sliders .....	6
Secure screws .....	6
Front panel interfaces .....	6
Physical description .....	7
Front panel LEDs .....	7
Supported transceivers .....	8
Turning the module on and off .....	9
NMI switch .....	9
FIM-7901E hardware architecture .....	9
<b>Hardware installation</b> .....	<b>11</b>
Installing SFP+ and SFP transceivers .....	11
To install transceivers .....	11
FIM-7901E mounting hardware .....	12
Inserting a FIM-7901E module into a chassis .....	13
Shutting down and removing a FIM-7901E module from a chassis .....	17
Troubleshooting .....	22
FIM-7901E does not startup .....	22
FIM-7901E status LED is flashing during system operation .....	22
<b>Quick FIM-7901E configuration</b> .....	<b>23</b>
Registering your FortiGate-7000 series products .....	23
Choosing the configuration tool .....	23
Changing network settings .....	23
<b>Cautions and warnings</b> .....	<b>25</b>
Environmental specifications .....	25
Safety .....	26
<b>Regulatory notices</b> .....	<b>27</b>
Federal Communication Commission (FCC) – USA .....	27
Industry Canada Equipment Standard for Digital Equipment (ICES) – Canada .....	27
European Conformity (CE) - EU .....	27
Voluntary Control Council for Interference (VCCI) – Japan .....	28
Bureau of Standards Metrology and Inspection (BSMI) – Taiwan .....	28
China .....	28

# Change log

Date	Change description
October 25, 2019	Restructuring and bug fixing.



# FIM-7901E interface module

The FIM-7901E interface module is a hot swappable module that provides data, management, and session sync/heartbeat interfaces, base backplane switching, and fabric backplane session-aware load balancing for a FortiGate-7000 series chassis. The FIM-7901E includes an integrated switch fabric and DP2 processors to load balance millions of data sessions over the chassis fabric backplane to FPM processor modules. The FIM-7901E also includes a 1Gbps base backplane channel for base backplane management communication with each FPM module in the chassis, one 40Gbps fabric backplane channel for fabric backplane communication with the FIM module(s) in the chassis, and a second 1Gbps base backplane channel for base backplane communication with the FIM module(s) in the chassis.

The FIM-7901E can be installed in any FortiGate-7000 series chassis in chassis hub/switch slots 1 or 2. The FIM-7901E provides thirty-two 10GigE small form-factor pluggable plus (SPF+) interfaces for a FortiGate-7000 chassis.

You can also install FIM-7901Es in a second chassis and operate the chassis in HA mode to provide chassis failover protection.

## FIM-7901E front panel

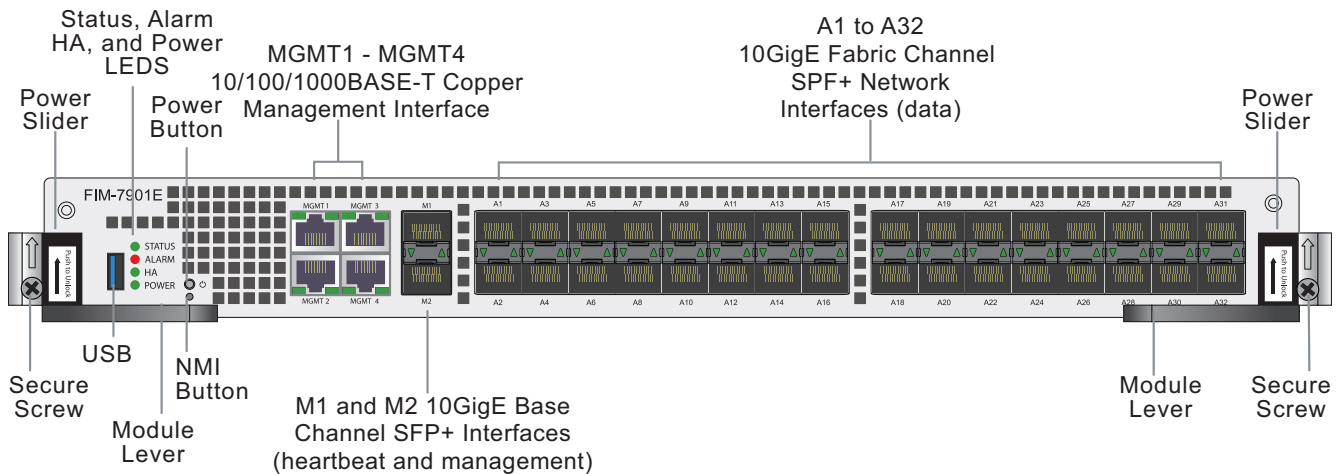

## Mounting hardware

Use the module levers, power sliders, and secure screws to insert, secure and remove the module from the chassis.

## Module levers

Carefully slide the module all of the way into the chassis slot and fully close the module levers to seat the module into the chassis slot and to connect the module to the chassis backplane connectors. When both module levers are fully closed, the power sliders can be lowered to their bottom position, locking the module levers and turning on power to the module.

Raise the power sliders to unlock the module levers and turn off module power. Then open the module levers to eject the module from the backplane connectors; allowing the module to be removed from the chassis.

The module lever mechanism helps reduce the engagement force required to insert or eject the module from the backplane connectors.

The module levers do not fully secure the module in the chassis. The secure screws must be tightened to reliably secure the module in the chassis and to make sure the module remains securely connected to the backplane for power and network connectivity.

## Power sliders

Close the module levers and move the power sliders to their bottom position to lock the module levers and turn the module power switch on.

Move the power sliders to the top position to unlock the module levers and turn the module power switch off.

Gently push the power sliders down to make sure they are in their bottom position. If the module LEDs do not light the module is not receiving power. If this happens check the power sliders to make sure they are in their bottom position.

## Secure screws

Fully tighten the secure screws to lock the module in the chassis providing a secure and reliable connection with the backplane.

Loosen the secure screws before ejecting the module from the chassis.

## Front panel interfaces

You connect the FIM-7901E to your 10Gbps networks using the A1 to A32 front panel SFP+ interfaces. The front panel also includes M1 and M2 SFP+ interfaces for the base channel, four Ethernet management interfaces (MGMT1 to MGMT4), and a USB port. The USB port can be used with any USB key for backing up and restoring configuration files.

Connector	Type	Speed	Protocol	Description
A1 to A32	SFP+	10Gbps/1Gbps	Ethernet	Thirty-two front panel 10GigE SFP+ fabric channel interfaces. These interfaces are connected to 10Gbps networks to distribute sessions to the FPM processor modules installed in chassis slots 3 and up. These interfaces can also be configured to operate as Gigabit Ethernet interfaces using SFP transceivers. These interfaces also support creating link aggregation groups (LAGs) that can include interfaces from both FIM-7901Es.
M1 and M2	SFP+	10Gbps/1Gbps	Ethernet	Two front panel 10GigE SFP+ interfaces that

Connector	Type	Speed	Protocol	Description
				connect to the base backplane channel. These interfaces are used for heartbeat, session sync, and management communication between FIM-7901Es in different chassis. These interfaces can also be configured to operate as Gigabit Ethernet interfaces using SFP transceivers, but should not normally be changed. If you use switches to connect these interfaces, the switch ports should be able to accept packets with a maximum frame size of at least 1526. The M1 and M2 interfaces need to be on different broadcast domains. If M1 and M2 are connected to the same switch, Q-in-Q must be enabled on the switch
MGMT1 to MGMT4	RJ-45	10/100/1000Mbps	Ethernet	Four 10/100/1000BASE-T copper out of band management Ethernet interfaces.
USB	USB 3.0 Type A		USB 3.0 USB 2.0	Standard USB connector.

## Physical description

<b>Dimensions</b>	1.88 x 17.11 x 18.49 in. (48 x 435 x 470 mm) (Height x Width x Length)
<b>Weight</b>	16 lb. (7.3 kg)
<b>Operating Temperature</b>	32 to 104°F (0 to 40°C)
<b>Storage Temperature</b>	-31 to 158°F (-35 to 70°C)
<b>Relative Humidity</b>	10% to 90% (Non-condensing)
<b>Power consumption</b>	Max: 450W; Average: 400W
<b>Max Current</b>	37.5A
<b>Heat Dissipation</b>	1531BTU/h
<b>Joules/h</b>	1609KJ/h

## Front panel LEDs

From the FIM-7901E front panel you can view the status of the module LEDs to verify that the module is functioning normally.

LED	State	Description
STATUS	Off	The FIM-7901E is powered off.
	Green	The FIM-7901E is powered on and operating normally.
	Flashing Green	The FIM-7901E is starting up.
ALARM	Red	Major alarm.
	Amber	Minor alarm
	Off	No alarms
HA	Off	The FIM-7901E is operating in normal mode.
	Green	The FIM-7901E is operating in HA mode.
	Red	A failover has occurred
POWER	Green	The FIM-7901E is powered on and operating normally.
	Off	The FIM-7901E is powered off.
A1 to A32 M1 and M2	Green	The correct cable is connected to the interface and the connected equipment has power.
	Flashing Green	Network activity at the interface.
	Off	No link is established.
MGMT1-4 Link/Act	Solid Green	Indicates this interface is connected with the correct cable and the attached network device has power.
	Blinking Green	Indicates network traffic on this interface.
	Off	No Link
MGMT1-4 Speed	Green	Connection at 1Gbps.
	Amber	Connection at 100Mbps.
	Off	Connection at 10Mbps.

## Supported transceivers

Transceivers available from Fortinet for the FIM-7901E A1 to A32 SFP+ interfaces.

Transceiver	Description
FG-TRAN-SFP+SR	10GE SFP+ transceiver module, short range.
FG-TRAN-SFP+LR	10GE SFP+ transceiver module, long range.
FG-TRAN-SFP-LX	1 GE SFP LX transceiver module.
FG-TRAN-SFP-SX	1 GE SFP SX transceiver module.

## Turning the module on and off

You can use the front panel power button to turn the FIM-7901E power on or off. If the FIM-7901E is powered on, press the power switch to turn it off. If the FIM-7901E is turned off and installed in a chassis slot, press the power button to turn it on.

## NMI switch

When working with Fortinet Support to troubleshoot problems with the FIM-7901E you can use the front panel non-maskable interrupt (NMI) switch to assist with troubleshooting. Pressing this switch causes the software to dump registers/backtraces to the console. After the data is dumped the FIM-7901E reboots. While the FIM-7901E is rebooting, traffic is temporarily blocked. The FIM-7901E should restart normally and traffic can resume once the it is up and running.

## FIM-7901E hardware architecture

The FIM-7901E includes an integrated switch fabric (ISF) that connects the front panel interfaces to the DP2 session-aware load balancers and to the chassis backplanes. The ISF also allows the DP2 processors to distribute sessions among all NP6 processors on the FPM modules in the same chassis.

The FIM-7901E also includes the following backplane communication channels:

- One 80Gbps fabric backplane channel to distribute traffic to the FPMs.
- One 1Gbps base backplane channel for base backplane communication with the FPMs.
- One 40Gbps fabric backplane channel for fabric backplane communication with the other FIM.
- One 1Gbps base backplane channel for base backplane communication with the other FIM.

**FIM-7901E hardware architecture**

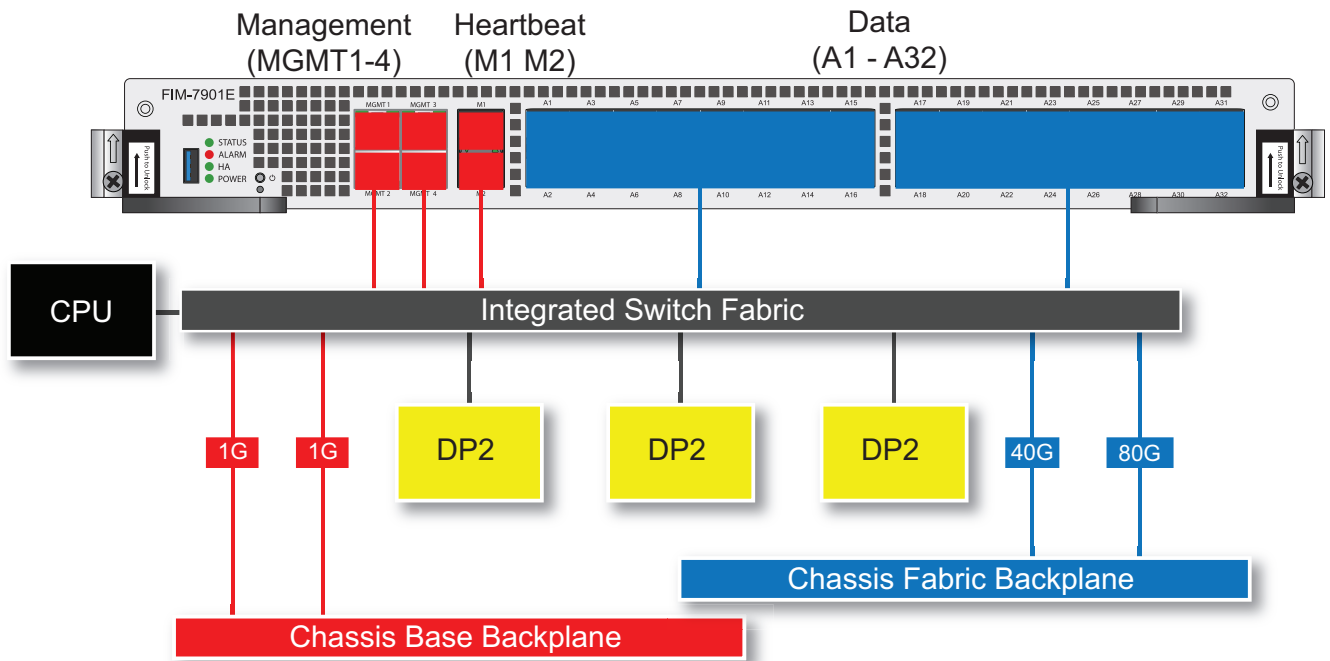

# Hardware installation

This chapter describes installing a FIM-7901E interface module into a FortiGate-7000 chassis.

## Installing SFP+ and SFP transceivers

You must install SFP+ transceivers into the FIM-7901E front panel A1 to A32 interfaces before connecting them to 10Gbps networks. The FIM-7901E ships with two 10GBASE-SR SFP+ transceivers. You can also configure the A1 to A32 interfaces to operate at 1Gbps and install SFP transceivers. You can install the transceivers before or after inserting the FIM-7901E module into a chassis.

You must install SFP+ transceivers into the FIM-7901E M1 and M2 interfaces before connecting them to 10Gbps networks. You can also configure the M1 and M2 interfaces to operate at 1Gbps and install SFP transceivers. You can install these transceivers before or after inserting the FIM-7901E board into a chassis.

You can install the following types of transceivers for connectors M1 and M2:

- 10GBASE-SR SFP+ (10Gbps)
- 10GBASE-LR SFP+ (10Gbps)
- 1000BASE SFP (1Gbps)



The M1 and M2 interfaces are used for heartbeat, session sync, and management communication between FIM-7901Es in different chassis. This communication requires 10 Gbps connections so, even though it supported, the M1 and M2 interfaces should not be changed to 1000Base SFP 1Gbps interfaces.

---

## To install transceivers

To complete this procedure, you need:

- A FIM-7901E
- Transceivers to install
- An electrostatic discharge (ESD) preventive wrist strap with connection cord



FIM-7901Es must be protected from static discharge and physical shock. Only handle or work with FIM-7901Es at a static-free workstation. Always wear a grounded electrostatic discharge (ESD) preventive wrist strap when handling FIM-7901Es.

Handling the transceivers by holding the release latch can damage the connector. Do not force transceivers into their cage slots. If the transceiver does not easily slide in and click into place, it may not be aligned correctly. If this happens, remove the transceiver, realign it and slide it in again.

---

1. Attach the ESD wrist strap to your wrist and to an available ESD socket or wrist strap terminal.
2. Remove the caps from the cage sockets on the FIM-7901E front panel.
3. Hold the sides of the transceiver and slide it into the cage socket until it clicks into place.

## FIM-7901E mounting hardware

To install an FIM-7901E you slide the module into a hub/switch slot in the front of an FortiGate-7000 series chassis (either slot 1 or 2) and then use the mounting hardware, described in [Mounting hardware on page 5](#), to lock the module into place in the slot. When locked into place and positioned correctly, the module front panel is flush with the chassis front panel and connected to the chassis backplane.

To position the module correctly, you must use the mounting hardware shown below for the right of the FIM-7901E front panel. The mounting hardware on the left of the front panel is the same but reversed. The FIM-7901E mounting hardware aligns the module in the chassis slot and is used to insert and eject the module from the slot.



On some FIM modules there may be very little clearance between the front panel interfaces and the module lever on the right side of the FIM-7901E. In fact, you may have to remove network connectors from some front panel interfaces to open the module lever. In most cases you should remove all network connectors from the front panel before opening the module levers to remove an FIM module from a chassis slot.

### FIM-7901E mounting hardware

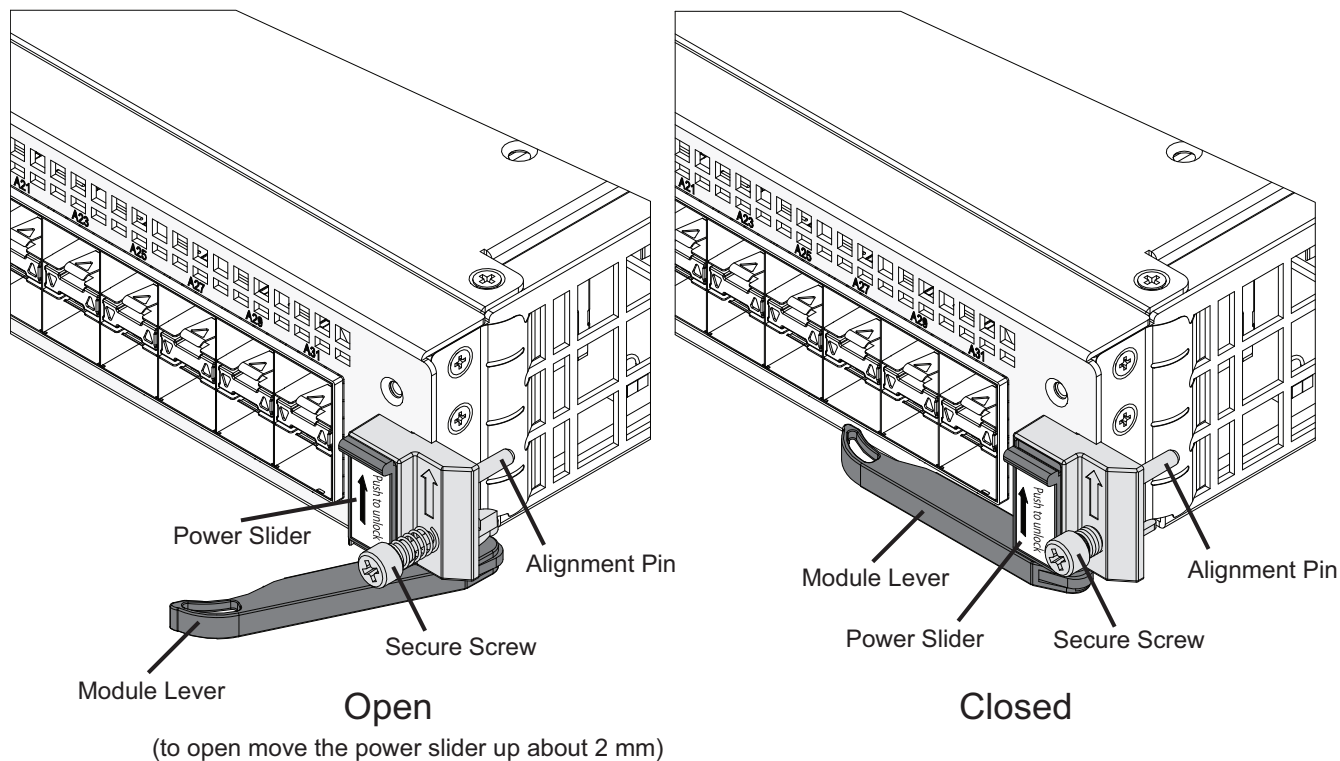



The FIM-7901E module levers align the module in the chassis slot and insert and eject the module from the slot. The power sliders activate micro switches that turn on or turn off power to the module. When both sliders are raised, the module cannot receive power. When the sliders are fully closed, the module can receive power if it is fully inserted into a chassis slot.

## Inserting a FIM-7901E module into a chassis

This procedure describes how to insert a FIM-7901E module into slot 1 or 2 of a FortiGate-7000 chassis. The procedure includes photographs to illustrate the procedure steps. The photos were taken in one of Fortinet's hardware labs using a generic module and FortiGate-7000 chassis.



You must carefully slide the module all the way into the chassis slot, close the module levers to seat the module into the slot, and tighten the secure screws to make sure the module is fully engaged with the backplane and secured. You must also make sure that the power sliders are fully closed by gently pushing them down.

### Installation Highlights:

1. Module levers must be closed.
2. Secure screws must be tightened.
3. Power sliders must be fully closed for the module to get power and start up.

If the module is not receiving power all LEDs remain off.

FIM-7901E modules are hot swappable. This procedure is the same whether or not the chassis is powered on.



Do not carry the FIM-7901E module by holding the module levers or secure screws. When inserting or removing the FIM-7901E from a chassis slot, handle the module by the front panel. The levers are not designed for carrying the module. If the levers become bent or damaged, the FIM-7901E may not align correctly in the chassis slot.

To complete this procedure, you need the following equipment and tools:

- a FIM-7901E
- a FortiGate-7000 chassis with an empty slot
- an electrostatic discharge (ESD) preventive wrist strap with connection cord
- a Phillips screwdriver



FIM-7901Es must be protected from static discharge and physical shock. Only handle or work with FIM-7901Es at a static-free workstation. Always wear a grounded electrostatic discharge (ESD) preventive wrist strap when handling FIM-7901Es. Attach the ESD wrist strap to your wrist and to an ESD socket or to a bare metal surface on the chassis or frame. (An ESD wrist strap is not visible in the photographs below because they were taken in an ESD safe lab environment.)

### 1. Remove the FIM-7901E module from its packaging.

The module levers are closed when you first remove a new module from its packaging.

### 2. Align the module with the chassis slot, slowly slide the module into the slot, stop at about 1-2 inches from fully inserting it.

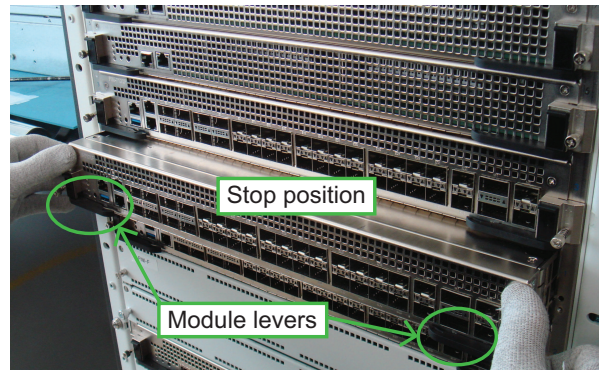
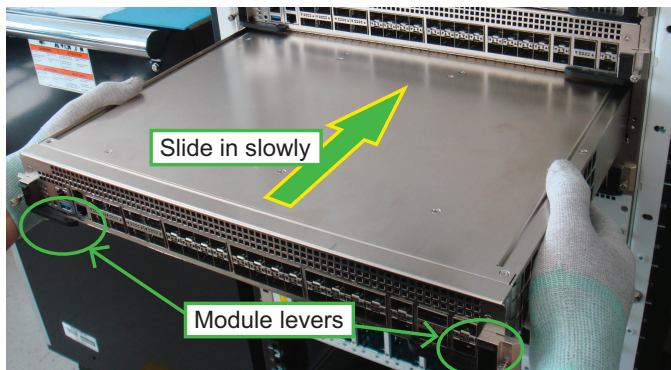

### 3. Unlock the left and right module levers by pushing the power sliders up until the levers pop open.

Before sliding the final portion of the module into the chassis fully open both levers by pushing the power sliders up. Fully open both levers to avoid damaging the lever mechanism. Damaging the levers can prevent the module from connecting to power.

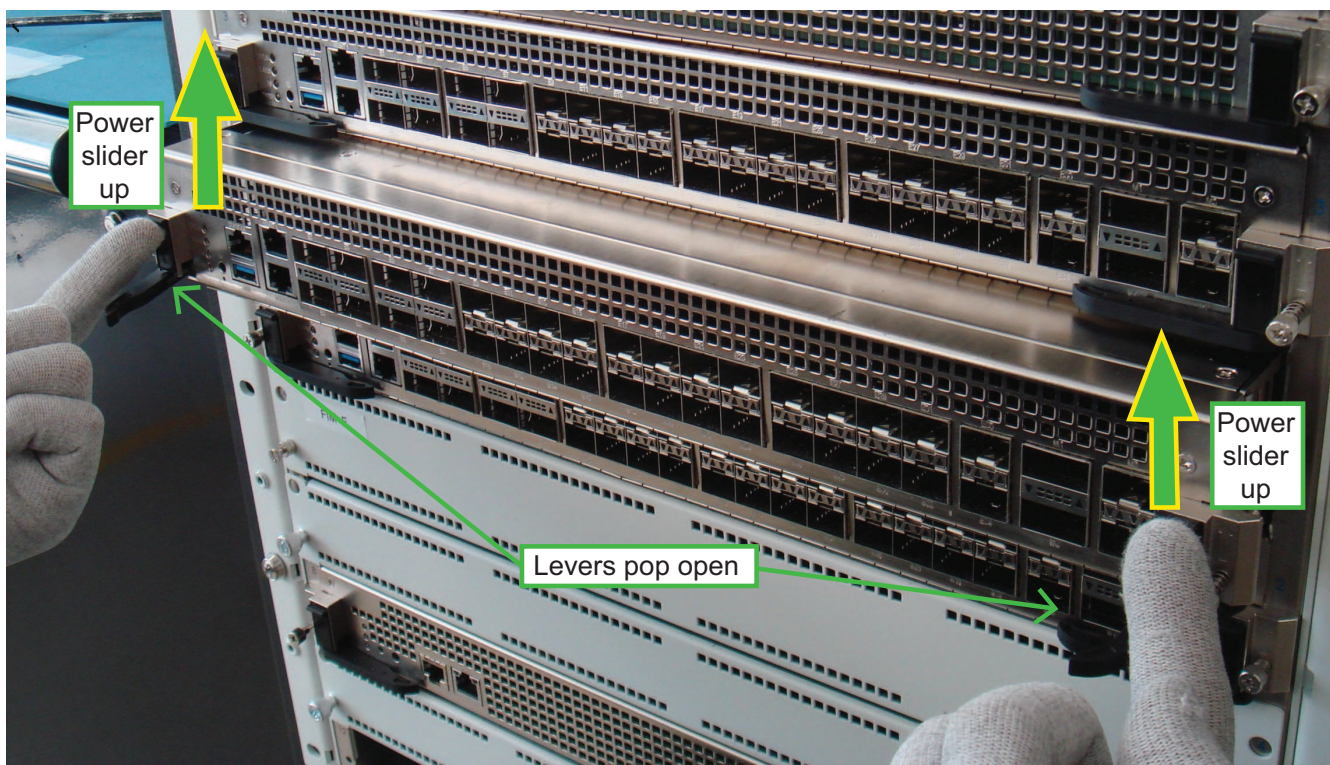



#### 4. Continue pushing the module into the slot until the levers engage with the sides of the chassis slot.

Insert the module by applying moderate force to the front faceplate (not the levers) to slide the module into the slot. The module should glide smoothly. If you encounter any resistance, the module could be aligned incorrectly. Pull the module back out and try inserting it again.

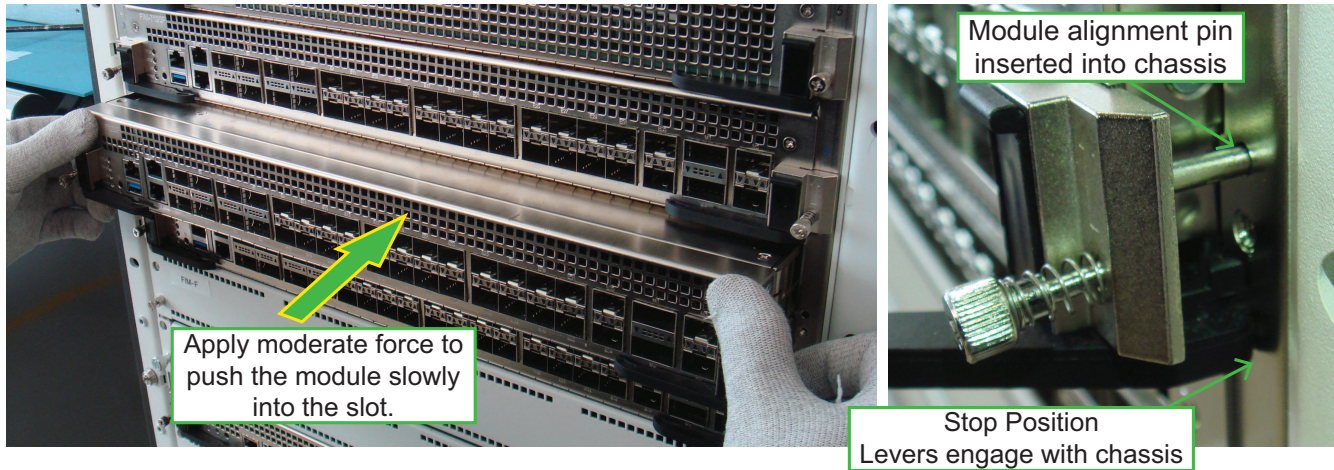

#### 5. Close both levers by pushing them into contact with the module front panel.

Closing the levers draws the module into the chassis slot and connects the module rear connectors to the chassis backplane. The design of the levers leaves gaps to compensate for tolerances. So even when the levers are fully closed, the module may not be fully into position and in contact with the chassis backplane.

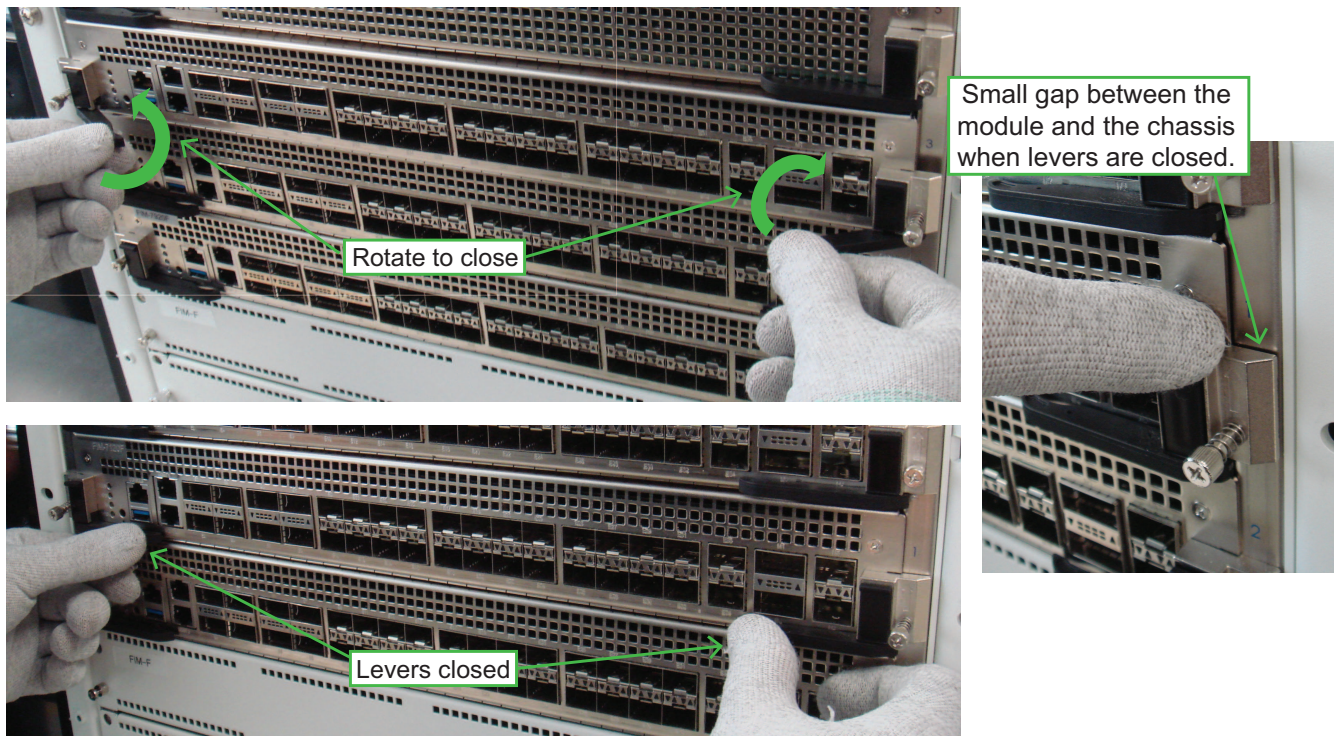



## 6. Tighten both secure screws to close the gap between the module and the chassis.

Begin by engaging the secure screws into the chassis tapped hole by hand and roughly tighten them. Then use a Phillips screwdriver to fully tighten the two secure screws. Do not use a power screwdriver, because the high torque and speed can damage the chassis or screw thread. After tightening both secure screws, the module is fully seated in the chassis slot and the module connectors are fully in contact with the chassis backplane.

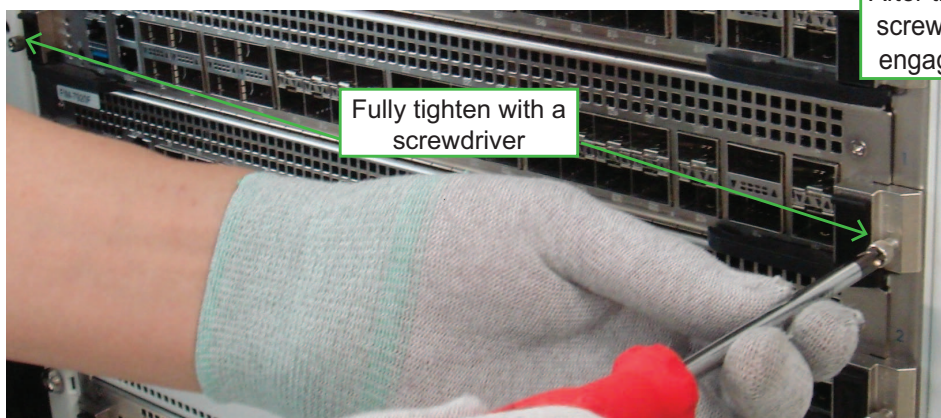

After tightening both secure screws, the module is fully engaged with the chassis.



## 7. Push down both power sliders to make sure the module power switch is on.

When the module is fully in position, the power sliders should drop down, lock the levers, and turn module power on. Gently push both power sliders down to their bottom position to make sure they are fully closed.

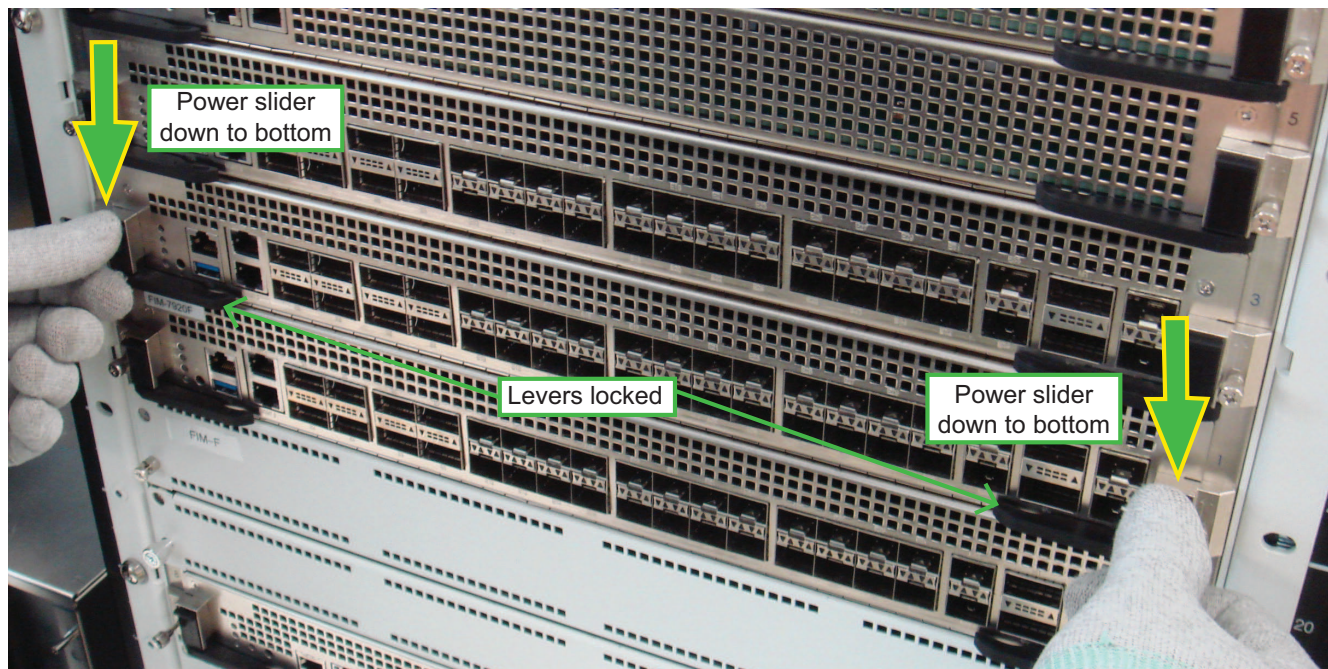

## 8. If the chassis is powered on, check the module LEDs to verify that the module is operating correctly

LED	Normal operation state
Status	Green
Alarm	Off
HA	Off
Power	Green

## Shutting down and removing a FIM-7901E module from a chassis

This procedure describes how to shut down and remove a FIM-7901E module from FortiGate-7000 chassis. The procedure includes photographs to illustrate the procedure steps. The photos were taken in one of Fortinet's hardware labs using a generic module and FortiGate-7000 chassis.

FIM-7901Es are hot swappable. This procedure is the same whether or not the chassis is powered on.



Do not carry the FIM-7901E by holding the module levers or secure screws. When inserting or removing the FIM-7901E from a chassis slot, handle the module by the front panel. The levers are not designed for carrying the module. If the levers become bent or damaged, the FIM-7901E may not align correctly in the chassis slot.

---

To complete this procedure, you need the following equipment and tools:

- a FortiGate-7000 chassis with a FIM-7901E module installed
  - an electrostatic discharge (ESD) preventive wrist strap with connection cord
  - a Phillips screwdriver
- 



FIM-7901Es must be protected from static discharge and physical shock. Only handle or work with FIM-7901Es at a static-free workstation. Always wear a grounded electrostatic discharge (ESD) preventive wrist strap when handling FIM-7901Es. (An ESD wrist strap is not visible in the photographs below because they were taken in an ESD safe lab environment.)

---

## 1. Shut down the module operating system properly.

To avoid potential hardware problems, always shut down the module operating system properly before removing the module from a chassis slot or before powering down the chassis. To shutdown the module, connect to the module GUI and select **Shutdown** from the administrator menu. Or, from the module CLI, enter the `execute shutdown` command.

## 2. Disconnect all cables from the module, including all network cables and USB cables or keys.



### 3. Use a Phillips screwdriver to loosen both secure screws and then fully loosen them by hand.

Fully loosen the secure screws, otherwise the levers may be damaged when used to eject the module from the chassis slot. Do not use a power screwdriver, because the high torque and speed can damage the chassis or screw thread.

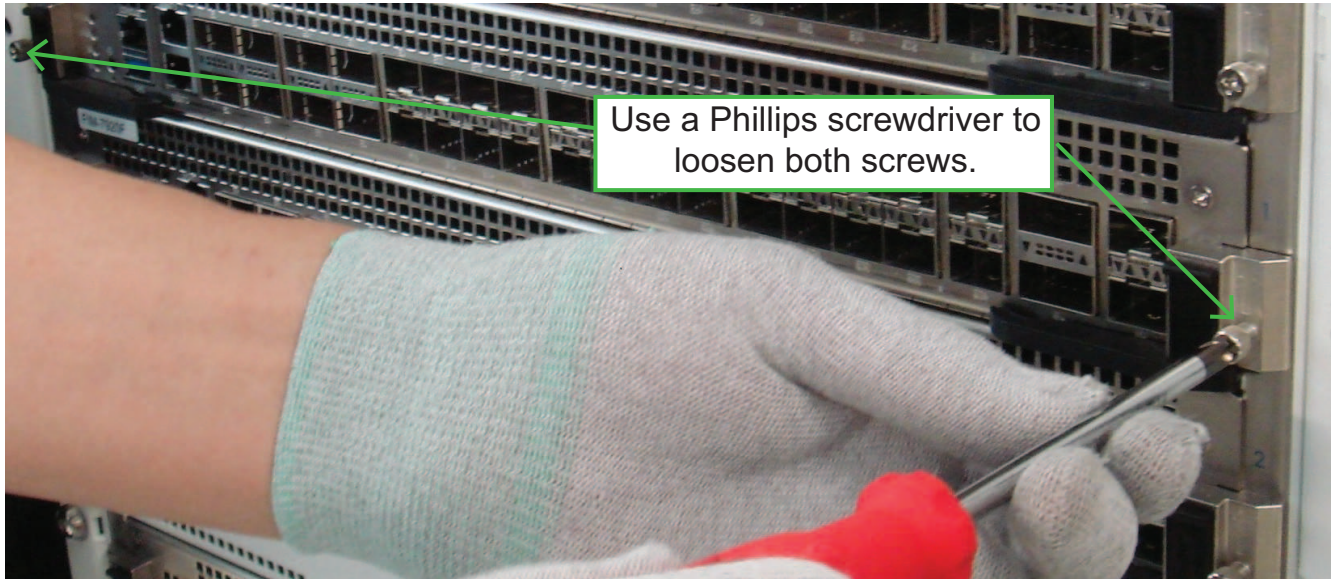

#### 4. Unlock the left and right levers by pushing the power sliders up until the levers pop open.

Push the power sliders up to fully open both levers. If the chassis is powered on, this step turns off the module's power.

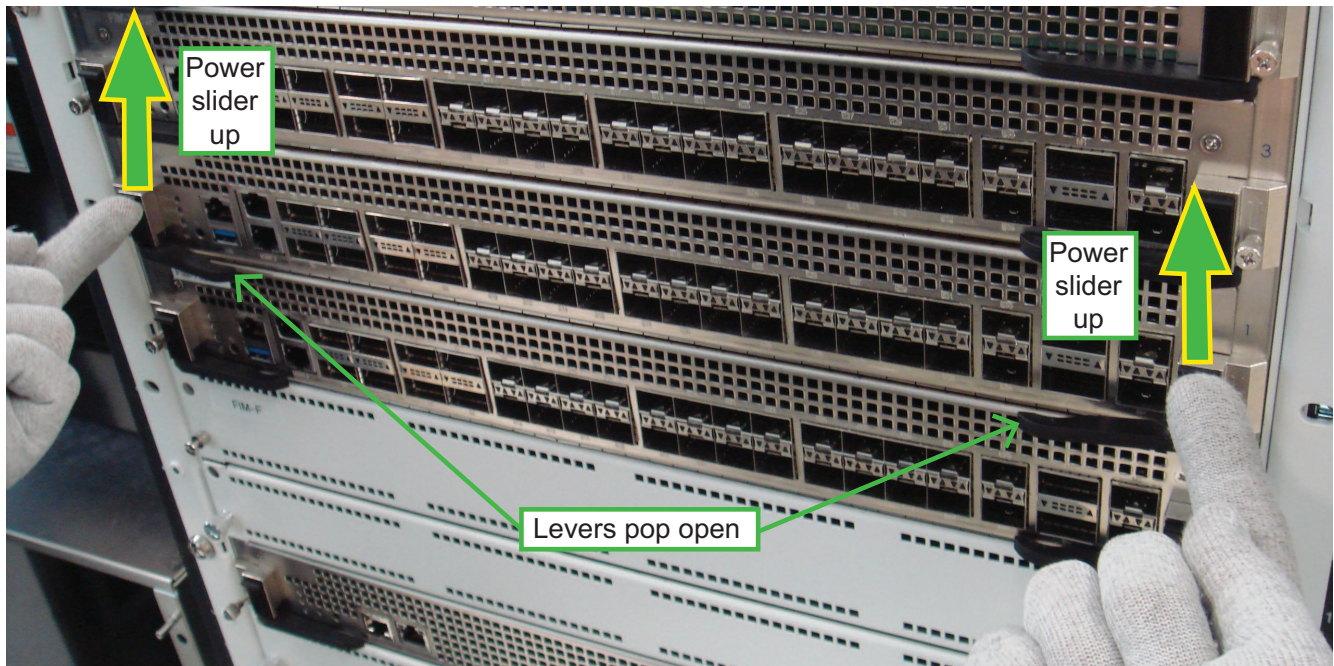



**5. Use moderate force to fully open the levers and eject the module from the chassis.**

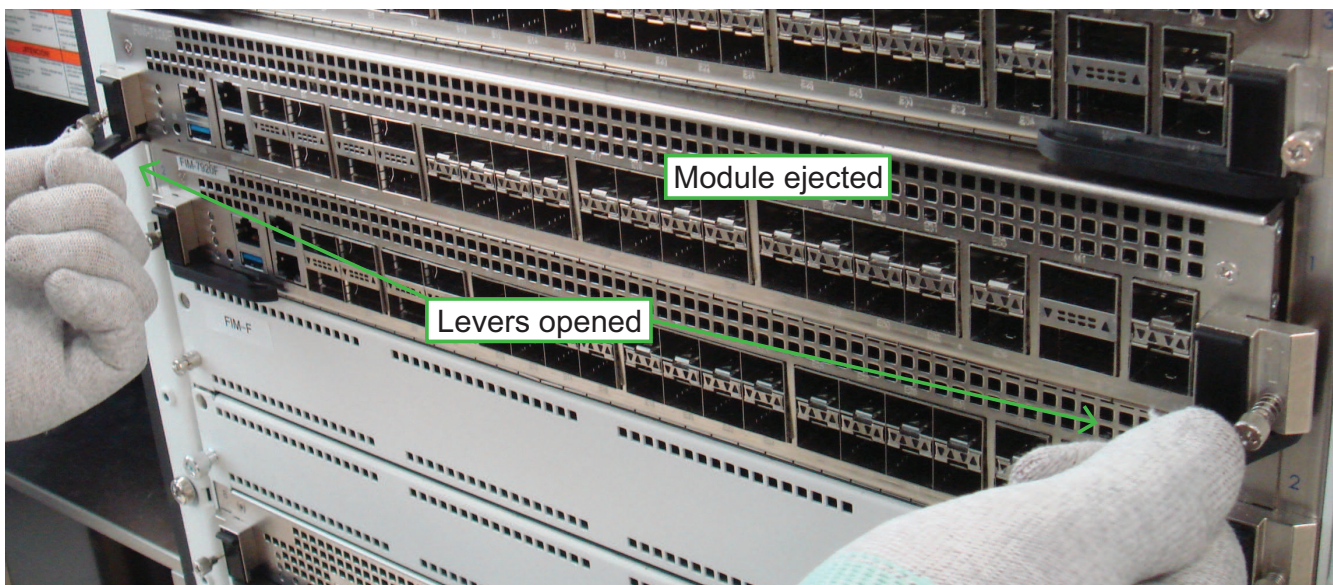
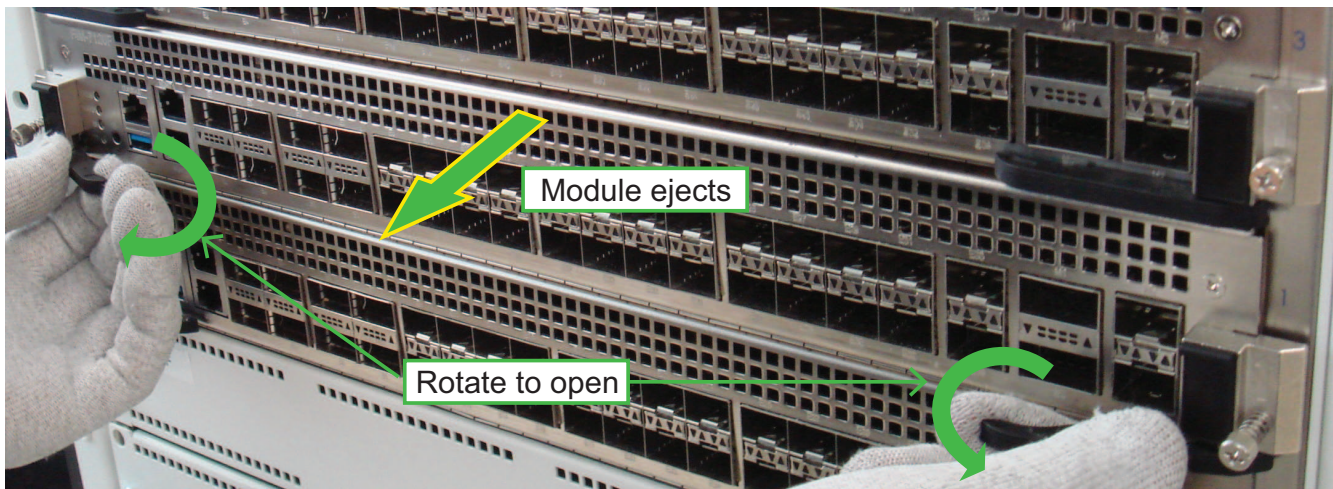

**6. Hold the levers to slide the module part way out of the chassis slot. Then grasp the module by the sides and carefully slide it out of the slot.**

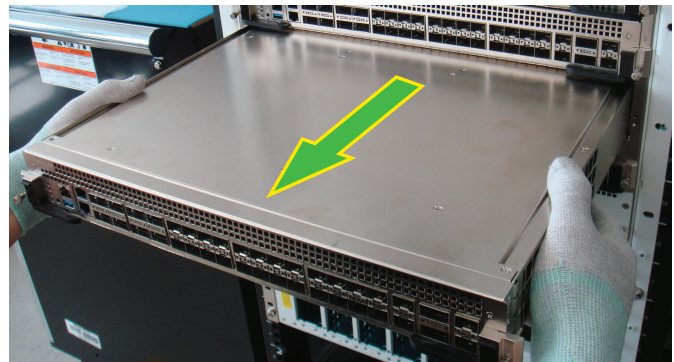

## Troubleshooting

This section describes some common troubleshooting topics:

### FIM-7901E does not startup

Positioning of FIM-7901E mounting hardware and a few other causes may prevent a FIM-7901E from starting up correctly.

#### Power sliders and module levers not fully closed

If the power sliders or module levers are damaged or positioned incorrectly, the FIM-7901E may not start up. Make sure the sliders are fully closed and the levers are correctly aligned, fully inserted, and locked and the secure screws are tightened.

#### Firmware problem

If the FIM-7901E is receiving power and the sliders and levers are fully closed, and you have restarted the chassis and the FIM-7901E still does not start up, the problem could be with FortiOS. Connect to the FIM-7901E console and try cycling the power to the board. If the BIOS starts up, interrupt the BIOS startup and install a new firmware image. See your FortiGate-7000 chassis system guide for information about accessing and installing firmware on individual modules.

If this does not solve the problem, contact Fortinet Technical Support.

### FIM-7901E status LED is flashing during system operation

Normally, the FIM-7901E Status LED is off when the FIM-7901E is operating normally. If this LED starts flashing while the module is operating, a fault condition may exist. At the same time the FIM-7901E may stop processing traffic.

To resolve the problem you can try removing and reinserting the FIM-7901E in the chassis slot. Reloading the firmware may also help.

If this does not solve the problem there may have been a hardware failure or other problem. Contact Fortinet Technical Support for assistance.

# Quick FIM-7901E configuration

This section is a quick start guide to connecting and configuring a FIM-7901E for your network.

Before using this chapter, your FortiGate-7000 chassis should be mounted and connected to your power system. In addition, your FIM-7901Es should be inserted into the chassis in slots 1 or 2 and one or more processor modules should be installed in chassis slots 3 and up. The chassis and the modules should also be powered up and the front panel LEDs should indicate that the modules are functioning normally. As well the FIM-7901E and the processor modules should be running the same FortiOS firmware version.

## Registering your FortiGate-7000 series products

FortiGate-7000 series products are registered according to the chassis serial number. You need to register your chassis to receive Fortinet customer services such as product updates and customer support. You must also register your product for FortiGuard services. Register your product by visiting <https://support.fortinet.com>. To register, enter your contact information and the serial numbers of the Fortinet products that you or your organization have purchased.

## Choosing the configuration tool

You can use either the GUI or the Command Line Interface (CLI) to configure the FIM-7901E. Some basic configuration settings can only be done from the CLI. You can connect to the GUI using HTTP or HTTPS, You can connect to the CLI using SSH or Telnet or by a direct console connection to the FIM-7901E Console port. Use a terminal emulator with the following settings to connect to the console port: bits per second: 9600, data bits: 8, parity: none, stop bits: 1, flow control: none.

## Changing network settings

The FIM-7901E ships with the following factory default configuration.

Option	Default configuration
Administrator Account User Name	admin
Password	(none) For security reasons you should add a password to the admin account before connecting the FIM-7901E to your network.
MGMT1 to MGMT4 IP/Netmask	192.168.1.99/24

MGMT 1 to MGMT 4 of each FIM-7901E are configured as a static aggregate interface called mgmt and all have the same IP address. If you have two FIM modules installed in your chassis, then MGMT 1 to MGMT 4 of both modules are all in the same static aggregate interface.

At any time during the configuration process, if you run into problems, you can reset the FIM-7901E to the factory defaults and start over. From the CLI enter `execute factoryreset`.

Connect to the GUI by connecting MGMT1 of the module in slot 1 to your network and browsing to <https://192.168.1.99>. Log into the GUI using the admin account with no password. Go to Network > Interface and configure the FIM-7901E interfaces to connect to your network.

# Cautions and warnings

## Environmental specifications

Ambient operating temperature: 0°C to 40°C

Rack Mount Instructions - The following or similar rack-mount instructions are included with the installation instructions:

Instructions de montage en rack - Les instructions de montage en rack suivantes ou similaires sont incluses avec les instructions d'installation:

**Elevated Operating Ambient** - If installed in a closed or multi-unit rack assembly, the operating ambient temperature of the rack environment may be greater than room ambient. Therefore, consideration should be given to installing the equipment in an environment compatible with the maximum ambient temperature (T<sub>ma</sub>) specified by the manufacturer.

**Température ambiante élevée** - S'il est installé dans un rack fermé ou à unités multiples, la température ambiante de fonctionnement de l'environnement du rack peut être supérieure à la température ambiante de la pièce. Par conséquent, il est important d'installer le matériel dans un environnement respectant la température ambiante maximale (T<sub>ma</sub>) stipulée par le fabricant.

**Reduced Air Flow** - Installation of the equipment in a rack should be such that the amount of air flow required for safe operation of the equipment is not compromised.

**Ventilation réduite** - Installation de l'équipement dans un rack doit être telle que la quantité de flux d'air nécessaire au bon fonctionnement de l'équipement n'est pas compromise.

**Mechanical Loading** - Mounting of the equipment in the rack should be such that a hazardous condition is not achieved due to uneven mechanical loading.

**Chargement Mécanique** - Montage de l'équipement dans le rack doit être telle qu'une situation dangereuse n'est pas liée à un chargement mécanique inégal.

**Circuit Overloading** - Consideration should be given to the connection of the equipment to the supply circuit and the effect that overloading of the circuits might have on overcurrent protection and supply wiring. Appropriate consideration of equipment nameplate ratings should be used when addressing this concern.

**Surtension** - Il convient de prendre l'ensemble des précautions nécessaires lors du branchement de l'équipement au circuit d'alimentation et être particulièrement attentif aux effets de la suralimentation sur le dispositif assurant une protection contre les courts-circuits et le câblage. Ainsi, il est recommandé de tenir compte du numéro d'identification de l'équipement.

**Reliable Earthing** - Reliable earthing of rack-mounted equipment should be maintained. Particular attention should be given to supply connections other than direct connections to the branch circuit (e.g. use of power strips).

**Fiabilité de la mise à la terre** - Fiabilité de la mise à la terre de l'équipement monté en rack doit être maintenue. Une attention particulière devrait être accordée aux connexions d'alimentation autres que les connexions directes au circuit de dérivation (par exemple de l'utilisation de bandes de puissance).

Equipment must be used only with UL Listed ITE or Equivalent.

L'équipement doit être utilisé uniquement avec UL ITE ou équivalent.



*Refer to specific Product Model Data Sheet for Environmental Specifications (Operating Temperature, Storage Temperature, Humidity, and Altitude).*

*Référez à la Fiche Technique de ce produit pour les caractéristiques environnementales (Température de fonctionnement, température de stockage, humidité et l'altitude).*

## Safety

**Moving parts** - Hazardous moving parts. Keep away from moving fan blades.

**Pièces mobiles** - Pièces mobiles dangereuses. Se tenir éloigné des lames mobiles du ventilateur.

**Warning:** Equipment intended for installation in Restricted Access Location.

**Avertissement:** Le matériel est conçu pour être installé dans un endroit où l'accès est restreint.

**Battery** - Risk of explosion if the battery is replaced by an incorrect type. Do not dispose of batteries in a fire. They may explode. Dispose of used batteries according to your local regulations. IMPORTANT: Switzerland: Annex 4.10 of SR814.013 applies to batteries.

**Batterie** - Risque d'explosion si la batterie est remplacée par un type incorrect. Ne jetez pas les batteries au feu. Ils peuvent exploser. Jetez les piles usagées conformément aux réglementations locales. IMPORTANT: Suisse: l'annexe 4.10 de SR814.013 s'appliquent aux batteries.

警告

本電池如果更換不正確會有爆炸的危險

請依製造商說明書處理用過之電池

**CAUTION:** There is a danger of explosion if a battery is incorrect replaced. Replace only with the same or equivalent type. Dispose batteries of according to the manufacturer's instructions. Disposing a battery into fire, a hot oven, mechanically crushing, or cutting it can result in an explosion. Leaving a battery in an extremely hot environment can result in leakage of flammable liquid, gas, or an explosion. If a battery is subjected to extremely low air pressure, it may result in leakage of flammable liquid, gas, or an explosion.

**WARNUNG:** Lithium-Batterie Achtung: Explosionsgefahr bei fehlerhafter Batteriewechsel. Ersetzen Sie nur den gleichen oder gleichwertigen Typ. Batterien gemäß den Anweisungen des Herstellers entsorgen.

Beseitigung einer BATTERIE in Feuer oder einen heißen Ofen oder mechanisches Zerkleinern oder Schneiden einer BATTERIE, die zu einer EXPLOSION führen kann.

Verlassen einer BATTERIE in einer extrem hohen Umgebungstemperatur, die zu einer EXPLOSION oder zum Austreten von brennbarer Flüssigkeit oder Gas führen kann.

Eine BATTERIE, die einem extrem niedrigen Luftdruck ausgesetzt ist, der zu einer EXPLOSION oder zum Austreten von brennbarer Flüssigkeit oder Gas führen kann.

**Caution:** Slide/rail mounted equipment is not to be used as a shelf or a work space.

**Attention:** Un équipement monté sur bâti ne doit pas être utilisé sur une étagère ou dans un espace de travail.

Fiber optic transceiver must be rated 3.3V, 22mA max, Laser Class 1, UL certified component.

Le transceiver optique doit avoir les valeurs nominales de 3.3 V, maximum 22 mA, Laser Class 1, homologué UL

# Regulatory notices

## Federal Communication Commission (FCC) – USA

This device complies with Part 15 of FCC Rules. Operation is subject to the following two conditions:

- (1) this device may not cause harmful interference, and
- (2) this device must accept any interference received; including interference that may cause undesired operation.

This equipment has been tested and found to comply with the limits for a Class A digital device, pursuant to Part 15 of the FCC Rules. These limits are designed to provide reasonable protection against harmful interference when the equipment is operated in a commercial environment. This equipment generates, uses, and can radiate radio frequency energy, and if it is not installed and used in accordance with the instruction manual, it may cause harmful interference to radio communications. Operation of this equipment in a residential area is likely to cause harmful interference, in which case the user will be required to correct the interference at his own expense.

**WARNING:** Any changes or modifications to this product not expressly approved by the party responsible for compliance could void the user's authority to operate the equipment.

## Industry Canada Equipment Standard for Digital Equipment (ICES) – Canada

CAN ICES-3 (A) / NMB-3 (A)

This digital apparatus does not exceed the Class A limits for radio noise emissions from digital apparatus set out in the Radio Interference Regulations of the Canadian Department of Communications.

Cet appareil numérique n'émet pas de bruits radioélectriques dépassant les limites applicables aux appareils numériques de la classe A prescrites dans le Règlement sur le brouillage radioélectrique édicté par le ministère des Communications du Canada.

## European Conformity (CE) - EU

This is a Class A product. In a domestic environment, this product may cause radio interference, in which case the user may be required to take adequate measures.



## Voluntary Control Council for Interference (VCCI) – Japan

この装置は、クラスA機器です。この装置を住宅環境で使用すると電波妨害を引き起こすことがあります。この場合には使用者が適切な対策を講ずるよう要求されることがあります。VCCI-A

## Bureau of Standards Metrology and Inspection (BSMI) – Taiwan

The presence conditions of the restricted substance (BSMI RoHS table) are available at the link below:

限用物質含有情況表 (RoHS Table) 請到以下網址下載:

<https://www.fortinet.com/bsmi>

此為甲類資訊技術設備，於居住環境中使用時，可能會造成射頻擾動，在此種情況下，使用者會被要求採取某些適當的對策。

英屬蓋曼群島商防特網股份有限公司台灣分公司

地址：台北市內湖區行愛路176號2樓

電話：(02) 27961666

## China

此为A级产品，在生活环境中，该产品可能会造成无线电干扰。这种情况下，可能需要用户对其采取切实可行的措施。





**FORTINET**<sup>®</sup>

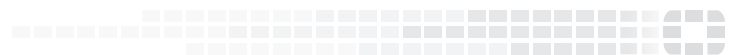

Copyright© 2019 Fortinet, Inc. All rights reserved. Fortinet®, FortiGate®, FortiCare® and FortiGuard®, and certain other marks are registered trademarks of Fortinet, Inc., in the U.S. and other jurisdictions, and other Fortinet names herein may also be registered and/or common law trademarks of Fortinet. All other product or company names may be trademarks of their respective owners. Performance and other metrics contained herein were attained in internal lab tests under ideal conditions, and actual performance and other results may vary. Network variables, different network environments and other conditions may affect performance results. Nothing herein represents any binding commitment by Fortinet, and Fortinet disclaims all warranties, whether express or implied, except to the extent Fortinet enters a binding written contract, signed by Fortinet's General Counsel, with a purchaser that expressly warrants that the identified product will perform according to certain expressly-identified performance metrics and, in such event, only the specific performance metrics expressly identified in such binding written contract shall be binding on Fortinet. For absolute clarity, any such warranty will be limited to performance in the same ideal conditions as in Fortinet's internal lab tests. In no event does Fortinet make any commitment related to future deliverables, features or development, and circumstances may change such that any forward-looking statements herein are not accurate. Fortinet disclaims in full any covenants, representations, and guarantees pursuant hereto, whether express or implied. Fortinet reserves the right to change, modify, transfer, or otherwise revise this publication without notice, and the most current version of the publication shall be applicable.