



Administration Guide

FortiSandbox 5.0.3



FORTINET DOCUMENT LIBRARY

<https://docs.fortinet.com>

FORTINET VIDEO LIBRARY

<https://video.fortinet.com>

FORTINET BLOG

<https://blog.fortinet.com>

CUSTOMER SERVICE & SUPPORT

<https://support.fortinet.com>

FORTINET TRAINING & CERTIFICATION PROGRAM

<https://www.fortinet.com/training-certification>

FORTINET TRAINING INSTITUTE

<https://training.fortinet.com>

FORTIGUARD LABS

<https://www.fortiguard.com>

END USER LICENSE AGREEMENT

<https://www.fortinet.com/doc/legal/EULA.pdf>

FEEDBACK

Email: techdoc@fortinet.com



February 11, 2026

FortiSandbox 5.0.3 Administration Guide

34-503-1147452-20260211

TABLE OF CONTENTS

Change Log	8
Introduction	9
FortiSandbox overview	9
What's new in FortiSandbox v5.0.0	9
Advanced AI	9
Universal VM	9
SOC assist	10
Key Features	11
Dashboard	12
Status (Main Dashboard)	12
System Information	13
Upload license	14
Connectivity and services widget	15
Scan Performance (dashboard)	17
FortiGuard statistics	18
Incident Assist	19
Displayed Columns	19
Available Actions	20
Incident Actions Pane	20
Information and Logs	21
Search and Filtering	22
Customize the Dashboard	23
Scan Performance (widget)	24
System Resources	25
Scan Statistics	26
File Scan	27
Top Devices	27
Pending Job Statistics	28
Top Critical Logs	28
Sniffer Traffic	28
Threats Distribution	28
Quick Download	28
Runtime Usage	28
Administrative task alert notifications	29
Scan mode	29
Security Fabric	31
Device	31
Supported Devices	33
Adapter	43
ICAP adapter	44
BCC Adapter	49
MTA adapter	52
Network Share	55
Network share record retention	59

Skip scanning unchanged files after first round of scan	59
Scan Details	59
Quarantine	60
Sniffer	63
FortiNDR	66
Scan Job	68
Job Queue	68
VM Jobs	69
File Job	70
URL Job	72
Overridden Verdicts	74
File On-Demand	74
URL On-Demand	80
Cloud storage	84
AWS S3 Settings	87
Azure File System	88
Azure Blob Storage	88
Google Cloud	91
Microsoft OneDrive	97
Microsoft SharePoint	101
Scan Policy and Object	105
Scan Profile	105
File types	105
Scan Profile Pre-Filter Tab	106
Scan Profile VM Association Tab	108
Scan Profile Advanced Tab	110
File Scan Priority	115
File Scan Flow	115
URL Scan Flow	115
VM Settings	116
VM types	117
Configuring VM settings	122
Setting up a custom VM	126
OT Simulation	128
Job Priority	129
Job Archive	130
Allowlist and blocklist	131
Web Category	133
Using URL Pre-Filter settings	134
Customized Rating	135
YARA Rules	136
Format guidelines for regular YARA Rules	137
Format guidelines for process memory YARA Rules	140
Malware Package	141
URL Package	142
TCP RST package	143

Threat Intelligence	144
Malware and URL Package Options	144
IOC Package	147
Global Network	148
System	151
Administrators	152
Admin Profiles	156
Pre-defined profile types	156
Data access	156
Menu Access	156
API/CLI Access	159
Wildcard Admin Authentication	159
Device Groups	160
Netshare Groups	161
Password Policy	162
Password Best Practices	164
Interfaces	164
Edit an interface	166
Edit administrative access	166
Create an aggregate interface	167
Failover IP	169
Create an API Interface	170
DNS Configuration	170
Static Route	171
LDAP Servers	172
SAML SSO	174
SAML SSO login FortiSandbox with Microsoft Entra ID acting as SAML IdP	175
SAML SSO login FortiSandbox with FortiAuthenticator acting as SAML IdP	182
SAML SSO in HA cluster	187
RADIUS Servers	188
Mail Servers	189
FortiGuard	192
Advanced AI	192
Real Time Anti-Phishing	194
Sandbox Community Cloud	195
Certificates	195
Netshare keys	197
Login Disclaimer	197
SNMP	198
Configuring the SNMP agent	198
MIB files	201
System Recovery	201
Local Backup	202
Remote Backup	202
Restore	203
Event Calendar	204

Event Calendar Settings	205
Job View Settings	205
Settings	206
Additional information	208
HA cluster	210
Cluster setup	211
HA cluster pre-requisites	212
Example configuration	213
Switching the HA mode	215
Cluster level failover IP	216
Health Check	216
Using an aggregate interface	218
Deploying primary and secondary nodes without VM Clones	218
Cluster Management	218
Job Summary	220
Managing worker nodes	221
HA Roles, Synchronization and Failover	222
Primary and worker roles	223
Heartbeat Synchronization	225
Failover scenarios	226
Performance tuning	227
Setting primary node processing capacity	227
Upgrading or rebooting a cluster	227
Main HA cluster CLI commands	228
Log & Report	229
Log Details	229
Logging Levels	229
Raw logs	230
Log Categories	230
Viewing logs in FortiAnalyzer	232
Customizing the log view	233
Columns	233
Summary Reports	234
Generate reports	234
Report Center	235
Customize Report	236
Network Alerts	237
Log Servers	239
Settings (Log & Report)	240
Appendix A - Advanced deployment scenarios	242
Deploying primary and secondary nodes without VM Clones	242
Deploying for Static Scan only	242
Deploying for OT Industry	242
Appendix B- Job Details page reference	244
Overview tab	245
Basic Information	245

Analysis over time	247
Behavior tab	248
Details	248
Tree View	250
Screenshots	251
Download	251
Threat Intelligence tab	251
Key Highlights	252
Threat Enrichment via FortiGuard IOC	252
Threat IOC Table	252
ATT&CK Matrix	252
Appendix C - Malware types	253
Appendix D - Maximum values	255
Configuration limits	255
File size limits	257
Client device connections	258
Appendix E - Job risk rating	259
Appendix F: FortiSandbox PaaS supported features	261
Appendix G: FortiSandbox Lite Mode	263

Change Log

Date	Change Description
2025-08-13	Initial release of 5.0.3.
2025-08-19	Updated Appendix D - Maximum values on page 255 .
2025-08-22	Updated Appendix B- Job Details page reference on page 244 and File types on page 105 .
2025-0-17	Updated System Resources on page 25 .
2025-11-5	Updated VM Settings on page 116 and Configuring VM settings on page 122 .
2025-12-11	Updated FortiGuard on page 192 .
2026-02-11	Updated Cluster Management on page 218

Introduction

This guide describes how to configure and manage your FortiSandbox system and the connected Fortinet Security Fabric devices. For documentation on Fortinet devices, such as FortiGate and FortiClient, see [Fortinet Document Library](#).

FortiSandbox overview

Combating today's Advanced Persistent Threats (APTs) demands a multi-layered strategy. FortiSandbox provides an exceptional blend of proactive defense, enhanced threat visibility, and thorough reporting. It's more than just a sandbox; it incorporates Fortinet's award-winning AI-based threat scanning technologies, dynamic sandboxing, and optional integrated FortiGuard cloud queries to counter advanced evasion techniques and deliver cutting-edge threat protection. FortiSandbox utilizes AI-based advanced detection and threat scanning technology to detect unknown Malware and Phishing, counter advanced evasion techniques and deliver cutting-edge threat protection. FortiSandbox works with your existing devices, such as FortiGate, FortiMail, FortiClient and several other security fabric devices to identify malicious and suspicious files and network traffic. It has a complete extreme antivirus database that will catch viruses that may have been missed.

FortiSandbox executes suspicious files in the VM host module to determine if the file is High, Medium, or Low Risk based on the behavior observed in the VM sandbox module. The rating engine scores each file from its behavior log (tracer log) that is gathered in the VM module and, if the score falls within a certain range, a risk level is determined.

What's new in FortiSandbox v5.0.0

Advanced AI

Advanced AI enhances detection coverage with next-generation static and dynamic scanning. Leveraging two scan engines, Advanced AI builds on FortiSandbox's already fast and reliable scanning abilities with ten-times faster verdicts and three-times detection and accuracy . For more information, refer to [FortiGuard on page 192](#).

Universal VM

Universal VM provides access to multiple VMs with just a single license type. This new all-in-one license supports deployment on premise or cloud VMs for any supported OS. Deploy as many as 200 flexible VMs on a single unit, making ultra scalable and cost effective. For more information, refer to [Scan Policy and Object > VM Settings on page 116](#).

SOC assist

SOC Assist emboldens your SOC teams' investigation and threat hunting abilities with FortiSandbox's enhanced Threat Enrichment, Job Reports, and Incident Assist. Threat Enrichment is correlated analysis to known outbreaks, threat actors and attack campaigns for more decisive investigations. The enhanced Job Report is an AI-generated summary of events with comprehensive behavior trees and detailed activity tables. The Incident Assist provides unified threat monitoring for daily review of detected threats from a single page view.

Key Features

Key features of FortiSandbox include:

- Dynamic Anti-malware updates/Cloud query: Receives updates from FortiGuard Labs and send queries to the FortiSandbox Community Cloud in real time, helping to intelligently and immediately detect existing and emerging threats.
- Full virtual environment: Provides a contained runtime environment to analyze high risk or suspicious code and explore the full threat life cycle.
- Advanced visibility: Delivers comprehensive views into a wide range of network, system and file activity, categorized by risk, to help speed up incident response.
- Network Alert: Inspects network traffic for requests to visit malicious sites, establish communications with C&C servers, and other activity indicative of a compromise. It provides a complete picture of the victim host's infection cycle.
- Manual analysis: Allows security administrators to manually upload malware samples via the FortiSandbox web GUI or JSON API to perform virtual sandboxing without the need for a separate appliance.
- FortiSandbox Community Cloud: Tracer reports, malicious files and other information may be submitted to FortiSandbox Community Cloud in order to receive remediation recommendations and updated in line protections.
- Schedule scan of network shares: Perform a schedule scan of network shares in Network File System (NFS) v2 to v4 and Common Internet File System (CIFS) formats to quarantine suspicious files.
- Scan job archive: You can archive scan jobs to a network share for backup and further analysis.
- Website URL scan: Scan websites to a certain depth for a predefined time period.
- Cluster supporting High Availability: Provide a non-interruption, high performance system for malware detection. Custom VMs using pre-configured VMs with your own ISO image.

For information on advanced guidelines (e.g. hard disk hot-swapping procedure, system recovery procedure using Rescue Mode, and password reset procedure), see the [FortiSandbox Best Practices and Troubleshooting Guide](#) in the Fortinet Document Library. And for information on cloud-based deployments, see <https://docs.fortinet.com/product/fortisandbox-cloud/>.

Dashboard

FortiSandbox comes with predefined dashboards that display information about your device, system performance, and statistics about recent activity.

- [Status \(Main Dashboard\) on page 12](#)
- [Scan Performance \(dashboard\) on page 17](#)
- [FortiGuard statistics on page 18](#)
- [Incident Assist on page 19](#)
- [Customize the Dashboard on page 23](#)
- [Administrative task alert notifications on page 29](#)

Status (Main Dashboard)

Dashboard > Status displays widgets that provide system information and enable you to configure basic system settings. All widgets appear in the *Dashboard > Status* page which you can customize.

When the machine boots up and is logged into for the first time, a *System Not Ready* message will appear at the bottom of the *System Information* widget and at the top-right corner of the *Status* page until the system is ready.

If the unit is the primary node in a cluster, the displayed data shows a summary of all nodes in the cluster.

The following widgets are available:

System Information	Displays basic information about the FortiSandbox system, such as the serial number and system up time.
Connectivity and Services	Displays connectivity and services.
Scan Performance	Displays scan performance over a period of time. Click the number next to the security verdict to view the job list.
System Resources	Displays the real-time usage status of the CPU, memory, and disk usage.
Scan Statistics	Displays information about files/URLs scanned over a time period, This including Sniffer, Devices, On-Demand, Network, Adapter, and URL.
File Scan	Displays the number of clean, suspicious, and malicious events that occurred at specific times over a time period. Hover the pointer over a colored portion of a bar in the graph to view the number of events of the selected type that occurred.
Top Devices	Displays the total scanning jobs for the top five devices over a time period. Hover the pointer over a bar in the graph to view the number of scanning jobs for that device.

Pending Job Statistics	Displays pending scan job numbers over a time period. This widget allows you to monitor the workload trend on your FortiSandbox.
Top Critical Logs	Displays recent critical logs, including the time they occurred and a brief description.
Sniffer Traffic	Displays sniffed traffic throughput across time.
Threats Distribution	Displays threat level distribution over two customized time intervals.
File Quick Download	To quickly search for a file according to its checksum. If found, the user can download the file, download the PDF report, and view job detail.
Runtime Usage	Displays system resources usage over a time period, including CPU, memory, and disk usage.

System Information

The *System Information* widget displays information about FortiSandbox and enables you to configure basic system settings. It contains links to the *Settings* module, where you can update the system time, change the hostname, copy the serial number, and other settings.

A notification will appear at the bottom of the widget when a new version of FortiSandbox is released. Click *Update firmware* to view the available versions and update FortiSandbox.

The screenshot shows the 'System Information' widget with a settings menu open. The widget displays the following information:

Firmware Version	v5.0.3
Model	FortiSandbox
Hostname	FS-XXXXXX
System Configuration	Local
Serial Number	FS-XXXXXX
Username	admin
Unit Type	Standalone
System Time	2024-10-18 16:02:45 PDT
Uptime	18m 53s

The settings menu includes the following options:

- Change Time Settings
- Update Firmware
- Backup/Restore Configuration
- Change Hostname
- Upload Windows/Office License
- Open FortiGuard page
- Copy Serial Number

Firmware Version	The version, build number, and the date of the firmware installed on the FortiSandbox unit.
-------------------------	---

	When new firmware is available, a notification stating <i>There is new firmware available</i> will be displayed at the bottom of the widget. Clicking the notification and selecting the option will redirect you to a page where you can download and install available firmware, or manually upload firmware. You can also choose to create backup configurations.
Model	Displays the FortiSandbox model.
Hostname	The name assigned to this FortiSandbox unit. Click the widget and select <i>Change Hostname</i> to edit the FortiSandbox host name.
Serial Number	The serial number of this FortiSandbox unit. The serial number is unique to the FortiSandbox unit and does not change with firmware upgrades. The serial number is used for identification when connecting to the FortiGuard server.
Backup/Restore Configuration	The date and time of the last system configuration backup. Click the widget then select <i>Backup/Restore Configuration</i> to go to the <i>System Recovery</i> page.
System Time	The current time on the FortiSandbox internal clock or NTP server. Click the widget then select <i>Change Time Settings</i> to configure the system time. When using the <i>Nearest FDN</i> server option, it is important to set the correct time zone for FortiSandbox according to its physical location. This setting ensures that FortiSandbox connects to the closest FDN server based on the time zone. An incorrect time zone may cause FDN updates to be slower or fail.
Unit Type	The HA cluster status of the device: <i>Standalone, Primary, Secondary, or Worker</i> . In an HA cluster, click the widget then select <i>Change Unit Type</i> option to change the cluster status of the device. If the rating engine is not available or out-of-date, a red blinking <i>No Rating Engine</i> message appears. There is also a <i>No Tracer Engine</i> notification that appears at the bottom of the page. Clicking the notification will redirect you to the <i>System > FortiGuard</i> page.
Uptime	The duration of time that the FortiSandbox unit has been running since boot up.
Username	The administrator that is currently logged in.

Upload license

On VM models, click the *System Information* widget and select the *Upload VM License* option to install the license. The system reboots and activates the newly installed VM license.

On hardware models, click the *System Information* widget and select the *Upload Windows/Office* license option to install the license. The system does not require a reboot and will activate the newly installed Windows guest VMs.



On FortiSandbox hardware units, the *Upload License* icon can accept the Microsoft Windows license file, Microsoft Office license file, and Microsoft Windows & Office license file as FSA-VM.

Connectivity and services widget

Licenses

The *VM Readiness* and *FortiGuard Service* icons in the *Connectivity and Services* widget display information about the licensing status and server accessibility of your FortiSandbox unit.

Hover your mouse over the status icon to view the license status and details.

Antivirus	The date that the antivirus database contract expires. If the contract expires within 15 days, a caution icon appears.
Customized VM	Customized VM license activation and initialization status.
Mail Transfer Agent Service	Mail Transfer Agent Service license activation and initialization status.
Microsoft Office	Microsoft Office product activation status. The active icon and caution icon can both appear when Microsoft Office software is activated on some enabled VMs but not activated on other enabled VMs. For more information, see <i>Log & Report > Events > VM Events</i> .
Real-time Zero-Day Anti-Phishing Service	Status of the Real-time Zero-Day Anti-Phishing Service Server.
Web Filtering	Status of the Web Filtering query server.
Windows Cloud VM	In a cluster environment, each VM00 unit in the cluster can purchase Windows cloud VM seat counts to expand the cluster's scan power. These cloud VM clones are local to that VM00 unit and are not shared.
Windows VM	Microsoft Windows VM license activation and initialization status. For more information, see <i>Log & Report > Events > VM Events</i> . In addition to the pre-installed default set of Windows VM images, you can also download, install, and use optional images from the <i>Optional VMs</i> section in the <i>VM Image</i> page. Extra Windows OS licenses might be needed if the unit has none available. For example, when you try to use a Windows 10 image on a FortiSandbox unit, you might need to purchase Windows 10 license keys from Fortinet. After purchase, download your license file from the Fortinet Customer Service & Support portal. Then use the <i>Upload License</i> link next to the Windows VM field to install the license. The system reboots and activates the newly-installed Windows guest VMs.

Connectivity and services information

The following service information is displayed:

FortiGuard Services	
AI	License status of AI Engine and Model.
Anti-Phish	License and configure Status of the Real-time Zero-Day Anti-Phishing Service.
Antivirus	The date that the antivirus database contract expires. If the contract expires within 15 days, a caution icon appears.
Cloud VM	In a cluster environment, each VM00 unit in the cluster can purchase Windows cloud VM seat counts to expand the cluster's scan power. These cloud VM clones are local to that VM00 unit and are not shared.
Community	Configuration and server connection status of Community Cloud Server.
Custom VM	Customized VM activation and initialization status.
Engines	Installation status of FortiSandbox tracer and rating engine
FDN	Status of FDN download server.
MS Office	Microsoft Office product activation status. The active icon and caution icon can both appear when Microsoft Office software is activated on some enabled VMs but not activated on other enabled VMs. For more information, see Log & Report > Events > VM Events.
Universal VM	License status of Universal VM.
VM Image	Status of FortiGuard VM Image Server connection.
VM Internet	Status of the FortiSandbox guest VM accessing the outside network. This section only displays VMs that are enabled.
VM Readiness	
Web Filtering Query	Status of the Web Filtering query server.
Win VM	Microsoft Windows VM license activation and initialization status. For more information, see Log & Report > Events > VM Events. In addition to the pre-installed default set of Windows VM images, you can also download, install, and use optional images from the Optional VMs section in the VM Image page. Extra Windows OS licenses might be needed if the unit has none available. For example, when you try to use a Windows 10 image on a FortiSandbox unit, you might need to purchase Windows 10 license keys from Fortinet. After purchase, download your license file from the Fortinet Customer Service & Support portal. Then use the <i>Upload License</i> option in the <i>System Information</i> widget to install the license. The system reboots and activates the newly-installed Windows guest VMs.

Security Fabric	
BCC	Icon displayed when enabled the configuration, indicating the status of the BCC job submission.
Device	Using different colors and tooltips to display devices connection, authorized status.
FAZ	Status of FortiAnalyzer servers' connections
FortiClient	Using different colors and tooltips to display FortiClient connection and authorized status.
FortiNDR	Icon displayed when FortiNDR is enabled. Using different colors to display FortiNDR connection status
ICAP	Icon displayed when configured ICAP. Different colors indicate the license and submission status.
MTA	Mail Transfer Agent Service license activation and initialization status. Icon is displayed when MTA is configured. Colors indicate the license and submission status.
NetShare	Icon displayed when network share has been configured. Using different colors to display connections access status.

This widget displays information about connectivity and services. The icon color indicates whether the service is up, inaccessible, or not configured, as well as whether the license is valid, expired or not licensed.

FortiGuard Service	<ul style="list-style-type: none"> • Green: The service is enabled and accessible or connected with a valid license. • Red: The service is inaccessible or disconnected. The service is either inaccessible, disconnected, expired or not license. • Gray: The service is neither configured nor enabled.
Security Fabric	<ul style="list-style-type: none"> • Green: The feature is configured, accessible and has job submission. • Red: The feature is configured, but unauthorized, unreachable, unlicensed, expired, or inactive in the last 24 hours. • Gray: There is no device attached. • An icon is not displayed when the feature is disabled or not configured.
VM Readiness	<ul style="list-style-type: none"> • Green: The VM is activated and initialized. The license is valid. The server is accessible. • Red: The VM has activation or initialization issue. The license is expired. The server is inaccessible. • Gray: The VM is neither enabled nor license. SIMNET is using.

Scan Performance (dashboard)

The *Scan Performance* dashboard tracks the FortiSandbox performance over time. The data is similar to the *Scan Performance* widget and is accumulated every 10 minutes. The page is automatically refreshed every 5

minutes. To view the Scan Performance dashboard, go to *Dashboard > Scan Performance*.

The options for the unit of time will vary based on the time range. For example, the hourly view **H** is displayed in shorter time ranges (*1 day, 3 days and 7 days*), whereas the day view **D** is displayed in longer ranges (*4 weeks and 1 Year*).

The *Scan Performance* dashboard contains the following charts:

Scanned Count	The total number of scanned jobs per time unit.
VM Scan count	The total number of jobs that entered the VM for dynamic scan per time unit.
Average Processing Wait Time	The wait time in the initial processing queue.
Average VM Wait time	The wait time prior to entering the VM for dynamic scan based on the average calculated time divided by total jobs per time unit.
Average Process Time	The processing time from receiving to completing the scan based on the average calculated time divided by total jobs per time unit.
Average VM Scan Time	The processing time within the VM for dynamic scan based on the average calculated time divided by total jobs per time unit.

FortiGuard statistics

FortiGuard Statistics provide insights into phishing and malware threats detected globally and locally over the past 7 days. They help identify top phishing targets, categories, and trends, enabling better threat awareness and response. Widgets display data such as daily detections, recent threats, and top malware or suspicious URL categories.

The dashboard groups related widgets and insights as follows:

Global Statistics - Last 7 days

Widget	Description
Top 5 Phishing Targets Globally	Displays the statistics of the top 5 phishing targets from global RTAP data within the past 7 days.
Top 5 Phishing Categories Globally	Displays the statistics of the top 5 phishing categories from global RTAP data within the past 7 days.

Local Phishing Statistics - Last 7 days

Widget	Description
Top 5 Phishing Targets Detected	Displays statistics for the top 5 phishing targets identified by local scans within the past 7 days. Clicking a piece in the chart will display the job list with details.
Daily Phishing Detections	Displays the daily job count of phishing threats detected by local scans within the past 7 days.
Recent Phishing Detections	Displays the 10 most recent phishing detections, including target names and URLs. Use the expand arrow at the bottom to view all 10 entries. Clicking a job opens detailed information in a new tab.

Local Detections by Category- Last 7 days:

Widget Name	Description
Top 5 0-Day Malware Categories	Displays the top 5 zero-day malware categories detected by local scan within the last 7 days.
Top 5 suspicious URL Categories	Displays the top 5 suspicious URL categories detected by local scan within the last 7 days.
Detected Threats (Malware Categories/Suspicious URL Categories)	Displays the daily zero-day malware and suspicious URL categories detected within the last 7 days.

Click the *Refresh* icon at the top-left of each section to refresh the data. The top-right corner displays the date and time the data was *Last Updated*. Hover over a piece of the pie or bar charts to view detailed tips. For local detections, click a piece in the chart to view the jobs list.

Incident Assist

Incident Assist is a centralized monitoring platform designed to provide administrators and Security Operation Center (SOC) teams with real-time visibility into potential threats. This page focuses on analyzing files submitted via device, excluding those submitted on-demand or via RPC, and lists those flagged as suspicious or identified as malware. The page refreshes every three minutes, ensuring up-to-date information for monitoring. By reviewing the statuses of these files and accessing detailed reports, admins can better understand the nature of the threats and take immediate action to mitigate risks. *Incident Assist* serves as a crucial tool for enhancing security response and safeguarding the organization's digital environment.

Displayed Columns

The main interface displays the following columns:

Incident Time	Displays the timestamp when the file was flagged.				
File Name	Lists the name of the file that was scanned. Beside the filename, an icon will appear to indicate the following: <table border="1" data-bbox="560 336 1458 472"> <tr> <td>In Signature</td> <td>The malware is included in the current FortiSandbox generated Malware Package.</td> </tr> <tr> <td>Archived File</td> <td>An icon appears if the file is an archived file.</td> </tr> </table>	In Signature	The malware is included in the current FortiSandbox generated Malware Package.	Archived File	An icon appears if the file is an archived file.
In Signature	The malware is included in the current FortiSandbox generated Malware Package.				
Archived File	An icon appears if the file is an archived file.				
Rating	Indicates the risk level of the file, such as "High Risk" for potentially harmful files.				
Threat Name	Describes the threat category or malware family the file is associated with.				
Device	Identifies the source device from which the file originated.				
Source	Provides additional details about the file's origin or source information.				
Status	Displays the current state of the incident action, which includes options such as <i>New</i> , <i>In Progress</i> , <i>False Positive</i> , <i>Ignored</i> , <i>Closed</i> , or <i>Reopened</i> .				
Last Update:	Displays the date of the most recent action performed on the file entry.				

Available Actions

For each file entry listed, administrators can perform the following actions:

View Job Detail	Click the icon to open a detailed view of the scanned file, providing more information about the scan results.
Take Action	Click to opens the <i>Incident Actions</i> pane where you can update the status of the job and take further steps, such as marking it as a false positive, or sending a reminder to the administrator.
Perform Rescan	Allows you to re-scan the file. See more details on rescanning under the File Job > Perform Rescan .

Incident Actions Pane

When you click *Take Action*, a pane opens from the right-side of the page where you can manage the incident.

The *Incident Actions* pane contains the following options:

Status	Change the job status to one of the following: <table border="1" data-bbox="560 1690 1458 1801"> <tr> <td>New</td> <td>No action has been taken yet.</td> </tr> <tr> <td>In Progress</td> <td>The file is under review.</td> </tr> </table>	New	No action has been taken yet.	In Progress	The file is under review.
New	No action has been taken yet.				
In Progress	The file is under review.				

False Positive	The file is falsely flagged as suspicious or malicious. If selected, you can mark the file as <i>Clean</i> locally or report it to the FortiGuard team for further analysis. When False Positive is marked from the <i>Job Detail</i> page, the status will change to <i>False Positive</i> . If it is reset to <i>Positive</i> , the Status will change back to <i>New</i> .
Ignored	The file can be ignored without further action.
Closed	The incident is resolved, and no further actions are required.
Reopened	Reopens the incident for further investigation.
Submit Feedback to Cloud	This option is available only when <i>False Positive</i> is selected, allowing you to submit the suspicious file to the FortiGuard team for analysis.
Contact Email	Displays when feedback to the cloud is enabled, where you can input an email for responses.
Comment	<p>Add comments regarding the action taken on the job.</p> <ul style="list-style-type: none"> If <i>False Positive</i> is selected, a comment must be entered. In addition to being recorded in the <i>Action Logs</i>, the comment will also be recorded in <i>Scan Job > Overridden Verdict</i>. If <i>Submit Feedback to Cloud</i> is enabled, the comment will be sent to the FortiGuard team. If any other status is selected, the comment will only be logged in the <i>Action Logs</i> without submitting feedback to FortiGuard.
Copy Incident Information	Copy details of the job incident to the clipboard.
Send Reminder	Allows you to send reminders about the job to designated email addresses. To configure this feature, go to <i>System > Mail Server</i> .

Information and Logs

- The *Incident Actions* pane also provides detailed information and logs for the job. This includes:
 - Incident Time*: The timestamp when the file was flagged.
 - Rating*: The risk level of the file, such as *High Risk* for potentially harmful files.
 - Rated By*: The engine that assessed the file, (for example, *Static Scan Engine*).
 - Suspicious Type*: The category of suspicious behavior or characteristics detected.
 - Infected OS*: The operating system affected by the file.
 - Device*: The source device from which the file originated.
 - Malware*: Describes the threat category or malware family the file is associated with.
 - Source*: Additional details about the file's origin.
 - Destination*: Information about where the file was intended to go.
 - Service*: The service associated with file scanning.
 - Job ID*: A unique identifier for the scanned file job.
 - File Name*: The name of the scanned file.

- *URL*: The link associated with the scanned file.
- *Scan Unit*: The identifier for the scanning unit that processed the file.

Click *More Detail* to redirect to the *Job Detail* page for further information and analysis.

- *Action Logs*: Displays a list of actions taken on the job, including:
 - *User*: The admin or user who performed the action.
 - *Time*: The timestamp when the action was performed.
 - *Feedback to the cloud*: Shows the content the user input in the comment, if feedback was sent to the FortiGuard team.
 - *Commented*: Additional comments made during the action.

Search and Filtering

The *Incident Assist* page allows admins to perform advanced searches to filter and locate specific entries efficiently. The search function includes a filterable columns and pattern matching options to narrow down results.

Filterable Columns

Click the plus symbol  to open the *Filterable Columns* list. The filterable columns include:

Incident Time	Filter entries by selecting a time period, calculated using various methods.
File Name	Allows filtering by exact filename or using a pattern-based search.
Rating	Filters files based on their assigned risk level.
Device	Filters by the device or source adapter that triggered the file scan.
Source	Filters by the origin or metadata associated with the file.
Status	Filters by the file's current status (for example, <i>New</i> , <i>In Progress</i> , <i>Closed</i>).
Last Update	Filters files based on their most recent update.
Destination	Displays where the file was intended to go within the network.
File MD5 and File SHA256	Filters files based on their cryptographic hash values.
General Search	Combines multiple search filters for more detailed search queries.
File Operation, Memory Operation, Network Operation, Registry Operation	Filters based on specific types of operations found within the scan details. These filters apply to jobs rated by the dynamic scan engine.
Infected OS	Filters based on the operating system that scanned the file.
Job ID	Filters based on the unique ID assigned to each file scan job.
Mitre ATT&CK Techniques	Filters files using techniques associated with the MITRE ATT&CK framework. You can search using identifiers like <i>T1204/002</i> to specify

	particular techniques.
Rated By	Filters by rated techniques.
Service	Filters by the service involved in handling the file.

When filtering by *Device*, *Status*, *Infected OS*, *Rated By*, or *Service* fields, suggested values as well as job counts will be displayed.

Search Operations

For specific operations such as *File Operation*, *Memory Operation*, *Network Operation*, or *Registry Operation*, you can input any value related to search within the behavior logs of the file. These options are available only for files rated by the *Dynamic Scan*. In all cases, the respective operation tables can be accessed by opening the *File Job > Job Detail* page, navigating to the *Behavior* tab, and selecting the relevant option.

General Search

A combined filter that allows input values across multiple categories, specifically *File Operation*, *Memory Operation*, *Network Operation*, *Registry Operation*, and *Mitre ATT&CK Techniques*.

Only those jobs rated by the Dynamic scan can be searched using General Search.

Customize the Dashboard

You can customize *Dashboard > Status*. You can select which widgets to display, where they are located on the page, and whether they are minimized or maximized.

To move a widget:

Position your pointer on the widget's title bar, then click and drag the widget to its new location.

To reset a widget back to default settings:

Click the *Reset* button at the top-left of the main page

To add a widget:

1. In the *Status* dashboard, click the *Add widget* button on the top left of the main page.
2. Select the widgets you want to add in the new window.
3. To hide a widget, click the options menu $\equiv \triangleright$ and select *Remove*, then confirm your selection in the pop-up window.

The following is a list of widgets you can add to *Dashboard > Status*.

- [System Information on page 13](#)
- [Connectivity and services widget on page 15](#)
- [Scan Performance \(widget\) on page 24](#)
- [System Resources on page 25](#)
- [Scan Statistics on page 26](#)
- [File Scan on page 27](#)
- [Top Devices on page 27](#)
- [Pending Job Statistics on page 28](#)
- [Top Critical Logs on page 28](#)
- [Sniffer Traffic on page 28](#)
- [Threats Distribution on page 28](#)
- [Quick Download on page 28](#)
- [Runtime Usage on page 28](#)

To edit a widget:

1. Select the edit icon in the widget's title bar to open the edit widget window.
2. Configure the following information, and then select *OK* to apply your changes:

Updating Interval	Enter a refresh interval for the widget, in seconds.
Top Count	Select the number of entries to display in the widget. This option is only available on widgets where a top count is applicable.
Time Period	Select a time period to be displayed from the dropdown list. This option is only available on widgets where a time period is applicable.

Scan Performance (widget)

The *Scan Performance* widget displays scan performance information including the number of files scanned, performance, and the security verdict. The data is accumulated every 10 minutes. You can click the numbers in next to verdict in the *Security* column to drill down to the job list. To view granular information, see the [Scan Performance](#) page.

The Scan Performance widget Security verdict column is updated to displayed following information:

Security	0-Day Files	Calculate all file jobs rated as <i>Low Risk</i> to <i>High Risk</i> .
	0-Day URLs	Calculate all URL jobs rated as <i>Low Risk</i> to <i>High Risk</i> .
	Known Malware Files	Calculate all file jobs rated as <i>Malicious</i> .
	Known Malware URLs	Calculate all URL jobs rated as <i>Malicious</i> .

The date and time of the data calculation is displayed at the bottom of the widget (for example, *Completed Jobs as of Jun-13 09:40*).

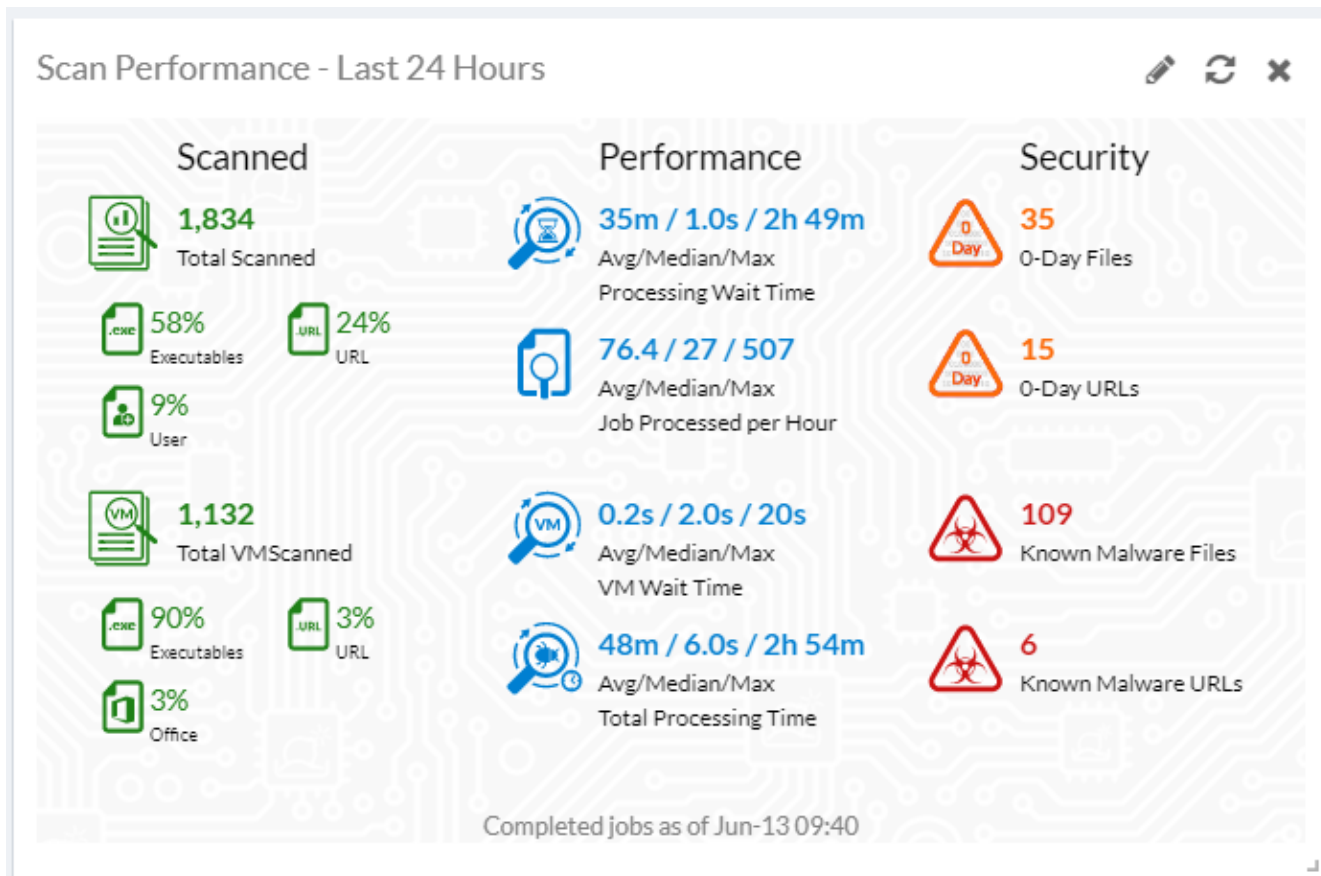

System Resources

This widget displays the following information and options:

CPU Usage	Gauges the CPU percentage usage.
Memory Usage	Gauges the memory percentage usage.
RAID	Displays current model RAID Level and status.
Disk Usage/RAM Disk Usage/ VM Disk Usage	Gauges the disk percentage usage. RAM disk is used by the VM clone system.
Reboot/Shutdown	Options to shut down or reboot the FortiSandbox device.



- All VM models, including 5HF and 5HG models do not support RAID, VM Disk, or RAM Disk.
- The 1KF model does not support VM Disk and RAM Disk.
- The 2KE and 15HG models do not support VM Disk.

Scan Statistics

This widget displays information about the files that have been scanned over a specific time period, including the following information.

Inputs	The input type from which the files were received.
Device, Adapter, On Demand, Network Share, Sniffer, URL, All Sources	The URL type is for scanned URLs received from FortiMail devices, URLs extracted from forwarded email body of BCC adapter, URLs from ICAP adapter, and sniffed URLs in email traffic.
Pending	The number of files pending. Pending files are files that have just been received and have not been put into the job queue, and files that have been put into the job queue but have not yet been processed.
Processing	The number of files that are being processed.
Malicious	The number of files scanned for each input type that were found to be malicious in the selected time period. Click the number to view the associated jobs.
High Risk	The number of files scanned for each input type that were found to be suspicious and posed a high risk in the selected time period. Click the number to view the associated jobs.
Medium Risk	The number of files scanned for each input type that were found to be suspicious and posed a medium risk in the selected time period. Click the link to view the associated jobs.
Low Risk	The number of files scanned for each input type that were found to be suspicious and posed a low risk in the selected time period. Click the number to view the associated jobs.
Clean	The number of files scanned for each input type that were found to be clean in the selected time period. Click the number to view the associated jobs.
Other	The number of files for each input type which have an unknown status. Unknown status files include jobs which have timed out, crashed, canceled by the user through a JSON API call, or terminated by the system. Click the number to view the associated jobs.
Total	The total number of files for each input type in the selected time period.



If the device is the primary node of a cluster, the numbers in this widget are the total job numbers of all cluster nodes.

You can enable/disable the *Include Historical Stats* option in the settings of the *Scan Statistics* widget.

- When enabled, the widget shows statistics for jobs that were finished within the specified time period.
- When disabled, the widget only shows statistics for jobs that are not cleaned up.

This button only appears when *Maintain statistical records of jobs* is checked in *System > Settings*.

How admin permissions apply to scan statistics

An admin's permissions in the *Menu Access* section of the admin profile determines which jobs the admin can see in the *Scan Statistics* widget. See [Admin Profiles on page 156](#).

Admin Profile	Permissions
Super Admin	The widget shows the number of jobs scanned including a hyperlink. When the admin clicks the hyperlink, they are redirected to a new page listing all the jobs.
Read Write	The widget shows the number of jobs scanned including a hyperlink. When the admin clicks the hyperlink, the new page will only show jobs which are submitted on-demand by the admin, and all other input jobs, such as <i>Sniffer</i> .
Read Only	The widget shows all job numbers. However, the hyperlink is disabled.

File Scan

This widget shows the number of clean, suspicious, and malicious events that have occurred at specific times over a selected time period.

The data can be displayed hourly or in daily. If it is set to *Hourly*, a bar displays each hour over the time period. Hourly data is only available when the time period is set to the *Last 24 hours*. If it is set to *Daily*, a bar shows each day over the time period.

Shift-select a period to zoom in. Shift-scroll to move left and right.

Hover the pointer over a colored portion of a bar in the graph to see the number of events of that type for that time period.

Top Devices

This widget displays the total number of scanning jobs for the top five devices over a selected time interval.

Hover the pointer over a bar in the graph to see the number of scanning jobs for that device.

Pending Job Statistics

This widget displays the pending job numbers of each input source.

Hover the pointer over the graph displays the number of pending jobs for the on-demand, sniffer, and Fortinet devices over a selected time period. Shift-select a period to zoom in. Shift-scroll to move left and right.



If the FortiSandbox does not reboot, data is updated every 10 minutes. If the FortiSandbox reboots, wait for 25 minutes plus the next data collection time, resulting in a maximum wait of 35 minutes to receive the new data.

Top Critical Logs

This widget displays recent critical logs, including the time they occurred and a brief description of the event.

Sniffer Traffic

This widget displays the Sniffer Traffic Throughput in MB/s over a selected time period.

Shift-select a period to zoom in. Shift-scroll to move left and right.

Threats Distribution

This widget displays a chart of the detected malware rating distribution for two specified time periods. Hover the pointer over parts of the chart to see more details.

Quick Download

This widget works with the CDR feature in FortiGate or FortiMail. You can quickly find a file according to its checksum (SHA256/SHA1/MD5). If found, you can download the original file, download the jobs PDF report, and view job details. The original file is in zip format and protected with the password *fortisandbox*.

Runtime Usage

This widget displays a timeline of CPU, memory, and RAM disk usage over a specified time period.

Hover the pointer over the graph for more details. Shift-select a period to zoom in. Shift-scroll to move left and right.

Administrative task alert notifications

The alert notification feature reminds administrators of tasks requiring actions. This feature appears as a bell icon on the top-right corner of the GUI. On a HA cluster deployment, this alert only appears and requires action on the primary node. The types of reminders listed below:

- *Expired or expiring Password*: The Notifications icon in FortiSandbox will alert administrators that a password will expire seven days before the expiration date.
- *Detected suspicious or malware*: The system keeps track of any files/URLs rated as suspicious or malware in the *Incident Assist* page. Admins or Security Operation Center (SOC) teams can monitor that GUI page, review the detailed reports and take appropriate actions. To enable or disable this feature, go to *System > Settings* and toggle the option *Show Alarms for Unprocessed Detections*.
- *Scan Profile requiring configuration action*: This alert reminder indicates that the Scan Profile requires your configuration changes. When clicked, the alert redirects administrators to the *Scan Profile > VM Association* page.

Scan mode

FortiSandbox supports two scan modes: Full mode and Lite mode. The default is full mode. Use the `lite-mode` CLI command to switch the scan mode. For more information about Lite mode, see [Appendix G: FortiSandbox Lite Mode on page 263](#).

- **Full Mode**: Includes both static and dynamic scanning, a full set of deployment and integrations, and fully customizable policies.
- **Lite Mode**: Includes the static scanning, essential Security Fabric integrations and NetShare, and only Pre-Filter policy configuration.

When Lite Mode is enabled, the banner at the top of the GUI displays a *Lite Mode* label. For HA Cluster deployment, only the Primary node can be configured to switch the Scan mode. This setting will be automatically synchronized to all nodes in the cluster.

The following table compares the available features in Full and Lite Mode:

Module	Option	Full Mode	Lite Mode
Scanning Functions			
	Pre Scan	✓	✓
	AV Scan	✓	✓
	Static Scan	✓	✓
	Dynamic Scan	✓	X
Security Fabric Sources			
	Device (e.g. FortiGate, FortiMail, FortiProxy)	✓	✓

Module	Option	Full Mode	Lite Mode
	FortiClient	✓	✓
	FortiNDR	✓	X
	Network Share	✓	✓
	Adapter	✓	X
	Quarantine	✓	X
	Sniffer	✓	X
VM Settings			
	VM Installation	✓	X
	Guest VM Usage and Configuration	✓	X
Scan Policy			
	Allowlist / Blocklist	✓	✓
	Web Category	✓	X
	Customized Rating	✓	X
	Yara Rules	✓	✓
	Job Priority	✓	X

Security Fabric

FortiSandbox utilizes Fortinet antivirus to scan files for known threats and then executes files in a VM host environment. Unlike traditional sandboxing solutions, FortiSandbox is able to perform advanced static scans, which can quickly and accurately filter files, and utilize up-to-the-minute threat intelligence of FortiGuard services.

There are five methods to import files to your FortiSandbox: sniffer mode, device mode (including FortiGate, FortiMail, FortiWeb, and FortiClient endpoints), adapter, network share, and on demand (including on demand through JSON API call and GUI submission). In sniffer mode, the FortiSandbox sniffs traffic on specified interfaces, reassembles files, and analyzes them. In device mode, your FortiGate, FortiWeb, FortiMail, or FortiClient endpoints are configured to send files to your FortiSandbox for analysis, and can receive malware packages from the FortiSandbox. Network share allows you to scan files located on a remote file share as scheduled, and quarantine bad files. On demand allows you to upload files, URLs inside a file, or archived files directly to your FortiSandbox for analysis. Different adapters allow FortiSandbox to work with third-party products smoothly.

FortiSandbox will execute code in a contained virtual environment by simulating human behavior and the output is analyzed to determine the characteristics of the file. Inspection is run post-execution and all aspects of the file are examined. FortiSandbox checks files for the dozens of suspicious characteristics, including but not limited to:

- Evasion techniques
- Known virus downloads
- Registry modifications
- Outbound connections to malicious IP addresses
- Infection of processes
- File system modifications
- Suspicious network traffic

FortiSandbox can process multiple files simultaneously since it has a VM pool to dispatch files to for sandboxing. The time to process a file depends on the hardware and the number of sandbox VMs used to scan the file. It can take from 60 seconds to five minutes to process a file.

Device

In Device mode, you can configure your FortiGate, FortiWeb, FortiClient, FortiMail, FortiProxy, and FortiADC devices to send files to FortiSandbox. For FortiGate, you can send all files for inspection. For FortiMail, you can send email attachments or URLs in the email body to FortiSandbox for inspection, or just send the suspicious ones. When FortiSandbox receives the files or URLs, they are executed and scanned within the VM modules. FortiSandbox sends statistics back to the FortiGate, FortiWeb, and FortiMail. When integrated with FortiGate, supported protocols include: HTTP, FTP, POP3, IMAP, SMTP, MAPI, IM, and their equivalent SSL encrypted versions.



Each client device can have multiple concurrent connections to FortiSandbox at one time. These connections are used for file transfers and result queries. The maximum number of concurrent connections is 20,000 for FSA 3000E, 3000F and 3000G models, and 10,000 for all other models. When this limit is exceeded, new connections will be rejected, and an event log will be generated.

Use the *Security Fabric > Device* page to view, edit, and authorize devices.

Devices such as FortiGate can query a file's verdict and retrieve detailed information from FortiSandbox. FortiGate can also download malware and URL packages from FortiSandbox as complementary AV signatures and web filtering blocklists. These packages contain detected malware signatures and their downloading URLs.

The default file size scanned and forwarded by FortiGate is 10MB and the maximum size depends on the FortiGate memory size. To change the file size on the FortiGate side, use the following CLI commands:

```
config firewall profile-protocol-options
  edit <name_str>
    config http
      set oversize-limit <size_int>
    end
  end
```

The `profile-protocol-options` setting controls the maximum file size that is AV scanned on the FortiGate. After a virus scan verdict has been made (clean or suspicious), if the file size is less than the `analytics-max-upload` size, it is sent to FortiSandbox using the *Send All/Suspicious Only* setting on the FortiGate.

For information on configuring the oversize limit for `profile-protocol-options` and `analytics-max-upload`, see the FortiOS CLI Reference in the [Fortinet Document Library](#).

In *Security Fabric > Device*, the following options are available:

Refresh	Refresh display after applying search filters.
Device Filter	Filter devices by entering part of device name, serial number or authorization status.
Clear all removable filters	Click the trash can icon to remove all filters.

This page displays the following:

Device Name	Name of the device and the VDOM or protected email domain that send files to FortiSandbox. For a device, it has the format of: <i>Device Name</i> . For a VDOM, it has the format of: <i>Device Name: VDOM Name</i> . For a FortiMail protected domain, it has the format: <i>Device Name : Domain Name</i> .
Serial	The FortiGate, FortiWeb, FortiClient, FortiClient EMS, or FortiMail serial number.
Malicious, High, Medium, Low	The number of malicious, high risk, medium risk, or low risk files submitted by the device to FortiSandbox in the last seven days. FortiClient EMS displays the number of files submitted to FortiSandbox by FortiClient endpoints that are managed by EMS.
Clean	Number of clean files submitted by the device to FortiSandbox in the last seven days. FortiClient EMS displays the number of clean files submitted to FortiSandbox by FortiClient endpoints that are managed by EMS.

Others	Number of other files submitted by the device to FortiSandbox in the last seven days. FortiClient EMS displays the number of other rating files submitted to FortiSandbox by FortiClient endpoints that are managed by EMS.
Mal Pkg	Malware package version currently on the device.
URL Pkg	URL package versions currently on the device.
Auth	Shows if the device or VDOM/Protected Domain is authorized to submit files. Only authorized device or VDOM/Protected Domain can submit files to FortiSandbox.
Limit	Shows if this device has a submission limit.
Inline Block	Shows the FortiGate or its VDOM inline block status.
Last Seen	Shows the device last seen date and time.
Status	Status of the device. An icon shows that the device is up or connected, down, or disconnected. If a device, its VDOM, or protected domain does not contact FortiSandbox for more than 15 minutes, the status changes to disconnected.
Delete	Click to delete the device, VDOM, or protect domain. When you delete a device, all its VDOMs and protected domains are also deleted. If the device is FortiClient EMS, its managed FortiClient endpoints are kept. If the device connects to FortiSandbox again, it appears as a new device. To delete multiple devices, hold down the <i>Ctrl</i> or <i>Shift</i> key, select the devices you want to delete, and then click the <i>Delete</i> button located in the top-left corner.



FortiSandbox uses a Fortinet proprietary traffic protocol (based on OFTP) to communicate with connected Security Fabric devices via TCP port 514. The traffic data is encrypted over TLS.

Supported Devices

FortiSandbox supports the following devices:

FortiGate/FortiProxy	<p>FortiSandbox can perform additional analysis on files that have been AV scanned by FortiGate. You can configure FortiGate to send all files or only suspicious files passing through the AV scan.</p> <p>FortiGate can retrieve scan results and details from FortiSandbox, and also receive antivirus and web filtering signatures to supplement the current signature database.</p> <p>When FortiGate learns from FortiSandbox that a terminal is infected, the administrator can push instruction for self-quarantine on a registered FortiClient host.</p>
FortiMail	<p>You can configure FortiMail to send suspicious, high risk files and suspicious attachments to FortiSandbox. FortiSandbox can perform additional analysis on files that have been scanned by your FortiMail email gateway.</p> <p>Suspicious email attachments include:</p>

- Suspicious files detected by heuristic scan of the AV engine.
- Executable files and executable files embedded in archive files.
- Type 6 hashes (binary hashes) of spam email detected by FortiGuard AntiSpam service.

FortiMail can send suspicious URLs in the email body to FortiSandbox for URL scans and then block suspicious emails based on the scan result.

FortiWeb

You can use a file upload restriction policy to submit uploaded files to FortiSandbox for evaluation. If FortiSandbox determines that the file is malicious, FortiWeb performs the following tasks:

- Generate an attack log message that contains the result, for example, messages with the Alert action.
- For 10 minutes after it receives the FortiSandbox results, take the action specified by the file upload restriction policy. During this time, it does not re-submit the file to FortiSandbox, for example, messages with the Alert_Deny action.

FortiClient EMS

You can configure a FortiSandbox IP address in an endpoint profile. FortiClient EMS attempts to submit an authorization request to FortiSandbox. FortiSandbox administrators can authorize it and set limitations about submission speed. Subsequently, all FortiClient endpoints managed by FortiClient EMS are considered authorized by the same FortiSandbox and follow the submission speed limit.

FortiClient

FortiSandbox can accept files from FortiClient to perform additional analysis while FortiClient holds the files until the scan results are received. FortiClient can also receive additional antivirus signatures from FortiSandbox, generated from scan results, to supplement current signatures.

FortiGate devices

You can add FortiSandbox as a Security Fabric device in FortiGate. For information on how to configure FortiGate to send files to FortiSandbox, see the FortiGate guides in the [Fortinet Document Library](#).

On FortiSandbox, go to *Security Fabric > Device* to see the FortiGate devices and VDOMs.

The communication protocol does not include a way for the FortiGate to notify FortiSandbox whether VDOMs are enabled. When VDOMs are disabled on the FortiGate, the files from FortiGate are marked with *vdom=root*.



Since the FortiGate does not explicitly send a list of possible VDOMs to FortiSandbox, FortiSandbox only knows about a VDOM after it receives a file associated with it. Each of the devices VDOMs listed on this page are displayed after the first file is received from that specific VDOM.

If VDOMs are enabled on FortiGate, you can select the checkbox to have new VDOMs inherit authorization based on the device level setting. If the FortiGate authorization is disabled, all VDOMs under it will not be authorized even if authorization is enabled for a VDOM.

To edit FortiGate settings in FortiSandbox:

1. On your FortiSandbox device, go to *Security Fabric > Device*.
This page lists all devices and VDOMs.
2. Click the FortiGate device name to open the *Edit Device Settings* page.
3. Edit the following settings and then click *OK*.

Device Status	
Serial Number	Device serial number.
Hostname	FortiGate host name.
IP	IP address of the FortiGate.
Status	Status of the device.
Last Modified	Date and time the FortiGate settings were last changed.
Last Seen	Date and time the FortiGate last connected to FortiSandbox.
Permissions & Policy	
Authorized	Enable to authorize the FortiGate device. If disabled, files sent from FortiGate are dropped.
New VDOMs/Domains Inherit Authorization	Enable to have new VDOMs inherit the authorization setting configured at the device level.
Email Settings	
Administrator Email	Email address in <i>Notifier email</i> in FortiGate at <i>Security Fabric > Settings > Sandbox Inspection</i> .
Send Notifications	<p>Enable to send notifications. When enabled, you receive email notifications when a file from your environment is detected as potential malware. The email contains a link to the scan job details page.</p> <p>To receive notification emails, configure a mail server in <i>System > Mail Server</i> and enable <i>Send a notification email to the Device/Domain/VDOM email list when Files/URLs with selected rating are detected</i>. Otherwise, a warning icon displays.</p>
Send PDF Reports	<p>Enable to send PDF reports of job details.</p> <p>To receive reports and define report generation frequency, configure a mail server in <i>System > Mail Server</i> and enable <i>Send scheduled PDF report to Device/Domain/VDOM email address</i>. Otherwise, a warning icon displays.</p>
Inline Block Policy	<p>Enable to check for a trusted verdict for FortiGate.</p> <ul style="list-style-type: none"> • If Yes, the verdict is returned and the file is dropped and a log is created. • If No, the file is added to the job queue. <p>Select the risk level to be blocked: <i>Malicious, High Risk, Medium Risk</i> or <i>Low Risk</i>.</p>

To edit VDOM settings:

1. On your FortiSandbox device, go to *Security Fabric > Device*. This page lists all devices and VDOMs.
2. Click the VDOM name to open the *Edit Domain Settings* page.
3. Edit the following settings and then click *OK*.

Device Status	
Domain/VDOM	Device VDOM name.
Serial Number	Device serial number.
Hostname	VDOM name in the format of Device-Name:VDOM-name.
IP	IP address of the FortiGate.
Status	Status of the device.
Files Transmitted	Number of files and URLs transmitted to FortiSandbox in the last seven days.
Last Modified	Date and time the authorization status was changed.
Last Seen	Date and time the FortiGate VDOM last connected to FortiSandbox.
Permissions & Policy	
Authorized	Enable to authorize the FortiGate VDOM.
Submission Limitation	Limit the VDOM submission speed. Select <i>Unlimited</i> or specify the number of submissions per <i>Hour</i> or <i>Day</i> . When the limit is reached, FortiSandbox sends a signal to FortiGate to stop file submission to save resources on both devices.
Email Settings	
Email	Enter the administrator email addresses for the VDOM, separated by commas.
Send Notifications	Enable to send notifications when viruses or malware from this VDOM is detected. To receive notification emails, configure a mail server in <i>System > Mail Server</i> and enable <i>Send a notification email to the Device/Domain/VDOM email list when Files/URLs with selected rating are detected</i> . Otherwise, a warning icon displays.
Send PDF Reports	Enable to send PDF reports of job details. To receive reports and define report generation frequency, configure a mail server in <i>System > Mail Server</i> and enable <i>Send scheduled PDF report to Device/Domain/VDOM email address</i> . Otherwise, a warning icon displays.
Send Reach Limit Alert Email	Enable to send an alert email to the VDOM email address when <i>Submission Limitation</i> is reached.

Inline Block Policy

The *Inline Block Policy* improves the scan performance by checking for a trusted verdict and return to FortiGates running FOS v7.2 and higher.

- If a trusted verdict is found, the verdict is returned, the file is released, and a log is created.
- If a trusted verdict is not found, the file is added to the job queue and action is taken based on the policy configuration.

You can select the file types FortiGate is allowed to send to FortiSandbox. All other file types will be blocked.

For information about Inline Block, see [Understanding the Inline Block feature](#) in the *Best Practices and Troubleshooting Guide*.

To enable Inline Block Policy:

1. Go to *Security Fabric > Device* and select a FortiGate device.
2. Enable *Inline Block Policy*. The default file list is displayed.
3. Under *Files with selected risk will be blocked*, select the risk level (*Malicious, High Risk, Medium Risk* or *Low Risk*). You can select multiple risk levels.
4. (Optional) Add additional file types.
 - a. Click *Add inline block files types*. The available file types are displayed.
 - b. Select the files to be added to the inline block list or click *Select a/l*.
 - c. To remove files from the block list, click *Restore to default types*.
5. Click *OK*.



FortiSandbox must be reachable via port 4443.

To automatically enable Inline Block policy on all FortiGates:

```
device-authorization -i
```



The FortiGate needs to be authorized manually in the *Security Fabric > Device* page before FortiSandbox can accept files from it. FortiGate can only connect to FortiSandbox by an Admin or API port for Inline Blocking.

FortiMail Devices

You can configure FortiMail to send suspicious files, URLs, and suspicious attachments to FortiSandbox for inspection and analysis. FortiSandbox statistics for total detected and total clean are displayed in FortiMail.

If FortiMail sends protected domain information, the domain names and jobs counts from them are listed. For each protected domain, you can set a submission limitation. If protected domain information is not available, such as files from older versions of FortiMail or outgoing emails, jobs from them are grouped in the Unprotected domain name.

For information on how to configure FortiMail to send files to FortiSandbox, see the *FortiMail Administration Guide* in the [Fortinet Document Library](#).

To edit FortiMail Settings in FortiSandbox:

1. On your FortiSandbox device, go to *Security Fabric > Device*.
This page lists all devices and protected domains. Since FortiMail does not explicitly send a list of possible protected domains to FortiSandbox, FortiSandbox only knows about a domain after it receives a file or URL. Domains on this page are displayed after the first file or URL is received on that domain.
2. Click the FortiMail device name to open the *Edit Device Settings* page.
3. Edit the following settings and then click *OK*.

Device Status	
Serial Number	Device serial number.
Hostname	FortiMail host name.
IP	IP address of the FortiMail.
Status	Status of the device.
Last Modified	Date and time the FortiMail settings were last changed.
Last Seen	Date and time the FortiMail last connected to FortiSandbox.
Permissions & Policy	
Authorized	Enable to authorize the FortiMail device. If disabled, files sent from FortiMail are dropped.
New VDOMs/Domains Inherit Authorization	Enable to have new protected domains inherit the authorization setting configured at the device level.
Email Settings	
Administrator Email	Email address in <i>Notifier email</i> in FortiMail.
Send Notifications	<p>Enable to send notifications. When enabled, you receive email notifications when a file inside an email is detected as potential malware. The email contains a link to the scan job details page.</p> <p>To receive notification emails, configure a mail server in <i>System > Mail Server</i> and enable <i>Send a notification email to the Device/Domain/Vdom email list when Files/URLs with selected rating are detected</i>. Otherwise, a warning icon is displays.</p>
Send PDF Reports	<p>Enable to send PDF reports of job detail.</p> <p>To receive reports and define report generation frequency, configure a mail server in <i>System > Mail Server</i> and enable <i>Send scheduled PDF report about an individual VDOM/Domain to its email address</i>. Otherwise, a warning icon is displays.</p>

To edit Domain settings:

1. On your FortiSandbox device, go to *Security Fabric > Device*.
2. Click the domain name.
3. Edit the following settings and then click *OK*.

Device Status	
Domain/VDOM FQDN	Protected domain name.
Hostname	Domain/VDOM name in the format of FortiMail Device Name: Domain name.
IP	IP address of the FortiMail.
Status	Status of the device.
Files/URLs Transmitted	Number of files and URLs sent to the domain in the last seven days.
Last Modified	Date and time the authorization status was changed.
Last Seen	Date and time last file/URL was sent to this domain.
Permissions & Policy	
Authorized	Enable to authorize the FortiMail domain.
Submission Limitation	Limit the protected domain submission speed. Select <i>Unlimited</i> or specify the number of submissions per <i>Hour</i> or <i>Day</i> . When the limit is reached, FortiSandbox rejects files and URLs sent to this domain.
Email Settings	
Email	Enter the administrator email addresses for the domain, separated by commas.
Send Notifications	Enable to send notifications when viruses or malware to this domain is detected. To receive notification emails, configure a mail server in <i>System > Mail Server</i> and enable <i>Send a notification email to the Device/Domain/VDOM email list when Files/URLs with selected rating are detected</i> . Otherwise, a warning icon is displays.
Send PDF Reports	Enable to send PDF reports of jobs. To receive reports and define report generation frequency, configure a mail server in <i>System > Mail Server</i> and enable <i>Send scheduled PDF report about an individual VDOM/Domain to its email address</i> . Otherwise, a warning icon is displays.
Send Reach Limit Alert Email	Enable to send an alert email to the domain email address when <i>Submission Limitation</i> is reached.

To upload file attachments on emails:

For information on how to configure FortiMail to send files to FortiSandbox, see the *FortiMail Administration Guide* in [Fortinet Document Library](#).

Device and VDOM/Domain level notifications

If you enable *Send notifications* in the *Edit Device Settings* or *Edit VDOM/Domain Settings* page, you receive an email every time a file from your environment is detected as potential malware.

Device and VDOM/Domain level PDF reports

If you enable *Send PDF reports* in *Edit Device Settings* or *Edit VDOM/Domain Settings*, you receive a PDF report by email as defined in *System > Mail Server*. This FortiSandbox Summary Reports PDF lists statistics of scan jobs in the time period in *System > Mail Server* and includes the following information:

- Scan Statistics: The number of files processed by FortiSandbox and a breakdown of files by rating.
- Scan Statistics by Type: The file type, rating, and event count.
- Scanning Activity: A table and graph listing the number of clean, suspicious, and malicious files processed by FortiSandbox per day.
- Top Targeted Hosts: The top targeted hosts.
- Top Malware Files: The top malware programs detected by FortiSandbox.
- Top Infectious URLs: The top infectious URLs detected by FortiSandbox.
- Top Callback Domains: The top callback domains detected by FortiSandbox.

FortiWeb Devices

For information on how to configure FortiWeb to send files to FortiSandbox, see the [FortiWeb Administration Guide](#) in the Fortinet Document Library.

FortiProxy Devices

For information on how to configure FortiProxy to send files to FortiSandbox, see the [FortiProxy Administration Guide](#) in the Fortinet Document Library.

Inline Block Policy

The *Inline Block Policy* improves the scan performance by checking for a trusted verdict and return to FortiProxy running FortiProxy v7.4.3 and higher.

If a trusted verdict is:

- Found: The verdict is returned, the file is released, and a log is created.
- Not found: The file is added to the job queue and action is taken based on the policy configuration.

You can select the file types FortiProxy is allowed to send to FortiSandbox. All other file types will be blocked. For information about Inline Block, see [Understanding the Inline Block feature](#) in the FortiSandbox Best Practices Guide.

FortiClient EMS Devices

For information on how to configure FortiClient EMS to send files to FortiSandbox, see the *FortiClient EMS Administration Guide* in the [Fortinet Document Library](#).

To edit EMS settings in FortiSandbox:

1. On your FortiSandbox device, go to *Security Fabric > Device*.
2. Click the device name to open the *Edit Device Settings* page.
3. Edit the following and then click *OK*.

Device Status	
Serial Number	Device serial number.
Hostname	EMS host name.
IP	IP address of the EMS.
Status	Status of the device.
Last Modified	Date and time the EMS settings were last changed.
Last Seen	Date and time the EMS last connected to FortiSandbox.
Permissions & Policy	
Authorized	Enable to authorize the EMS device. All FortiClient endpoints managed by EMS inherit this authorization setting.
Submission Limitation	Limit the submission speed of FortiClient endpoints managed by EMS. Select <i>Unlimited</i> or specify the number of submissions per <i>Hour</i> or <i>Day</i> . When the limit is reached, FortiSandbox sends a signal to FortiClient to stop file submission to save resources on both devices.

FortiClient

FortiClient 5.4 and earlier versions can silently connect to FortiSandbox without the need to be authorized. You can de-authorize a FortiClient host manually. If a FortiClient endpoint is managed by EMS, it follows the authorization status and file submission speed setting of EMS. You can manually change these settings.

For information on how to configure FortiClient to send files to FortiSandbox, see the *FortiClient Administration Guide* in the [Fortinet Document Library](#).

To view connected FortiClient endpoints in FortiSandbox, go to *Security Fabric > FortiClient*.

The following options are available:

Refresh	Refresh display after applying search filters.
Device Filter	Filter devices by serial number, host name, authorization status, IP or EMS.
Clear all removable filters	Click the trash can icon to remove all filters.

This page displays the following:

FCT Serial	The FortiClient serial number.
Hostname	FortiClient host name.
User	Current user logged into the FortiClient host, if available.
IP	Host IP Address.
Malicious, High, Medium, Low	The number of malicious, high risk, medium risk, or low risk files submitted by FortiClient to FortiSandbox in the last seven days. Malicious files are not executed in the FortiSandbox VM module as the antivirus scanner has already determined the file rating.
Clean	Number of clean files submitted by the device to FortiSandbox in the last seven days.
Others	Number of other files submitted by the device to FortiSandbox in the last seven days.
Mal Pkg	Malware package version currently on the device.
Auth	If the FortiClient is authorized, you can click the FortiClient serial number and modify its authorization status.
Limit	Shows if this device has a submission limit.
Status	Status of the FortiClient host. An icon shows that the device is connected (up) or down.
Last Seen	Date and time that FortiClient last connected to FortiSandbox.
Delete	Click to delete the FortiClient. If the device connects to FortiSandbox again, it appears as a new device. To delete multiple devices, hold down the <i>Ctrl</i> or <i>Shift</i> key, select the devices you want to delete, and then click the <i>Delete</i> button located in the top-left corner.

To edit FortiClient settings in FortiSandbox:

1. On your FortiSandbox device, go to *Security Fabric > FortiClient*.
2. Click the device name to open the *Edit FortiClient Settings* page.
3. Edit the following settings and then click *OK*.

FortiClient Status	
Serial Number	Device serial number.
Hostname	FortiClient host name.
IP	IP address of the FortiClient.
Status	Status of the device.
Files Transmitted	Number of files transmitted to FortiSandbox in the last seven days.
Last Seen	Date and time that FortiClient last connected to FortiSandbox.
Permissions & Policy	
Authorized	Enable to authorize the device.

Submission Limitation Limit the submission speed. Select *Unlimited* or specify the number of submissions per *Hour* or *Day*.
When the limit is reached, FortiSandbox sends a signal to FortiClient to stop file submission to save resources on both devices.

Adapter

FortiSandbox uses adapters to integrate with third-party products such as ICAP and mail gateway clients.

With ICAP adapter, FortiSandbox can receive HTTP messages from an ICAP client and return a response.

Mail adapters allow FortiSandbox to receive forwarded emails from an upstream email gateway for scanning. FortiSandbox extracts email attachments and URLs from the email body and adds them to the job queue.

The *MTA adapter* is used to inspect and quarantine suspicious emails. For more details, see [MTA adapter on page 52](#).

The *BCC adapter* is for informational purposes only and does not block emails.

FortiSandbox includes ICAP, BCC, and MTA adapters, which cannot be deleted. These adapters are disabled by default.

This *Adapter* page provides the following information:

Adapter Name	The name of the adapter.
Malicious	The count of files and URLs rated as Malicious from this adapter in the last seven days.
High	The count of files and URLs rated as High Risk from this adapter in the last seven days.
Medium	The count of files and URLs rated as Medium Risk from this adapter in the last seven days.
Low	The count of files and URLs rated as Low Risk from this adapter in the last seven days.
Clean	The count of files and URLs rated as Clean from this adapter in the last seven days.
Other	The count of files and URLs from this adapter that were not rated as Malicious, High, Medium, Low, or Clean in the last seven days.

To edit an adapter:

1. Go to *Security Fabric > Adapter*.
2. Click the *Edit* button from the toolbar.
3. Configure the adapter and click *OK*.

To troubleshoot communication problems with an adapter, use this CLI command:

```
diagnose-debug [adapter_icap | adapter_bcc | adapter_mta_relay | adapter_mta_list]
```

ICAP adapter

FortiSandbox can work as an ICAP server with proxy secure gateway devices (ProxySG) that supports ICAP. The ProxySG will serve as an ICAP client to FortiSandbox. The ICAP client waits (i.e. holds the URL) for the verdict from the FortiSandbox.

To configure an ICAP adapter, first use the CLI to configure the client, and then use the FortiSandbox GUI to configure the server.

Request and response



The ICAP server supports the following methods: POST, GET and PUT.
The ICAP server supports the following formats: *multipart/form-data* and *application/**



If no verdict is available, the URL or files will be placed into the Job Queue for scanning. The URL/file scan flow will be applied.
For example, if a user submits a file containing a phishing URL, Quick Scan may return a CLEAN result since Quick Scan does not check embedded URLs. Subsequently, the file will be submitted to the Job Queue for a full scan. As a result, the final rating may differ from the CLEAN rating obtained in the Quick Scan.

When an ICAP client sends an HTTP request to FortiSandbox, it extracts the URL and checks if a verdict is available.

Status Code	Meaning
200	<ul style="list-style-type: none"> Verdict is not a <i>user selected blocking rating</i> or is not available.
403	<ul style="list-style-type: none"> Verdict is <i>user selected blocking rating</i>. If <i>Quick Scan</i> is enabled, the URL will be scanned in real time by <i>Web Filter</i>.

When an ICAP client sends an HTTP response to FortiSandbox, it extracts the file from it and checks if verdicts are available.

Status Code	Meaning
200	<ul style="list-style-type: none"> Verdict is not a <i>user selected blocking rating</i> or is not available.
403	<ul style="list-style-type: none"> Verdict is <i>user selected blocking rating</i>. If <i>Quick Scan</i> is enabled, the file will be scanned by the defined scan type(s) (<i>AV Scan, Static Analysis, or Cloud Query</i>).

When the ICAP server does not modify the content:

Status Code	Meaning
204	<ul style="list-style-type: none"> No modifications needed

To configure ICAP client:

The following configuration is for a SQUID 4.x to reach the FortiSandbox. You should add this configuration to the end of the `squid.conf` file.

```
cache deny all
icap_enable on
icap_send_client_ip on
icap_send_client_username on
icap_client_username_header X-Authenticated-User
icap_preview_enable off
icap_persistent_connections off
icap_service svcBlocker1 reqmod_precache icap://fortisandbox_ip:port_number/reqmod bypass=0 ipv6=off
adaptation_access svcBlocker1 allow all
icap_service svcLogger1 respmod_precache icap://fortisandbox_ip:port_number/respmod routing=on
    ipv6=off
adaptation_access svcLogger1 allow all
### add the following lines to support ssl ###
#icap_service svcBlocker2 reqmod_precache icaps://sandbox_ip:ssl_port_number/reqmod bypass=1 tls-
    flags=DONT_VERIFY_PEER
#adaptation_access svcBlocker2 allow all
#icap_service svcLogger2 respmod_precache icaps://sandbox_ip:ssl_port_number/respmod bypass=1 tls-
    flags=DONT_VERIFY_PEER
#adaptation_access svcLogger2 allow all
```

The following are examples of how to use ICAPS client certificate authentication:

```
icap_service svcBlocker2 reqmod_precache icaps://sandbox_ip:ssl_port_number/reqmod bypass=0 tls-
cafile=/usr/local/squid/etc/ssl_cert/ca-chain2.cert.pem tls-cert=/usr/local/squid/etc/ssl_
cert/client218.cert.pem tls-key=/usr/local/squid/etc/ssl_cert/client218.key.pem tls-flags=DONT_
VERIFY_PEER,DONT_VERIFY_DOMAIN
```

```
icap_service svcLogger2 respmod_precache icaps://sandbox_ip:ssl_port_number/respmod bypass=0 tls-
cafile=/usr/local/squid/etc/ssl_cert/ca-chain2.cert.pem tls-cert=/usr/local/squid/etc/ssl_
cert/client218.cert.pem tls-key=/usr/local/squid/etc/ssl_cert/client218.key.pem tls-flags=DONT_
VERIFY_PEER,DONT_VERIFY_DOMAIN
```

To configure FortiSandbox as an ICAP server:

1. Go to *Security Fabric > Adapter*.
2. Select the *ICAP* adapter and click *Edit*.
3. *Enable* the ICAP adapter.
4. Under *Connection*, configure the following settings, and then click *Apply*.

Port	The port the ICAP server listens on. Default is 1344.
Interface	The interface the ICAP server listens on. For a cluster, we recommend specifying the interface corresponding to the cluster IP interface (for example, <i>port1 HA</i>).
SSL support	<i>Enable</i> to allow SSL traffic.
SSL port	The port the ICAP server listens on for SSL traffic. Default is 11344.

Certificate	Select server certificate for ICAPS server from the drop-down list. To import certificates and keys go to <i>System > Certificates</i> , and click <i>Import</i> button. You can select a blank from certificate drop-down.
Service name for REQMOD service	Configure a custom service name for the REQMOD service. If the field is empty, the default value <i>reqmod</i> is used.
Service name for RESPMOD service	Configure a custom service name for the RESPMOD service. If the field is empty, the default value <i>respmo</i> is used.
Return code 202 for a new file	This response code is used when the server has accepted a file request but has not completed the processing. The <i>202</i> code added to the standard response code differentiates this case from the case where the file already has a clean verdict.
Return code 202 for a new URL	This response code is used when the server has accepted a URL request but has not completed the processing yet. The <i>202</i> code added to the standard response code differentiates this case from the case where the URL already has a clean verdict.

ICAP profiles

FortiSandbox supports multiple ICAP profiles for multiple proxy servers (ICAP clients) with different configuration requirements.

- The default profile built into FortiSandbox can be edited but not deleted.
- Disabling both *Receive File* and *Receive URL* for the default profile prevents clients that do not match any user-defined profile from receiving service.
- Configuring a new profile will override the settings defined in the *Default* profile for matched proxy server by IP.
- If a client does not match a user-defined profile the *Default* profile is applied.
- The maximum number of ICAP profiles permitted is 32, including the default profile and up to 31 user-created profiles.

Profile Name	Client IP Address	Receive URL	Receive File	URL hold policy	File hold policy
Default		✓	✓	Full Scan	Full Scan
example		✓	✓	Quick Scan	Quick Scan

To create an ICAP profile:

1. Go to *Security Fabric > Adapter*.
2. Select the *ICAP* adapter and click *Edit*.
3. Under *ICAP Profiles*, click *Create New*. The *Create New* pane opens.
4. Configure the profile and click *OK*.

Profile Name	Enter a name for the profile.
---------------------	-------------------------------

Client IP Addresses

Enter the client IP address. Separate multiple IPs with a comma.

Receive URL

Enable to allow the ICAP server to receive URLs.

- *URLs with selected risk and above will be blocked:*
Set the minimum level of risk for the URLs to be blocked by ICAP (*Low Risk, Medium Risk, and High Risk*).

- *Keep the URL on the client side until these scans are completed*
 - *Quick Scan:* Keep the file on the client-side until Quick Scan is completed.

The URL will be checked against the FDN Web Filtering service. If its category is either malicious or unethical, a suspicious rating will be returned to the client side.

User-defined [Allow/Block list](#), [Customized Rating](#), or [Overridden Verdict](#) rules are not checked.

- *Full Scan:* Keep the file on the client-side until Full Scan is completed.

Verdict timeout: Specifies the number of seconds the ICAP server will wait for a final verdict after the file is submitted. If no verdict is received within the timeout period, the ICAP server returns a *204 No Content* (no modification) response, or a *200 OK* with the original content if the client does not support 204.

Receive File

Enable to allow the ICAP server to receive files.

- *Files with selected risk and above will be blocked:*
Set the minimum level of risk for the Files to be blocked by ICAP (*Low Risk, Medium Risk, and High Risk*).

- *Return a CDR copy of the file in RESPMOD mode when it's available*
Before using this option, enable the *Content Disarm and Reconstruction* setting on the *Profile > Advanced* page.

- *Keep the file on the client side until these scans are completed*
 - *Quick Scan:* Keep the file on the client-side until Quick Scan is completed.

Enable at least one of the following options: *AV Scan*, *Static Analysis* or *Cloud Query*.

For *Static Analysis*, the following items are not checked in the file:

- Embedded QR code or URL inside file
- User-defined [Allow/Block list](#), [Customized Rating](#), or [Overridden Verdict](#) or [YARA](#) rules
- *Full Scan:* Keep the file on the client-side until Full Scan is completed.
 - *Verdict timeout:* Specifies the number of seconds the ICAP server will wait for a final verdict after the file is submitted. If no verdict is received within the timeout period, the ICAP server responds to the client with a *No Modification* status.

5. Click *Apply* on the *ICAP Settings* page.

Content Disarm and Reconstruction (CDR) for ICAP

ICAP CDR enhances security by sanitizing potentially malicious content from supported file types, such as PDF and Microsoft Office documents. This process is performed in RESPMOD mode (response modification), meaning files are sanitized *before* being delivered to the end user.

CDR is particularly effective against embedded threats by removing active content (e.g., macros, JavaScript) while preserving the readable parts of a document.

CDR Activation Conditions

CDR behavior is influenced by the selected scanning mode. There are three modes:

Quick Scan Enabled:

- The file is initially scanned by the ICAP antivirus engine and cloud query.
- If the verdict is CLEAN, CDR will be performed.

Full Scan Enabled:

- A deeper analysis is triggered, entering a virtual machine for behavior-based inspection.
- If the scan is not completed within the timeout period and no verdict is returned, CDR is triggered as a fallback.

Bypass Scan:

- Neither *Quick Scan* nor *Full Scan* is enabled.
- The system performs CDR directly.

Health Check for ICAP Servers

Health checks for ICAP servers are typically handled by the ICAP client, but you can also perform manual checks if needed. Three common levels of health monitoring are available: *Connection Level*, *Service Level*, and *Mode Level*. Choose the appropriate level based on your requirements.

Connection Level	Verifies that a network connection to the ICAP server is active on the configured TCP port (default: 1344 or 11344). This can be manually tested by checking if the port is open (e.g., using telnet). A successful connection confirms that the server is reachable at the network level.
Service Level	Confirms that the ICAP service is functioning by sending an <i>OPTIONS</i> request to the ICAP server with a specified service name (e.g., <i>OPTIONS icap://ICAP_SERVER/respmo ICAP/1.0</i>) on the configured port. A successful response, such as <i>ICAP/1.0 200 OK</i> , indicates that the server is operational at the service level.
Mode Level	Ensures that specific ICAP modes, such as REQMOD or RESPMOD, are functioning as expected. This is useful for validating mode-specific functionality.

If you only need to verify that the ICAP server is active and the service is operational, the *Service Level* check (using an OPTIONS query) is sufficient. For deeper analysis, such as examining the TCP header, packet capture tools like Tcpcdump or Wireshark are required.

BCC Adapter

FortiSandbox has a BCC adapter to receive and scan forwarded emails from upstream MTA servers. FortiSandbox extracts attachment files and URLs from the email body and sends them to the job queue.



This feature is for information only, like sniffer mode. It will not block any email.

To configure the FortiSandbox:

1. Enable the BCC adapter:
 - a. Go to *Security Fabric > Adapter*.
 - b. Select *BCC* and click *Edit* in the toolbar. The BCC adapter is disabled by default.
 - c. Enable the BCC adapter.
 - d. Configure the adapter and click *Apply*.

SMTP Port	Enter the SMTP port that the FortiSandbox listens on to receive emails. The default port is 25.
Certificate	Select the server certificate for the BCC server from the dropdown list. You can select a certificate from the list or leave it blank if needed. To import certificates and keys, go to <i>System > Certificates</i> and click <i>Import</i> .
Interface	Select the interface that the FortiSandbox listens on. The default is port1.



The number of URLs to extract from the email body can be configured in *Scan Profile > Advanced > URL count to be extracted from email body*.

2. Enable file submission from the BCC adapter to create log events:
 - a. Go to *Log & Report > Settings*.
 - b. Under *Log submission events from the following sources*, select *BCC Adapter*.
 - c. Click *OK*.
3. To view BCC adapter debug logs in run time, execute the following CLI command:



```
diagnose-debug adapter_bcc
```

For more information about the `diagnose-debug` command, see the *FortiSandbox CLI Reference*.

To configure the upstream MTA:

The steps below are an example of how to configure the upstream MTA in FortiMail.

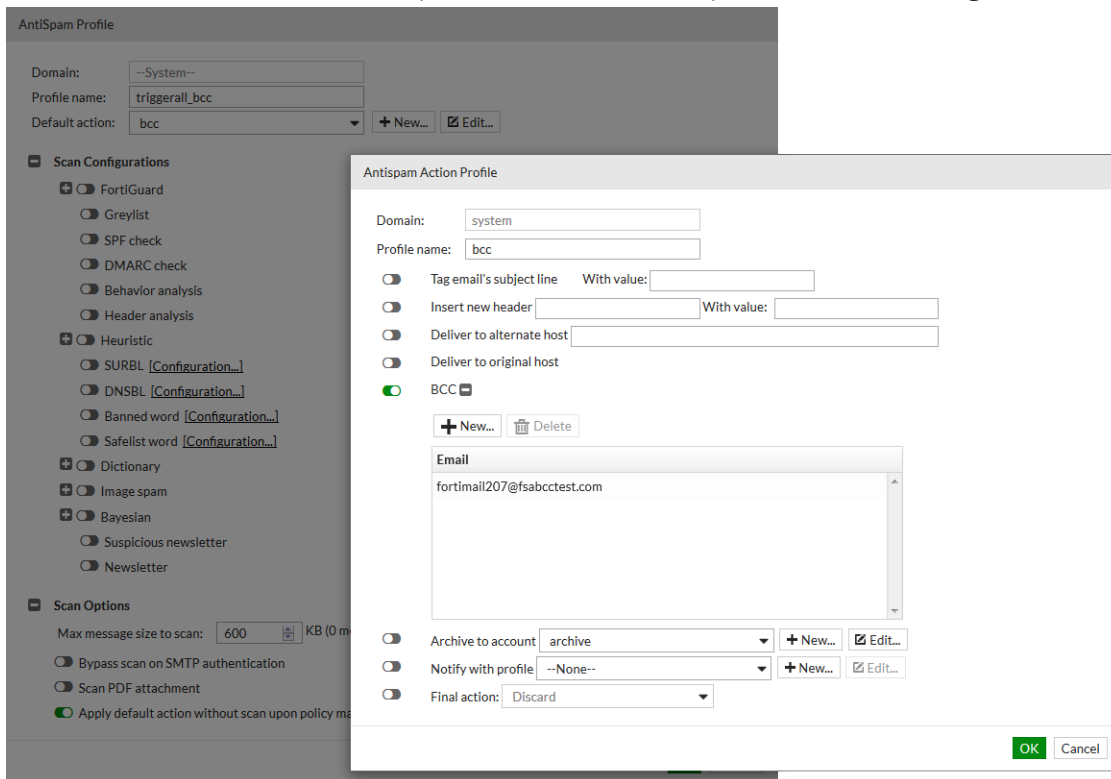
1. Go to *Profile > AntiSpam* and create a new AntiSpam profile:
 - a. Enable *Apply default action without scan upon policy match*.
 - b. Configure *BCC* as the default action.
 - c. Edit the default action: enable *BCC*, and add a BCC address, such as *fortimail207@fsabcctest.com*.



2. Go to *Policy > Recipient Policy*:
 - a. Select the domain for forwarding emails to the FortiSandbox, and apply the new AntiSpam profile.
 - b. Add a new inbound policy, select the domain for forwarding emails to the FortiSandbox, and apply the new AntiSpam profile.

- c. Add a new outbound policy, select the domain for forwarding emails to the FortiSandbox, and apply the new AntiSpam profile.

3. Go to *Policy > Access Control*:

- a. On the *Delivery* tab, add a TLS policy with a recipient pattern matching the previously added BCC address (in this example: **@fsabcctest.com*).

b. Set *TLS Profile* as *none* or *Preferred*.

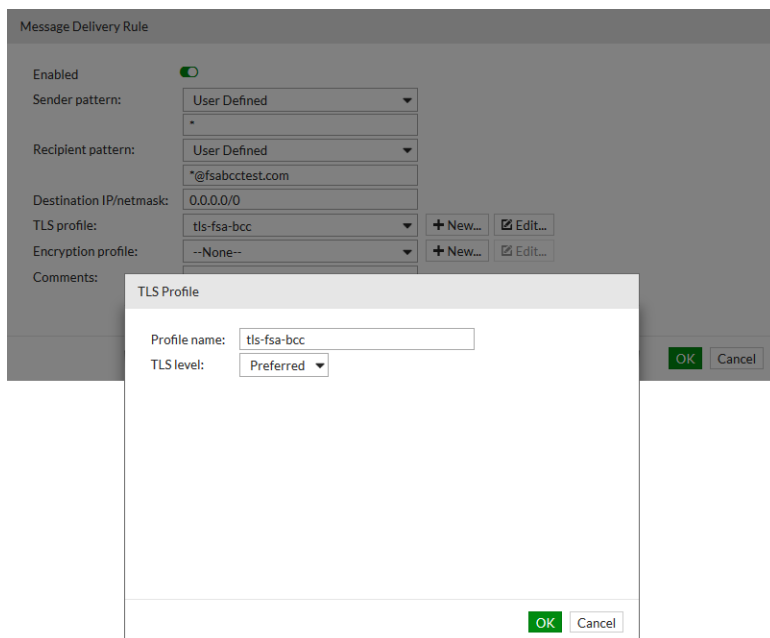

- 4.** For the DNS server that your upstream mail server is accessing, add an MX record for the BCC email domain to resolve the FortiSandbox device's IP address. In the above example, the email domain is fsabcctest.com and the IP address is that of the port that is receiving the email.

MTA adapter

The *Mail-Transfer-Agent* (MTA) adapter feature allows email servers like Sendmail to relay emails to FortiSandbox via SMTP protocol.

The adapter requires a subscription license which is automatically downloaded through FortiGuard. The subscription has a limited per-mailbox seat count. Each email address of the monitored domain is counted as a seat. When the mailbox seat count limit is reached, the system logs a warning message on the event log and GUI. An additional 10% is allowed.

The FortiSandbox extracts files and URLs on the email being relayed. All email addresses in the To, CC, and BCC fields are counted and tracked for those matching the configured email domains. An email is relayed and not scanned if it meets the following criteria:

- There is no valid MTA subscription license.
- The FortiSandbox disk usage exceeds the defined percentage.

If quarantine is disabled and an email scan result is suspicious or malicious, a tag will be prepended to the original email subject line and is relayed to the recipient email address. The tag is configurable on the MTA configuration page. Otherwise, the email is relayed without change.

If quarantine is enabled and an email scan result is suspicious or malicious and matches the defined quarantine rating level, the email is quarantined and the recipient will not receive the email. If you have enabled *Send alert email to receivers when email is quarantined*, the recipient will receive an alert email stating that an email is quarantined. The quarantined emails will be saved in FortiSandbox until you release or delete them (see, [Processing quarantined emails](#)).

To configure the MTA adapter:

1. Go to *Security Fabric > Adapter*.
2. Select the MTA adapter and click *Edit*.
3. Enable the adapter.
4. Configure the following settings and then click *Apply*.

Tag For Suspicious/Malicious Mails	If the email scan result is malicious or suspicious, this text is prefixed to the email subject line. The next hop email server can act accordingly.
Email Scan Timeout (Minutes)	Maximum time FortiSandbox waits for the scan result. If there is no result after timeout, the email is released to recipient.
Message Size Limit (mb)	Maximum size of email to accept to scan.
Disk Usage Upper Limit (%)	Maximum percentage disk space used before MTA stops scanning emails and only routes emails.
Relay Emails for Domain Names	Domain names of email server to be relayed from this FortiSandbox. When FortiSandbox receives these emails and finishes scan, FortiSandbox relays these emails if they are clean, or quarantines them if malicious.
	 <p>If you change or remove a domain, the emails submitted to that domain before they are relayed will be in the <i>Unsent</i> page.</p>
Next Hop Mail Server Name	Enter the IP address or domain name of the email server to which relayed emails will be sent.
Certificate	Click the dropdown to select the server certificate for the MTA server. You may select a certificate from the dropdown menu or leave it blank if necessary. To import certificates and keys, go to <i>System > Certificates</i> and click <i>Import</i> .
Local Interface	Select the local interface.
Local SMTP Port	Specify the local SMTP port.
Quarantine emails whose content has the following ratings	Select the ratings of emails to quarantine.
Send alert email to receivers when email is quarantined	When email is quarantined, send alert email as configured.
Email Sender	The <i>From</i> field of alert email sent.
Email Subject	Email subject line of alert email sent.
Email Content Template	Text in alert email body.



The number of URLs to extract from the email body can be configured in *Scan Profile > Advanced > URL count to be extracted from email body*.

Processing quarantined emails

To release or delete quarantined emails:

1. Go to *Security Fabric > Adapter*. If there are quarantined emails, the number of quarantined emails is displayed as a hyperlink next the MTA adapter name (for example *Quarantined:89*).
2. Click the *Quarantined* link to display the list of quarantined emails.
 - To view job details, click the *View Details* icon.
 - To download the job files as a zip file, click the *Download Email File* icon.
 - To preview the original email, click the *Preview Email* icon.
 - To release the quarantined email to recipient, select the emails and click the *Release Email* icon.
 - To delete the quarantined email, select the emails and click the *Delete Email* icon.

Processing unsend emails

When using the MTA adapter, emails may occasionally remain unsend due to issues such as network interruptions or destination server unavailability. In these cases, the email cannot be relayed successfully and will appear on the *Unsent* page under *Security Fabric > Adapter*. This page provides options to review, resend, or delete any undelivered emails.

To resend or delete unsend emails:

1. Go to *Security Fabric > Adapter*. If there are unsend emails, the number of unsend emails is displayed beside the MTA adapter name.
2. Click the unsend link to display the list of unsend emails.
 - To view job details, click the *View Details* icon.
 - To download the job files as a zip file, click the *Download Email* icon.
 - To preview the original email, click the *Preview Email* icon or double click the record.
 - To resend the unsend emails, select the emails and click the *Resend* icon.
 - To delete the unsend emails, select the emails and click the *Delete* icon.

Using MTA in HA cluster

In an HA cluster, the MTA adapter is functional only on the primary node. The primary node aggregates the seat counts from all nodes in the cluster and uses the sum as the cluster's seat count.

- To view the account usage in the GUI of the primary node, go to *Adapter > MTA*. In the *Status* column click the *Click To View MTA Contract* icon.
- To view the *Mail Transfer Agent Service* account information from each node in the cluster, run the CLI command: `vm-license -l`.

The configuration is identical to that of a standalone device. When the primary node receives MTA jobs, it distributes them to either itself or the worker nodes, depending on the workload and VM association.



In a cluster, configure the *Local Interface* to the interface of the cluster IP address so that the secondary can take over the configuration in a failover.

- To view jobs in a cluster, go to *HA cluster > Job Summary*.
- To view logs in the primary node, go to *Log & Report > Events > Job Events*.
- To view logs in a worker node, go to *Log & Report > Events > All Events*.

Network Share

FortiSandbox can scan files stored in a network share folder and optionally quarantine files of any rating. Go to *Security Fabric > Network Share* to view and configure network share information.

Network Share scans can be scheduled or run on-demand. Connectivity with the Network Share can be tested. For information about data storage, see [Network share record retention on page 59](#).

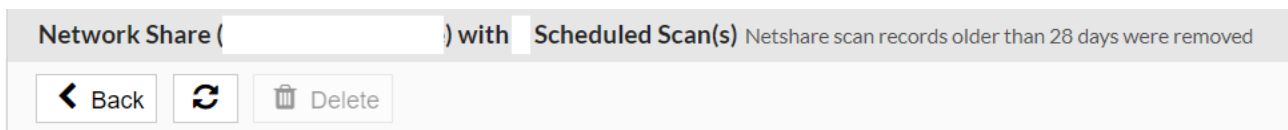

Network Share is only available in the Primary node of an HA cluster.



To improve the scan performance, delete any empty sub-folders in the Network Share.

The following options are available:

Create New	Create a new network share.
Edit	Edit the selected entry.
Clone	Clone the selected entry. Only the <i>Network Share Name</i> is different. All other settings are the same as the original.
Delete	Delete the selected entry.
Scan Now	Schedule an immediate scan for the selected entry.
Scan Details	View the selected entry's scheduled scan entries.

Test Connection	Test the selected entry's connection. The result is displayed in the banner at the bottom right corner.
------------------------	---

The following information is displayed:

Name	Name of the network share.
Scan Scheduled	Display if the scan scheduled is enabled or not. Scheduled network scans are done in parallel.
Type	Mount type.
Share Path	Network share path.
Quarantine	Displays if quarantine is enabled or disabled.
Sanitized	Displays if sanitized is enabled or disabled.
Enabled	Displays if the network share is enabled or disabled. FortiSandbox does not run the scheduled scans when disabled.
Status	Displays if the network share status is accessible or down. Click <i>Test Connection</i> to show the connection status (AWS S3, Azure Blob Storage, Google Cloud Storage, MS One Drive, MS SharePoint and SFTP).

To create a new network share:

1. Go to *Security Fabric > Network Share*.
2. Click *Create New*.
3. Configure the following options and click *OK*.

Enabled	Select to enable network share configuration. If network share is not enabled, its scheduled scan will not run.
Mount Type	Select the mount type. The following options are available: <ul style="list-style-type: none"> • CIFS (SMB v1.0, v2.0, v2.1, v3.0 and v3.1) • NFSv2, NFSv3, NFSv4 • AWS S3, AWS S3 BJ, AWS S3 NX. See AWS S3 Settings on page 87. • Azure File Share. See Azure File System on page 88. • Azure Blob Storage. See Azure Blob Storage on page 88. • Google Cloud Storage. See: Google Cloud on page 91 • Microsoft OneDrive. See Microsoft OneDrive on page 97. • Microsoft SharePoint. See Microsoft SharePoint on page 101. • SFTP <p>For domain-based DFS namespace, ensure the domain name can be resolved with the system Primary DNS server.</p>
Network Share Name	Network share name.
Server Name/IP	Server FQDN or IP address.
Share Path	File share path in the format /path1/path2.

Scan Files Of Specified Pattern	Include or exclude files which match a file name pattern.
File Name Pattern	File name pattern.
Username, Password, Confirm Password	Username and password. For domain users, use the format domain_name\user_name.
Scan Job Priority	When multiple network share scans run at the same time, higher priority scans get more scan power.
Keep A Copy Of Original File On FortiSandbox	<p>Keep a copy of the original file on FortiSandbox.</p> <p>NOTE: Configuring this setting may affect when the original files are kept, deleted and transferred based on the <i>Quarantine</i> settings. For detailed information, see Configure Network share to keep, delete or transfer files in the <i>FortiSandbox Best Practice</i> guide.</p>
Skip scanning unchanged files after first round of scan	<ul style="list-style-type: none"> • <i>Skip dynamic scan only:</i> Allows files to bypass resource-intensive VM scans while still ensuring that files undergo static scans. However, this option requires downloading the files from remote storage, which will incur cost. • <i>Skip all types of scans:</i> FortiSandbox will not perform any scans on the files. Files will not be downloaded from remote storage. <p>For more information about skip scanning, see Skip scanning unchanged files after first round of scan on page 59.</p>
Enable Quarantine of Malicious Files	<p>Quarantine files with a Malicious rating in the selected location.</p> <p>Quarantined files are put in a folder with the name of the Job ID and each file is renamed with the Job ID for that file and a meta file with more information.</p>
Enable Quarantine of Suspicious - High Risk files	<p>Quarantine suspicious files with a High Risk rating in the selected location.</p> <p>Quarantined files are put in a folder with the name of the Job ID and each file is renamed with the Job ID for that file and a meta file with more information.</p>
Enable Quarantine of Suspicious - Medium Risk files	<p>Quarantine suspicious files with a Medium Risk rating in the selected location.</p> <p>Quarantined files are put in a folder with the name of the Job ID and each file is renamed with the Job ID for that file and a meta file with more information.</p>
Enable Quarantine of Suspicious - Low Risk files	<p>Quarantine suspicious files with a Low Risk rating in the selected location.</p> <p>Quarantined files are put in a folder with the name of the Job ID and each file is renamed with the Job ID for that file and a meta file with more information.</p>
Enable Quarantine of Other rating files	<p>Quarantine suspicious files with a Other rating in the selected location.</p>

	Quarantined files are put in a folder with the name of the Job ID and each file is renamed with the Job ID for that file and a meta file with more information.
Enable copying or moving clean files to a sanitized location	Copy or move files with a Clean rating to another location. By default, a new folder is created for each scheduled scan job in the sanitized location and all clean files are copied into it with the original folder structure. To save space, uncheck <i>Keep a complete copy of clean files for every scheduled scan</i> so that files of the same path have only one copy in the sanitized location.
Enable Scheduled Scan	Enable scheduled scan and specify the schedule type.
Description	Optional description for the network share entry.
Send notification email after each scan	Email a summary report for each network share scan to the specified users.



When a file is moved, to leave a copy in its original location, go to the *Quarantine* edit page to enable *Leave a File At Source Location* and select *A Copy of Original File*.



Conserve Mode:

FortiSandbox goes into Conserve Mode once the pending jobs count is over 10,000 and exits after the pending jobs count is less than 5,000. There is no difference between standalone and HA cluster.

In Conserve Mode, FortiSandbox stops downloading files from Network Share and continues processing the downloaded files until the pending jobs count is less than 5,000. After exiting Conserve Mode, FortiSandbox resumes downloading files from the Network Share until the entire submission is complete, even if it enters and exits conserve mode multiple times during the process.

A warning level system log entry alerts you of the event.

To run a network share scan immediately:

1. Go to *Security Fabric > Network Share*.
2. Select a share.
3. Click *Scan Now* to immediately run the scan. If you are an admin with *Prioritize Netshare Scan* privileges, then you have the option of selecting *Prioritize Scan*. For information, see [Netshare Groups on page 161](#).

To test network share connectivity:

1. Go to *Security Fabric > Network Share*.
2. Select a share.
3. Click *Test Connection* to test connectivity with the network share.

Network share record retention

Network Share scan records are retained for four weeks (28 days), regardless of the *Settings > Data Storage* settings (see, [Settings on page 206](#)). Network share records only include the filename, filepath, verdict and scan time. The scan details such as files, logs, tracers, and metadata are deleted according to the *Data Storage* settings.

For example, if you set *Data Storage* to 24 hours:

- The scan details (files, logs, tracers, and metadata) are deleted after 24 hours.
- The network share records (the filename, filepath, verdict and scan time) are retained for 28 days.

Skip scanning unchanged files after first round of scan

FortiSandbox supports two types of scans: Static Scan and Dynamic Scan. Static Scan uses the Virus database and AI technologies which are usually done in several seconds with less system resources. Dynamic Scan needs to spawn a VM instance and analyze the file/URL in the VM. This usually takes several minutes to complete and requires more system resources.

Enabling skip scanning saves time and resources by skip scanning unchanged files after the first round of scanning.

Scan Details

The *Scan Details* page shows scheduled scans for the selected network share.

To view the Scan Details:

1. Go to *Security Fabric > Network Share* and select a network share.
2. In the toolbar, click *Scan Details*.



The following information is shown:

Back	Go back to the network share page.
Refresh	Refresh the scans page.
Delete	Delete the selected scan.
Total	The total number of finished scanned jobs.
Start	The start time of the scan.
End	The end time of the scan.
Finished	Percentage of files that finished the scan. Click on the number to show details.

Malicious	The number of Malicious files discovered. Click on the number to show detected Malicious rating files. The number of quarantined files are also displayed.
Suspicious	The number of Suspicious files discovered, divided in High Risk, Medium Risk and Low Risk columns. Click on the number to show detected Suspicious rating files. The number of quarantined files are also displayed.
Clean	The number of Clean files detected. Click on the number to show detected Clean rating files.
Others	The number of files that do not finish scanning for various reasons. Click on the number to show them. The number of quarantined files are also displayed.

To view the job details, click a numbered link and then click the *Job Detail* button.



- Job details are not displayed if the job information was deleted based on the settings in the *the System > Settings > Data Storage* page.
- All the Netshare Scan records will be deleted when the Primary node in a HA cluster reboots.
- In Standalone Mode, an unfinished Netshare Scan will not resume after system boots up.

Quarantine

Create and edit quarantine locations in the Security Fabric. Quarantine supports SMB, NFS, AWS S3, Azure File Share, Azure Blob Storage, Google Cloud Storage, Microsoft OneDrive, Microsoft SharePoint and SFTP mount types. To view the quarantine information, go to *Security Fabric > Quarantine* .



Quarantine is only available in the Primary node of an HA cluster

The following options are available:

Create New	Select to create a new quarantine location.
Edit	Select an entry from the list and then select <i>Edit</i> in the toolbar to edit the entry selected. When editing an entry you can select to test connectivity to ensure that the quarantine location is accessible.
Delete	Select an entry from the list and then select <i>Delete</i> in the toolbar to remove the entry selected.
Test Connection	Test the selected entry's connection. The result is displayed in the banner at the bottom right corner.

The following information is displayed:

Name	The name of the quarantine location.
Type	The mount type.
Share Path	The file share path.
Enabled	Displays if the quarantine location is enabled.
Status	<p>Displays the quarantine access status. One of the following states:</p> <ul style="list-style-type: none"> • Quarantine is Accessible • Quarantine Down <p>Click <i>Test Connection</i> to show the connection status (AWS S3, Azure Blob Storage, Google Cloud Storage, Microsoft OneDrive, Microsoft SharePoint and SFTP).</p>

To create a new quarantine entry:

1. Go to *Security Fabric > Quarantine*.
2. Click the *Create New* button from the toolbar.
3. Configure the following options:

Enabled	Select to enable quarantine location.
Quarantine Name	Enter the quarantine name.
Mount Type	<p>Select the mount type from the dropdown list. The following options are available:</p> <ul style="list-style-type: none"> • CIFS (SMB v1.0, v2.0, v2.1, v3.0 and v3.1) • NFSv2, NFSv3, NFSv4 • AWS S3, AWS S3 BJ, AWS S3 NX. See AWS S3 Settings on page 87. • Azure File Share. See Azure File System on page 88. • Azure Blob Storage. See Azure Blob Storage on page 88. • Google Cloud Storage. See: Google Cloud on page 91 • Microsoft OneDrive. See Microsoft OneDrive on page 97. • Microsoft SharePoint. See Microsoft SharePoint on page 101. • SFTP
Server Name/IP	Enter the server fully qualified domain name (FQDN) or IP address.
Share Path	Enter the file share path. In the format /path1/path2.
Username	Enter a user name. For a domain user, use the format domain_name\user_name.
Password	Enter the password.
Confirm Password	Enter the password a second time for verification.
Keep Original File At Current Location	Select to keep the original file at the current location when a file is quarantined from a network share. By default, the original file is kept at its current location when being moved.

NOTE: Configuring this setting may affect when the original files are kept, deleted and transferred after a network share scan. For detailed information, see [Configure Network share to keep, delete or transfer files](#) in the *FortiSandbox Best Practice* guide.

- Enable/Disable**
- *Enable:* Keep the original file at its network share location.
 - *Disable:* Allow FSA to delete the original file from the network share location.
- By default, the original file is kept at its current location.

A Copy of Original File Select to keep the original file at the current network share location without change. By default, the original file is kept at its current location without change.

A Placeholder File Showing File is Quarantined Select to allow FortiSandbox remove the original file from the network share location and .quarantine files generated for non CLEAN files.

Description Enter an optional description for the quarantine location entry.

4. Select *OK* to save the entry.

To edit a quarantine:

1. Go to *Security Fabric > Quarantine*.
2. Select a quarantine.
3. Click the *Edit* button from the toolbar.
4. Make the necessary changes.
5. Click *OK* to save the entry.

To delete a quarantine:

1. Go to *Security Fabric > Quarantine*.
2. Select a quarantine.
3. Click the *Delete* button from the toolbar.
4. Click *Yes I'm sure* button from the *Are you sure* confirmation box.

Sniffer

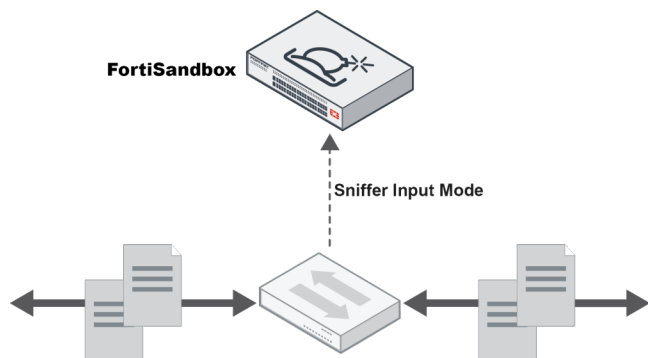

Sniffer mode is a suitable deployment option for adding protection capabilities to existing threat protection systems from various vendors. It allows you to configure your FortiSandbox to sniff all network traffic on the specified interfaces.

FortiSandbox extracts files and URLs from the network traffic for file-based and network-alert detections. The files and URLs are scanned and may enter the Dynamic Scan as configured. When rated as suspicious, the FortiSandbox can send either TCP reset packets or replacement messages as configured and supported.

Sniffer mode supports the following protocols: HTTP, FTP, POP3, IMAP, SMTP, SMB, DNS and raw TCP. It relies on network traffic received from spanned switch ports even from multiple interfaces. For example, when FortiSandbox is deployed with a network tap device, you can sniff both the incoming and outgoing traffic on separate FortiSandbox interfaces. Both port1 and port3 interfaces cannot be used for this feature since those are for device management and VM access to the Internet, respectively.

To enable and configure sniffer mode:

1. Go to *Security Fabric > Sniffer*.
2. Configure the following settings:

Sniffed Interfaces	Select the interface to monitor.
Interface MTU	<p>The Maximum Transmission Unit (MTU) in bytes.</p> <p>Configure this setting to provide a higher level of network isolation and VLAN management for Q-in-Q traffic.</p> <p>You can set the range between 1200-9000 bytes. The recommended range is between 1500-9000 bytes. The default value is 1500. However, it is important to adjust the MTU based on the specific requirements and characteristics of your network infrastructure.</p> <p>Note: This setting applies only to the sniffed interface. If the port is not used for a sniffer, the MTU value will revert to the value before it was set as a sniffed port.</p>

Limit the number for TCP RST request

This setting determines the maximum number of TCP RST packets that the FortiSandbox unit will send to terminate a TCP session. Acceptable values range from 1 to 255. By default, the setting is 0, indicating no limit on the number of packets.

This option is only visible when the *TCP RST* feature is enabled under either *Enable file based detection* or *Enable network alert detection*.

Network interfaces to send out TCP RST traffic

As an administrator, you can define the policy for dispatching RST traffic.

- *Follow system routing settings*: Adhere to the static routing table in *System > Static Route*
- *Through dedicated ports*: When opting for dedicated ports, multiple selections are permitted.

This option is only visible when the *TCP RST* feature is enabled under either *Enable file based detection* or *Enable network alert detection*.

Dedicated ports sending TCP RST packets will be based on the network traffic. For optimal performance, it is recommended to connect the ports you select directly to the client or server's LAN.

Enable file based detection

Select the checkbox to enable file based detection.

Enable support TCP RST

View Sniffer generated TCP RST packages from *Scan Policy and Object > TCP RST Package*.

Only HTTP URLs are supported.

Enable *Send client a warning message with a comfort page when TCP* is disconnected to notify the user the URL is blocked and cannot be downloaded. Click the edit icon to customize the font size, background and font color with the HTML editor. Source code must contain “%%URL%%” to display the blocked URL.

Enable logging for TCP RST option will record whether FSA has sent RST packets in *Log & Events > Events > Job Events*.

Keep incomplete files

Keep files without completed TCP sessions. Select the checkbox to keep incomplete files. Sometimes incomplete files can be useful to detect known viruses.

Enable Conserve mode

When conserve mode is enabled, the sniffer might enter conserve mode if it is too busy, such as when there are too many jobs in the pending queue (250K), sniffed traffic exceeds optimal throughput, or HDD/RAM disk usage is too high. In conserve mode, the sniffer only extracts executable (.exe) and MS Office files.

Optimal traffic throughput:

- FSA-3000G: 9.6Gbps

- FSA-3000F: 9.6Gbps
- FSA-3000E: 8 Gbps
- FSA-2000E: 4 Gbps
- FSA-1500G: 4 Gbps
- FSA-1000F: 1 Gbps
- FSA-1000F-DC: 1 Gbps
- FSA-500G: 500 Mbps
- FSA-500F: 500 Mbps
- FSA-VM00: 1 Gbps

Max file size The maximum size of files captured by the sniffer. Enter a value in the text box. The default and maximum file size value are 2 MB and 200 MB, respectively.
Files that exceed the maximum file size are not sent to FortiSandbox.

Service Types Select the traffic protocol that the sniffer will work on. Options include: *FTP, HTTP, IMAP, POP3, SMB, OTHER* and *SMTP*.
The *OTHER* service type is for raw TCP protocol traffic.

File Types Select the file types to extract from traffic. When *All* is checked, all files in the traffic will be extracted. Users can also add extra file extensions by entering it in the *File Types* field and clicking *Add > OK*. The user can delete it later by clicking the Trash can icon beside it and clicking *OK*.
To extract URLs from the email body, select *email* file type, then configure *Number of URLs* in *Scan Profile > Advanced > URL count to be extracted from email body*.

Enable network alert detection Select the checkbox to enable network alerts detection. This feature detects sniffed live traffic for connections to botnet servers and intrusion attacks and visited suspicious web sites with Fortinet IPS and Web Filtering technologies.
Alerts can be viewed in the *Network Alerts* page.
For URL visits, certain categories can be treated as benign in *Scan Policy and Object > Web Category*.

Enable TCP RST for IPS The "Enable TCP RST for IPS" option blocks traffic from URLs detected by the attack and botnet systems. If a TCP connection is terminated, a notification informs the user that the URL is blocked and cannot be accessed.



When an interface is used in sniffer mode, it will lose its IP address. The interface settings cannot be changed.



Currently file-based detection selected TCP RST dedicated ports will be the same as network alert TCP RST dedicated ports. If one side changes, another side will change automatically.

FortiNDR

FortiSandbox can use FortiNDR as one method to generate verdicts. If FortiNDR rates a file as clean, and all other methods gives that file a clean verdict, then FortiSandbox will not go into VM scan. If FortiNDR rates a file as malicious or high risk, then FortiSandbox will also rate it as malicious or high risk. For all other FortiNDR ratings, FortiSandbox follows the regular scan flow and give a final verdict after using all methods including VM scan.

Prerequisites

- FortiNDR server is installed and licensed.
- FortiNDR is higher than v1.5.0 build 0104.
- You have the token from FortiNDR *System > Administrator > Edit > API Key*.



FortiNDR v1.5.0 -1.5.3 is named *FortiAI*. For more information, see the FortiAI product page in the [Fortinet Document Library](#).

To configure FortiNDR as a verdict method:

1. Go to *Security Fabric > FortiNDR*.
2. Click *Enable*.

3. Configure the following options.

Server IP	IP address of FortiNDR server.
Token	The token from FortiNDR <i>System > Administrator > Edit > API Key</i> .

Rating Timeout (Seconds)	The maximum time to wait for FortiNDR to give a verdict. If a file does not get a verdict from FortiNDR by this time, the file goes into normal scan flow.
Uploading Timeout (Seconds)	The maximum time to upload a file to FortiNDR. If a file does not upload to FortiNDR by this time, the file goes into normal scan flow.
Maximum File Size (KB)	The maximum file size to upload to FortiNDR. Oversize files are not sent to FortiNDR, they continue with regular scan flow.

- Go to *Scan Policy and Object > Scan Profile > Pre-Filter*.
- Enable *FortiNDR entrust* and click *Apply*.

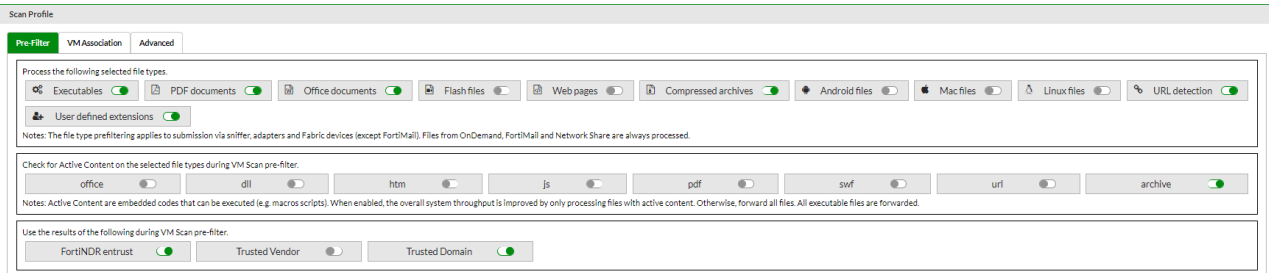

Scan Job

Job Queue

In this page, users can view the current pending job number, average scan time, and arrival rate of each job queue. The associated VM is also displayed for each queue. The user can click the VM name to go to the *Scan Profile* page and change its settings.

Users can use this page's information to ensure each Job Queue is not piling up with too many jobs. If there are a lot of jobs pending in the Job Queue, the user can try to associate it with less VM types and/or allocate more clone numbers to its associated VM types.

To refresh the data, click the *Job Queue* menu again or the *Refresh* button on the top of the web site.

Input Source	File Type	Queued #	Ave Scan Time in Last 24 hrs (s)	Expected Finish Time	Arrival Rate (Last 1 hr)	VM Type (Clone #)
FortiMail URL	URL detection	29		00:58:00		
FortiMail	Executables/DLL/VBS/BAT/PS1/JAR/MSI/WSF/JS files	23		00:46:00		WIN7X86VM(4) Link
URL On-Demand	URL detection	11		00:22:00		
Device	Executables/DLL/VBS/BAT/PS1/JAR/MSI/WSF/JS files	0	3		22	WIN7X86VM(4) Link
Device	User defined extensions	0	388			WIN7X64VM(4) Link , WIN7X86VM(4) Link
Device	Microsoft Office files (Word, Excel, PowerPoint files etc)	0	90		5	WIN7X86VM(4) Link
Device	PDF files	0	5		25	WIN7X86VM(4) Link
URL Device	URL detection	0	1		64	
Non Sandboxing files	Non Sandboxing files	8				
FortiMail	Microsoft Office files (Word, Excel, PowerPoint files etc)	4		00:08:00		WIN7X86VM(4) Link
FortiMail	PDF files	4		00:08:00		WIN7X86VM(4) Link

The following options are available:

Chart icon	Click the <i>Chart</i> icon beside the VM Type to display the VM's <i>Usage Chart</i> .
Trash icon	Click the <i>Trash</i> icon beside the Pending Job Number purges the job queue.
Prioritize	Click the <i>Prioritize</i> button takes you to the <i>Job Queue Priority List</i> page where you can adjust the list.

The following information is displayed:

Input Source	The type of Input Source. Input source types can be the following values: <ul style="list-style-type: none">• On-Demand• File RPC• Device• Sniffer• Adapter• Network Share• URL On-Demand• URL RPC
---------------------	---

	<ul style="list-style-type: none"> • URL Device • URL Adapter
File Type	<p>File types can be one of the following values:</p> <ul style="list-style-type: none"> • Executables /DLL/VBS/BAT/PS1/JAR/MSI/WSF files • Microsoft Office files (Word, Excel, Powerpoint etc) • Adobe Flash files • Archive files (extensions: .7z, xz, .bz2, .gz, .tar, .zip, .Z, .kgb, .ace, etc.) • PDF files • Static Web files • Android files • MACOSX files • URL detection • User defined extensions • Job Queue Assignment Pending files (files received from input sources and not yet processed) • Non Sandboxed files (files that do not enter the Sandboxing scan step according to the current Scan Profile settings. If the Scan Profile settings are changed, they may enter the Sandboxing scan step eventually.)
Queued #	<p>Current pending job number.</p> <p>A <i>Trash Can</i> appears beside the pending job number. Clicking on the <i>Trash Can</i> icon purges the job queue.</p> <p>Select the icon next to the <i>Non Sandboxing files</i> Input Source to expand the selection to view and purge non-sandboxing files separately.</p>
Ave Scan Time in Last 24 hrs (s)	Average scan time of one file in the last 24 hours, in seconds.
Expected Finish Time	The expected time when the pending jobs will finish.
Arrival Rate (Last 1 hr)	Files put in the Job Queue in the last hour.
VM Type (Clone #)	<p>The VM type with its clone number.</p> <p>A <i>Chart</i> icon appears beside the VM Type (Clone#). If you click on the <i>Chart</i> icon, the VM's usage chart appears. This chart shows a rough percentage of used clones of this VM type across time. If the usage percentage is consistently at a high level across time, the user should consider allocating more clone numbers to it.</p>

VM Jobs

Go to *Scan Job > VM Jobs* to view files currently scanned inside the VM. The page displays the file name and progress. To view a screenshot of the running scan, click the *VM Screenshot* button and then the *PNG Link* button. The VM Job views can be resized using the size toggle button, and the displayed VM clones can be filtered with the *Search* field.

If the scan allows VM interaction, click the VM Interact icon to interact with the scan. To stop an interactive scan, click the trash icon.



To take snapshots of scans or initiate interactions with the VM, your admin profile must have *Read/Write* privilege for *All On-Demand Scan Interactions*.

File Job

Go to *Scan Job > File Job* to search and view all files. You can apply search filters to drill down the information displayed. Filenames can also be searched based on name patterns, and a snapshot report can be created for all search results.

If the device is the primary node of a cluster, all jobs processed by the cluster are available to be searched. If the device is a worker node of a cluster, only jobs processed by this device are available to be searched.

The following options are available:

Refresh

Click the *Refresh* icon to refresh the entries displayed after applying search filters.



Search

- Click the plus symbol **+** to open the *Filterable Columns* list. The filters include *Detection, File Name, Rating, Malware, Source, Destination, Device, Email From, Email Subject, Email To, File MD5, File SHA1, File SHA256, File Type, Infected OS, Job ID, Job Status, Rated by, Scan Unit, Service, Submit User, Submit Filename* and *Suspicious Type*.
- Hover over a column heading to activate the filter icon. Click the icon to create a filter. The options will vary depending on the column.

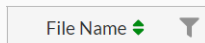



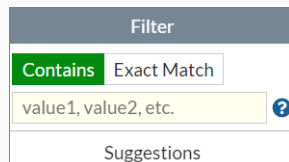





To create a filter, enter values or select values from the *Suggestions* list, click *Contains* or *Exact Match* and click *Apply*.



When filtering by *Rating, Malware, Device, File Type, Infected OS, Job Status, Rated By, Scan Unit, Service, Submit User* or *Suspicious Type*, suggested values as well as job counts will be displayed.

In the *Detection* column, you can use the date picker to choose the time period and apply a range that is equal to, greater or less than the time period.

Click *Resize to Contents* to close the filter.

<p>Job List</p>	<p>All the jobs that match your search criteria are displayed. Click the sort icon  to sort columns in ascending and descending order. The <i>File Name</i> column displays the following icons:</p> <ul style="list-style-type: none">  Rescan job  Archive file  Archived file  Video available <p>The <i>Rating</i> column displays the following icons:</p> <ul style="list-style-type: none">  Manual overwrite  Customized rating  FortiGuard Allowlist/Blocklist
<p>Export to Report</p>	<p>Select to open the <i>Report Generator</i> dialog box. Select to generate a PDF or CSV report. You can wait until the report is ready to view, or navigate away and find the report later in <i>Log & Report > Report Center</i> page.</p>
<p>Customize</p>	<p>Click the <i>Customize</i> icon to customize the <i>Job View</i> settings page. For more information, see Job View Settings on page 205.</p>
<p>Action</p>	<p>Click a job in the list to view more actions. The available actions are listed below.</p>
<p>View Details</p>	<p>Click the <i>View Details</i> to view file information. The information displayed in the view details page is dependent upon the file type and risk level.</p>
<p>Video</p>	<p>Click the <i>Video</i> button to play the video of the scan. Scan videos are available in On-Demand scans if the user has the privilege.</p>
<p>Perform Rescan</p>	<p>Click the icon to rescan the entry that is not rated by the dynamic scan.</p> <hr/> <div style="display: flex; align-items: center;">  <div> <p>The <i>Perform Rescan</i> icon is only available for malicious or suspicious jobs which are not rated by dynamic scan. In cluster mode, the icon is only available on the primary node.</p> <p>In the <i>Rescan Configuration</i> dialog, you can force the job to perform a Sandboxing scan.</p> <p>The rescan job will also be shown in <i>Scan Job > File On-Demand</i>.</p> </div> </div> <hr/>

The following information is displayed at the bottom right-hand corner of the page:

Display percentage	The percentage of jobs depending on your position in the page. The percentage increases as you scroll down the page.
Total Jobs	The number of file jobs available to view.

The displayed columns are determined by settings defined in *System > Job View Settings > File Detection Columns* page. For more information, see [Job View Settings on page 205](#).

URL Job

To view all URL scan jobs and search URLs, go to *Scan Job > URL Job*. You can apply search filters to drill down the information displayed. URLs can be searched based on different criteria, and a snapshot report can be created for all search results.





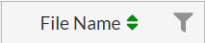
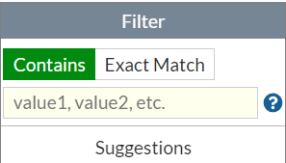



If the device is the primary node of a cluster, all jobs processed by the cluster are available to be searched. If the device is a worker node of a cluster, only jobs processed by this device are available to be searched.

The following options are available:

Refresh	<p>Click the refresh icon to refresh the entries displayed after applying search filters.</p> 
Search Field	<ul style="list-style-type: none"> Click the plus symbol + to open the <i>Filterable Columns</i> list. The filters include <i>Detection, URL, Rating, Submitted Filename, Submit User, Infected OS, Destination, Device, Email From, Email Subject, Email To, Job ID, Job Status, Rated by, Scan Unit, and Source</i>. Hover over a column heading to activate the filter icon. Click the icon to create a filter. The options will vary depending on the column.  <p>To create a filter, enter values or select values from the <i>Suggestions</i> list, click <i>Contains</i> or <i>Exact Match</i> and click <i>Apply</i>.</p>  <p>When filtering by <i>Rating, Device, Infected OS, Job Status, Rated By, Scan Unit, or Submit User</i>, suggested values along with job counts will be displayed.</p> <p>In the <i>Detection</i> column, you can use the date picker to choose the time period and apply a range that is equal to, greater or less than the time period.</p>

Click *Resize to Contents* to close the filter.

 Resize to Contents

<p>Job List</p>	<p>All the jobs that match your search criteria are displayed. Click the sort icon  to sort columns in ascending and descending order. The <i>URL</i> column displays the following icons:</p> <ul style="list-style-type: none">  Rescan job  File Downloading URL  File from downloading url  Video available <p>The <i>Rating</i> column displays the following icons:</p> <ul style="list-style-type: none">  Manual overwrite  Customized rating  FortiGuard Allowlist/Blocklist
<p>Export to Report</p>	<p>Select to open the <i>Report Generator</i> dialog box. Select to generate a PDF or CSV report. During generation, do not close the dialog box or navigate away from the page. You can wait until the report is ready to view, or navigate away and find the report later in <i>Log & Report > Report Center</i> page.</p>
<p>Customize</p>	<p>Click the <i>Customize</i> icon to customize the <i>Job View</i> settings page. For more information, see Job View Settings on page 205.</p>
<p>Action</p>	<p>Click a job in the list to view more actions. The available actions are listed below.</p>
<p>View Details</p>	<p>Click the <i>View Details</i> icon to view file information. The information displayed in the view details page is dependent on the file type and risk level.</p>
<p>Video</p>	<p>Click on the <i>Video</i> button to play the video of the scan job. Scan videos are available in On-Demand scans if user has the privilege.</p>
<p>Perform Rescan</p>	<p>Click the icon to rescan the suspicious or malicious entry that is not rated by the dynamic scan.</p>



The *Perform Rescan* icon is only available for malicious or suspicious jobs which are not rated by Dynamic Scan. In cluster mode, the icon is only available on the primary node.

The rescan job will also be shown in *Scan Job > URL On-Demand*.

In the *Rescan Configuration* dialog, you can customize the new scan's depth and timeout value. You can also force the URL to perform a Sandboxing scan.

The following information is displayed at the bottom right-hand corner of the page:

Display percentage	The percentage of jobs depending on your position in the page. The percentage increases as you scroll down the page.
Total Jobs	The number of file jobs available to view.

The displayed columns are determined by settings defined in *System > Job View Settings > URL Detection Columns* page. For more information, see [Job View Settings on page 205](#).

Overridden Verdicts

The *Overridden Verdicts* page displays jobs that users have manually marked as *False Positive* or *False Negative*. *Job IDs*, *Comment*, *Job Finish Time*, and the time that the user manually marked the verdict will be displayed. If the job's detailed information is still available, the user can click on *Job ID* to display them.

You can easily delete a FP/FN verdict in this page by selecting an entry and clicking the *Delete* button, or use CTRL+ click to select and delete multiple entries at the same time.

For information about overriding a verdict, see the *Mark as clean (false positive) / Mark as suspicious (false negative)* setting in [Appendix B- Job Details page reference on page 244](#)

File On-Demand

Go to *Scan Job > File On-Demand* to view on-demand files and submit new files to be sandboxed. Use File On-Demand to upload different file types directly to FortiSandbox. You can then view the results and decide whether to install the file on your network.





When a Suspicious or Malicious file is detected, except by dynamic scan, you can click the *ReScan* icon to rescan the file. This is useful when you want to understand the file's behavior when run on the Microsoft Windows host. You can force the file to do a sandboxing scan even if was detected in former steps of Static Scan, AV Scan, Cloud Query, or stopped from entering VM by sandboxing-prefilter settings. All rescanned jobs are listed on the *File On-Demand* page.

You can select VM types to do the sandboxing by overwriting what is defined in the *Scan Profile*. When you select MACOSX or WindowsCloud, the file is uploaded to the cloud to be scanned. For password protected archive files or Microsoft Office files, you should write down all possible passwords. The default password list in the *Scan Profile > Advanced* page is also used to extract the archive files.

All files submitted through the JSON API are treated as On-Demand files. Their results are also listed on this page.

File On-Demand page - level 1

The following options are available:

Submit File	<p>Click the button to submit a new file. You can upload a regular or archived file.</p> <p>Nested level of file compression is supported. All files in the archive will be treated as a single file.</p>
Show Rescan Job	Jobs generated from manual rescan can be shown/hidden by this option.
Search	Show the search filter field.
Add Search Filter	<p>Click  to add search filters. You can also directly type a partial file name to search all files that contain the specified name.</p> <p>Hover over the column heading to activate the filter icon to filter the column.</p> <div style="border: 1px solid #ccc; padding: 2px; width: fit-content; margin: 5px 0;"> File Name   </div> <p>When filtering by <i>Status</i> or <i>Submitted By</i>, suggested values as well as job counts will be displayed.</p>
Refresh	Click the <i>refresh</i> icon to refresh the entries displayed after applying search filters.
Export Data	Click the <i>Export Data</i> button to create a PDF or CSV snapshot report. You can wait until the report is ready to view, or navigate away and view the report later in <i>Log & Report > Report Center</i> .
View Jobs	<p>Click any record in the page, to activate the '<i>View Job Detail</i> icon below the row. Click the icon to view the scan job(s) associated with the entry.</p> <p>If the file is an archive file, all files inside it will be displayed in the level 2 page.</p>
Configure Table	<p>Hover your mouse over the header row to activate the <i>Configure Table</i>  icon at the left side of the header row. Click the icon to display the following options:</p> <ul style="list-style-type: none"> • <i>Best Fit Columns</i>: This displays the optimal size for each column. • <i>Remove All Filters</i>: This option is visible only when filters are applied. Click to clear all filters from the search bar. • <i>Reset Table</i>: Reset the File on-demand page settings back to default values.

This *File On-Demand* page displays the following information:

Submission Time	The date and time that the file was submitted to FortiSandbox. Use the arrows  to sort the entries in ascending or descending order.
Submitted Filename	The file name.
Submitted By	The name of the administrator that submitted the file. Use the column sorter to sort the entries in ascending or descending order.
Rating	Hover over the icon to view the file rating. The rating can be one or more of the following: <i>Clean</i> , <i>Low Risk</i> , <i>Medium Risk</i> , <i>High Risk</i> , <i>Malicious</i> , or <i>Other</i> . For archive files, the possible ratings of all files in the archive are displayed. During the file scan, the rating is displayed as <i>N/A</i> . If a scan times out or is terminated by the system, the file may have an <i>Unknown</i> rating.
Status	The scan status can be <i>In-Process</i> or <i>Done</i> .
File Count	The number of files associated with the entry. It is in the format of (finished file count)/(total files of this submission) when the scan is <i>In-Progress</i> . When the scan is done, it will display the total number of files in this submission.
Comments	The comments user enters when submitting the file.
Rescan Job	This icon indicates that this file is a rescanned version of another file.
Archive Submission	This icon indicates that an archived file has been submitted for scanning.



After a file is submitted, the file might not be visible immediately until the file, or any file, inside an archive file is put into a job queue. In a cluster setting, the file will not be visible until the file is put into a worker node's job queue.



To view the scan job(s) associated with the entry (Level - 2):

1. Click the *View Details* icon. The second level job page is displayed.



In this page you can view detailed information for files scanned. If the file is an archive file, all files in the archive are displayed in this page.

2. This page displays the following information and options:

Back	Click the <i>Back</i> button to return to the On-Demand page.
Search	Show or hide the search filter field.
Refresh	Click the <i>Refresh</i> icon to refresh the entries displayed after applying search filters.
Add Search Filter	Click  to add search filters. Click  at the right side of the search filter to remove the filter. You can also directly type a partial file name to search all files that contain the specified name.

Hover over the column heading to activate the filter icon to filter the column. When filtering by *Rating, Malware, Device, File Type, Infected OS, Job Status, Rated By, Scan Unit, Service, Submit User or Suspicious Type*, suggested values as well as job counts will be displayed.

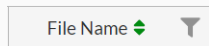

View Details

Click a record in the page to activate the *View Job Details* icon below the row. Click the icon to view file job detail information.

The *Job Details* page will be opened in a new tab. For information on the Job Details page, see [Appendix B- Job Details page reference on page 244](#).

Perform Rescan

You can rescan malicious or suspicious jobs if it was not rated by Dynamic Scan. In the rescanned job detail, you can click the original job ID to view the original file details.

Video

A video icon is displayed when *Record scan process in video* is selected at the time the scan is submitted. Click the icon to select one VM type in which the scan is performed and recorded. Select the VM type to play the video or save it to a local hard disk.

To create a snapshot report for all on-demand files:

1. Select a time period from the first dropdown list.
2. Select to apply search filters to further drill down the information in the report.
3. Click the *Export Data* button in the toolbar, opening the *Report Generator* window.
4. Select PDF or CSV.
5. Click the *Generate Report* button to create the report.
You can wait until the report is ready to view, or navigate away and find the report later in *Log & Report > Report Center*.
6. Click the *Close* icon or the *Cancel* button to quit the report generator.



The maximum number of events you can export to a PDF report is 1000. The maximum number of events you can export to a CSV report is 15000. Jobs over the limit are not included in the report.

To submit a file to FortiSandbox:

1. Click the *Submit File* button from the toolbar.
2. Configure the following options:

Select a File

Click the *Browse* button and locate the sample file or archived sample file on your management computer.

Comments

(Optional) Enter comments for future reference.

Advanced Options

Enable to configure passwords for encrypted files, and configure *Static Scan* and *Dynamic Scan* settings.

Password(s) for encrypted files

List all possible passwords to extract password protected archive file, or open password protected Microsoft Office/PDF file. One password per line. A maximum of 30 passwords is allowed. Default password list set in the *Scan Profile > Advanced tab* will also be used to extract the archive or Office/PDF files.

Only scan the following files inside

When submitting archive files, you can choose to scan only specific child files. This option applies only to archive files and is disabled by default.

Specified names or patterns

You can specify exact or partial file names, such as `calc.exe`, `contract`, or `pdf`. They can also use regular expressions to match specific patterns—for example, `\d+` will match files like `7123928343` or `111.jpg`. Multiple patterns can be entered, and the results will be combined. For instance, if a user inputs `jpg` and then `pdf`, all files with extensions like `.jpg`, `.JPG`, and `.pdf` will be scanned.



When you specify file names or patterns, only the matching files and their parent's archive will be scanned. The archive's file count will reflect only the matched results.

Static Scan**Skip result of**

Select one or more options to skip within the scan flow:. These include: *Statistic Scan*, *AV Scan* and *Community Cloud Query*.

Dynamic Scan**Force to scan**

Force to scan the file inside the VM.

Allow Interaction

Enable this option to interact with the Windows VM.

Dynamic Scan options**Follow VM Association Settings in Scan Profile**

If the sandboxing step is not skipped, the file will be sent to its associated VMs defined in the *Scan Profile*.

Force to Scan Inside the Following VMs	Overwrite VM association settings in the <i>Scan Profile</i> by selecting one or more of the enabled VMs.
Record a video	Select to enable video recording. After the scan finishes, a video icon will appear in the <i>File On-Demand</i> second level detail page. Click the icon to trigger a download or play the video.
Add to Malware Package	If the result matches malware package requirement, add scan result to threat package.
Submit multiple files	Support submit multiple files if toggle is enable, the popup window will not close after on submission.

3. Click the *Submit* button. A confirmation dialog box will be displayed. Click *OK* to continue. The file will be uploaded to FortiSandbox for inspection.
4. Click *Close* to exit.
The file will be listed in the *On-Demand* page. Once FortiSandbox has completed its analysis, you can select to view the file details.

To use the Allow Interaction feature:

1. Go to *Scan Job > File On-Demand* and click *Submit File* in the toolbar.
2. In the *Submit New File* window, enable *Force to scan the file inside VM* and check the *Allow Interaction* checkbox.
When selected, only one VM can be specified.
3. Click *Submit*.
4. Go to the *Scan Job > VM Jobs* . The job will be launched when a clone of a selected VM is available.

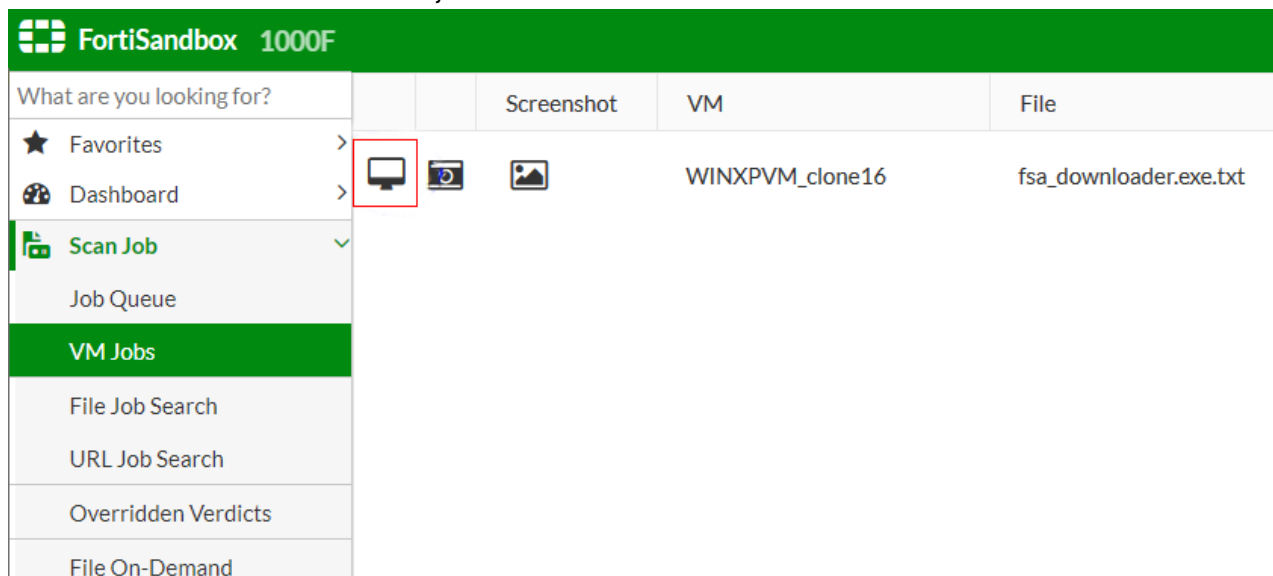

To interact with the windows VM:

1. Click the *Interaction* icon to use web based VNC client. Click *Yes* in the *Do you want to start the scan?* pop-up. The scan will start and the question becomes *Do you want to stop the scan?*

- Click Yes to stop the scan and the VNC session will close after a few seconds. Go back to the *On-Demand* page to check the scan result.



You have 30 minutes to finish the interaction. After that, the VNC session will be closed automatically.

The VNC remains active when you close the browser before the end of the 30 minutes. The VM resources are kept until they are cleaned up.



VM Interaction and Scan video recording features are only available to users whose admin profile has *Allow On-Demand Scan Interaction* enabled.

URL On-Demand

URL On-Demand allows you to upload a plain-text file containing a list of URLs, or an individual URL directly to your FortiSandbox device. Upon upload, the URLs inside the file, or the individual URL, is inspected. The *Depth* to which the URL is examined as well as the length of time that the URL is scanned can be set. You can then view the results and decide whether or not to allow access to the URL.

To view On-Demand URLs and submit URLs to scan, go to *Scan Job > URL On-Demand*. You can drill down the information displayed and apply search filters.

The following options are available:

Submit URL	Click the button to submit a file containing a list of scanned URLs, or submit an individual URL.
Show Rescan Job	Jobs generated from a customized rescan of a URL can be shown/hidden by this option.
Refresh	Click the <i>Refresh</i> icon to refresh the entries displayed after applying search filters.
Search	Show the search filter field.
Add Search Filter	<ul style="list-style-type: none"> Click the plus symbol + to open the <i>Filterable Columns</i> list. Hover over a column heading to activate the filter icon ▼. Click the icon to create a filter. The options will vary depending on the column. To create a filter, enter values or select values from the <i>Suggestions</i> list, click <i>Contains</i> or <i>Exact Match</i> and click <i>Apply</i>. <div data-bbox="600 1621 886 1785" data-label="Image"> </div> <p>When filtering by <i>Status</i> or <i>Submitted By</i>, suggested values as well as job counts will be displayed.</p>

In the *Submission Time* column, you can use the date picker to choose the time period and apply a range that is equal to, greater or less than the time period.

Click *Resize to Contents* to close the filter.

Export Data

Click the *Export Data* button to create a PDF or CSV snapshot report. The time period of included jobs in the report depends on the selection of Time Period filter. You can wait until the report is ready to view, or navigate away and find the report later in *Log & Report > Report Center*.

View Jobs

Click a row in the table to activate the *View Details* button to view the scan job(s) associated with the entry. Click the *Back* button to return to the on-demand page.

Configure Table

Hover over table header to activate the Configure Table icon . Click the icon to access the following options:



- *Best Fit Columns*: Displays the optimal size for each column.
- *Remove All Filters*: This option is visible only when filters are applied. Click it to clear all filters from the search bar.
- *Reset Table*: Reset the URL on-demand page settings back to default values.

This page displays the following information:

Submission Time	The date and time that the URL file or individual URL was submitted to FortiSandbox. Use the column filter to sort the entries in ascending or descending order.
Submitted Filename	The submitted URL file name. If the scan is about an individual URL, the name is scan_of_URL.
Submitted By	The name of the administrator that submitted the file scan.
Rating	<p>Hover over the icon in this column to view the rating. The rating can be one or more of the following: <i>Clean, Low Risk, Medium Risk, High Risk, Malicious, or Other</i>.</p> <p>During the URL scan, the rating is displayed as N/A. If a scan times out or is terminated by the system, the file will have an Other rating.</p>
Status	The scan status can be <i>Queued, In-Process, or Done</i> .
URL Count	The number of URLs associated with the submission when the scan is done. When the scan is <i>In-Progress</i> , it shows (finished scan)/(total URLs of this submission).
Comments	The comments a user entered when submitting the file scan.

To view the scan job(s) associated with the entry:

1. Select an entry in the table then click the *View Details* button to view the specific URLs that were scanned. The following options and information are displayed:

Back	Click the <i>Back</i> button to return to the On-Demand page.
Search	Show the search filter field.
Refresh	Click the <i>Refresh</i> icon to refresh the entries displayed after applying search filters.
Add Search Filter	<p>Click  to add search filters. Click  at the right side of the search filter to remove the filter. You can also directly type a partial file name to search all files that contain the specified name.</p> <p>When filtering by <i>Rating, Device, Infected OS, Job Status, Rated By, Scan Unit, or Submit User</i>, suggested values as well as job counts will be displayed.</p> <p>Hover over the column heading to activate the filter icon to filter the column.</p> <div style="border: 1px solid #ccc; padding: 2px; width: fit-content; margin: 5px 0;"> File Name  </div> <p>Click the <i>Close</i> to clear all search filters.</p>
View Job Detail	Select a record in the page to activate the <i>View Job Details</i> icon below the row. Click the icon to view file job detail information.
Perform Rescan	You can rescan malicious or suspicious jobs if it was not rated by Dynamic Scan. In the rescanned job detail, you can click the original job ID to view the original file details.
Scan Video	A video icon is displayed when <i>Record scan process in video</i> is selected at the time the scan is submitted. Click the icon to select one VM type in which the scan is performed and recorded. Select the VM type to play the video or save it to a local hard disk.



The columns displayed are determined by settings defined in System > Job View Settings > URL Detection Columns. For more information, see [Job View Settings on page 205](#).

2. Click the *View Job Detail* icon to view file details. The *View Job Detail* page will open a new tab. For information on the *View Job Detail* page, see [Appendix B- Job Details page reference on page 244](#).
3. Close the tab to exit the *View Job Detail* page.

To submit a file containing a list of URLs or an individual URL to FortiSandbox:

1. Click the *Submit URL* button from the toolbar. The *Submit New URL* window opens.
2. Enter the following information:

Depth

Enter the *Recursive Depth* in which URLs are examined. The original URL is considered level 0. A depth of 1 will open all links on the original URL page and crawl into them. The default value is define in the *Scan Policy and Object > Scan Profile* page.

Timeout	Enter the <i>Timeout Value</i> . The Timeout Value controls how long the device will scan the URL. If the network bandwidth is low, the timeout value should be larger to accommodate higher depth values. The default value is defined in the <i>Scan Policy and Object > Scan Profile</i> page.												
Direct URL	To scan only a single URL, check the <i>Direct URL</i> checkbox. Enter the URL in the <i>Enter a URL</i> field.												
Select a File	Click the <i>Browse</i> button and locate the plain-text file on your management computer. The maximum number of URLs in this file is determined <i>Maximum URL Value in Scan Policy and Object > Scan Profile > Advanced tab > URL content limit</i> .												
Comments	You can choose to enter optional comments for future reference.												
Advanced Options	<p>Toggle on to display the <i>Dynamic Scan</i> options. You have the option of following the <i>Scan Profile</i> settings or specifying the VMs.</p> <p>Dynamic Scan options:</p> <table border="1"> <tr> <td>Force to scan</td> <td>Enable this option to view the <i>Allow Interaction</i> settings</td> </tr> <tr> <td>Allow Interaction</td> <td>Enable this option to interact with the Windows VM. For more information, see To use the Allow Interaction Feature: on page 84.</td> </tr> <tr> <td>Follow VM Association settings in Scan Profile</td> <td>The URL will be sent to its associated VMs for the WEblink defined in the Scan Profile. Enabled VM means its clone number is larger than 0. Note: To use WindowsCloud VM, you need to purchase the subscription service. URL will be sent to Fortinet Sandboxing cloud to scan.</td> </tr> <tr> <td>Force to scan inside the following VMs</td> <td>A VM type must be selected. The <i>Scan Profile</i> settings will be overridden and the URL will only be scanned in selected VM types. If the VM images are not ready, the VM list will not be displayed.</td> </tr> <tr> <td>Record a video</td> <td>Select to enable video recording. After the scan is finished, a video icon will show in the second level detail page. Click the icon to trigger a download or play the video.</td> </tr> <tr> <td>Add to URL Package</td> <td>Select to add the sample to malware package, if the result meets settings in Package Options</td> </tr> </table>	Force to scan	Enable this option to view the <i>Allow Interaction</i> settings	Allow Interaction	Enable this option to interact with the Windows VM. For more information, see To use the Allow Interaction Feature: on page 84 .	Follow VM Association settings in Scan Profile	The URL will be sent to its associated VMs for the WEblink defined in the Scan Profile. Enabled VM means its clone number is larger than 0. Note: To use WindowsCloud VM, you need to purchase the subscription service. URL will be sent to Fortinet Sandboxing cloud to scan.	Force to scan inside the following VMs	A VM type must be selected. The <i>Scan Profile</i> settings will be overridden and the URL will only be scanned in selected VM types. If the VM images are not ready, the VM list will not be displayed.	Record a video	Select to enable video recording. After the scan is finished, a video icon will show in the second level detail page. Click the icon to trigger a download or play the video.	Add to URL Package	Select to add the sample to malware package, if the result meets settings in Package Options
Force to scan	Enable this option to view the <i>Allow Interaction</i> settings												
Allow Interaction	Enable this option to interact with the Windows VM. For more information, see To use the Allow Interaction Feature: on page 84 .												
Follow VM Association settings in Scan Profile	The URL will be sent to its associated VMs for the WEblink defined in the Scan Profile. Enabled VM means its clone number is larger than 0. Note: To use WindowsCloud VM, you need to purchase the subscription service. URL will be sent to Fortinet Sandboxing cloud to scan.												
Force to scan inside the following VMs	A VM type must be selected. The <i>Scan Profile</i> settings will be overridden and the URL will only be scanned in selected VM types. If the VM images are not ready, the VM list will not be displayed.												
Record a video	Select to enable video recording. After the scan is finished, a video icon will show in the second level detail page. Click the icon to trigger a download or play the video.												
Add to URL Package	Select to add the sample to malware package, if the result meets settings in Package Options												
Submit multiple files	Enable to submit multiple files. The pop-up window will not close after submission.												

3. Click *Submit*.

To use the Allow Interaction Feature:

1. Go to *Scan Job > URL On-Demand* and click *Submit URL* from the toolbar.
2. In the *Submit New URL* window, check the *Allow Interaction* checkbox.
When selected, only one VM can be specified.
3. Click *Submit*.
4. Go to the *Scan Job > VM Jobs* page. The job will be launched when a clone of a selected VM is available.

To interact with the Windows VM:

1. Click the *Interaction* icon to use web based VNC client.
2. Click *Yes* in the *Do you want to start the scan?* popup, the scan will start and the question becomes *Do you want to stop the scan?*
Click *Yes* to stop the scan and VNC session will be closed. Go back to *On-Demand* page to check the scan result.



You have 30 minutes to finish the interaction. After that, the VNC session will be closed automatically.

The VNC remains active when you close the browser before the end of the 30 minutes. The VM resources are kept until they are cleaned up.



VM Interaction and Scan video recording features are only available to users whose admin profile has *Allow On-Demand Scan Interaction* enabled.

Cloud storage

FortiSandbox can scan files stored on cloud, and currently supports AWS S3, Azure File Share, Azure Blob Storage, Google Cloud Storage, Microsoft OneDrive and Microsoft SharePoint. Go to *Security Fabric > Network Share* to view and configure cloud storage access information.

Cloud Storage scans can be scheduled or run on-demand, and connectivity to the cloud storage can be tested.

The following options are available:

Create New	Click to create a new cloud storage connection.
Edit	Select an entry from the list and then click <i>Edit</i> in the toolbar to edit the entry selected.
Delete	Select an entry from the list and then click <i>Delete</i> in the toolbar to remove the entry selected.
Scan Now	Select an entry from the list and then click <i>Scan Now</i> in the toolbar to schedule an immediate scan for the selected entry.

Scan Details	Select an entry from the list and then click <i>Scan Details</i> in the toolbar to view the scheduled scan entries.
Test Connection	Test the selected entry's connection. The result is displayed in the banner at the bottom right corner.

The following information is displayed:

Name	The name of the cloud storage.
Scan Scheduled	The scan scheduled status. Scheduled network scans are done in parallel.
Type	The mount type.
Share Path	The cloud storage access URI.
Quarantine	Displays if quarantine is enabled.
Enabled	Displays if the cloud storage scan is enabled. If a cloud storage scan is disabled, its scheduled scan will not be executed.
Status	Displays the cloud storage connection status. Click <i>Test Connection</i> to show the connection status (AWS S3, Azure Blob Storage, Google Cloud Storage, Microsoft One Drive, Microsoft SharePoint and SFTP).

To create a new cloud storage scan:

1. Go to *Security Fabric > Network Share*.
2. Click the *Create New* button from the toolbar.
3. Configure the following options:

Enabled	Select to enable network share configuration. If network share is not enabled, its scheduled scan will not run.
Network Share Name	Enter the network share name.
Mount Type	Select the mount type from the dropdown list. Depending on the type selected, you will be asked for different information required to access your cloud storage. The following options are for cloud storage: <ul style="list-style-type: none"> • AWS S3 Settings • Azure FS Settings • Azure Blob Storage • Google Cloud Storage • Microsoft OneDrive • Microsoft SharePoint
Scan Files Of Specified Pattern	Select to include or exclude files which match a file name pattern.
File Name Pattern	Enter the file name pattern.

Scan Job Priority	When multiple network share scans run at the same time, the higher priority scans will get more scan power compared to those having lower priority. The priority can be set to <i>High</i> , <i>Medium</i> (default), or <i>Low</i> .
Keep A Copy Of Original File On FortiSandbox	Select to keep a copy of the original file on FortiSandbox.
Skip Sandboxing for the same unchanged files	Select to skip Sandboxing scan on existing files (if applicable) and only Sandboxing scan new files. Existing files will only be scanned by Antivirus engine and Community Cloud query. This is to improve scan speed.
Enable Quarantine of Malicious Files	Select to enable quarantine then select the quarantine location from the dropdown list. Files with a Malicious rating will be quarantined in the quarantine location. Quarantined file is placed inside a folder with the name of the Job ID. Inside the folder each quarantined file is renamed with the corresponding Job ID for that particular file and a meta file with more information.
Enable Quarantine of Suspicious - High Risk Files	Select to enable quarantine of <i>Suspicious High Risk</i> files, then select the quarantine location from the dropdown list. Files with a High Risk rating will be quarantined in the quarantine location. Quarantined file is placed inside a folder with the name of the Job ID. Inside the folder each quarantined file is renamed with the corresponding Job ID for that particular file and a meta file with more information.
Enable Quarantine of Suspicious - Medium Risk Files	Select to enable quarantine of <i>Suspicious Medium Risk</i> files, then select the quarantine location from the dropdown list. Files with a Medium Risk rating will be quarantined in the quarantine location. Quarantined file is placed inside a folder with the name of the Job ID. Inside the folder each quarantined file is renamed with the corresponding Job ID for that particular file and a meta file with more information.
Enable Quarantine of Suspicious - Low Risk Files	Select to enable quarantine of <i>Suspicious Low Risk</i> files, then select the quarantine location from the dropdown list. Files with a Low Risk rating will be quarantined in the quarantine location. Quarantined file is placed inside a folder with the name of the Job ID. Inside the folder each quarantined file is renamed with the corresponding Job ID for that particular file and a meta file with more information.
Enable Quarantine of Other rating files	Select to enable quarantine of <i>Other Rating</i> files, then select the quarantine location from the dropdown list. Files with a Other rating, which means the scan was not completed for some reason, will be quarantined in the quarantine location.

	Quarantined file is placed inside a folder with the name of the Job ID. Inside the folder each quarantined file is renamed with the corresponding Job ID for that particular file and a meta file with more information.
Enable moving clean files to a sanitized location	Select to move Clean rating files to another location. By default, a new folder is created for each scheduled scan job in the sanitized location and all clean files are copied under it with the original folder structure. To save storage size, the user can un-check <i>Keep a complete copy of clean files for every scheduled scan</i> , then files of the same path will have only one copy saved in the sanitized location.
Enable Scheduled Scan	Select to enable scheduled scan. Select the schedule type from the dropdown list. Select the minute or hour from the second dropdown list.
Description	Enter an optional description for the network share entry.



When a file is moved, to leave a copy in its original location, go to the *Quarantine* edit page to enable *Leave a File At Source Location* and select *A Copy of Original File*.

4. Select *OK* to save the entry.

To run a network share scan immediately:

1. Go to *Security Fabric > Network Share*.
2. Select a share.
3. Click the *Scan Now* button to run the scan immediately.

To test network share connectivity:

1. Go to *Security Fabric > Network Share*.
2. Select a share.
3. Click *Test Connection* to test connectivity with the network share.

AWS S3 Settings

FortiSandbox can scan files stored on cloud using AWS S3.

The following AWS S3 settings are available when creating a new Network Share, Quarantine, and Job Archive:

AWS S3 Bucket Name	Enter the bucket name, found in the AWS management console in the <i>S3 Service</i> page.
S3 Bucket Folder Path	Enter the folder's path, starting with <i>/</i> .

AWS IAM Access Key ID	Enter the access key ID. To find the key ID, go to the AWS management console, click on the username in the top-right of the page, then click the <i>Security Credentials</i> link to generate the access key ID.
Secret Access Key	Enter the secret key matching the access key ID. The secret access key is displayed when you generate the access key ID.
Confirm Secret Access Key	Confirm the secret access key.

Azure File System

FortiSandbox can scan files stored on cloud using Azure File System.

Azure File Share

The following Azure file share settings are available when creating a new Network Share, Quarantine, and Job Archive:

Domain of the Share URL	Enter the Azure File Share URL's domain, found on the Azure Portal > Storage Accounts > click the storage account name for FortiSandbox > click <i>Data Storage: File Shares</i> > click the File Share for FortiSandbox > <i>Share URL</i> > copy the domain of the Share URL
Path of the Share URL	Enter the path of the Share URL, found on the <i>Azure Portal</i> > <i>Storage Accounts</i> > click the storage account name for FortiSandbox > click <i>Data Storage: File Shares</i> > click the <i>File Share</i> for FortiSandbox > click <u>Browse</u> > Share path starting with <i>/</i> .
Name of the Storage Account	Enter the name of the storage account, found on the <i>Azure Portal</i> > <i>Storage Accounts</i> > copy the <i>Storage Account</i> name.
Access Key of the Account	Enter the access key of the account, found on the <i>Azure Portal</i> > <i>Storage Accounts</i> > click the <i>Storage Account</i> name for FortiSandbox > click <i>Security + networking: Access keys</i> > copy the <i>Access Key</i> .
Confirm Access Key	Confirm the access key.

Azure Blob Storage

Set up the container for FSA on Azure

1. Log into the Azure Portal and go to the *Storage Account* for FortiSandbox.
2. In left menu, click *Containers* then click the + *Container* icon to create a new container:

For *Public access level*, you can select either *Blob* or *Container*.

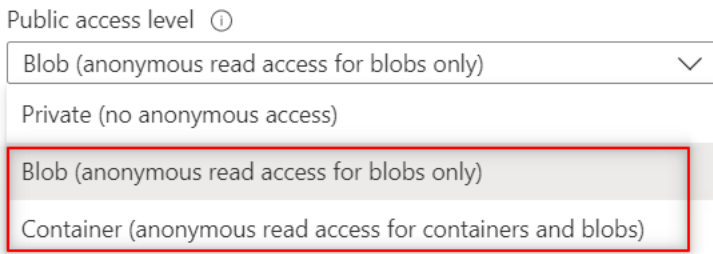

3. Go to *Access policy* > *Add policy* and locate the to the newly created container.
4. Under *Permissions* select *Read* and *Write* permissions, then click *Save*.

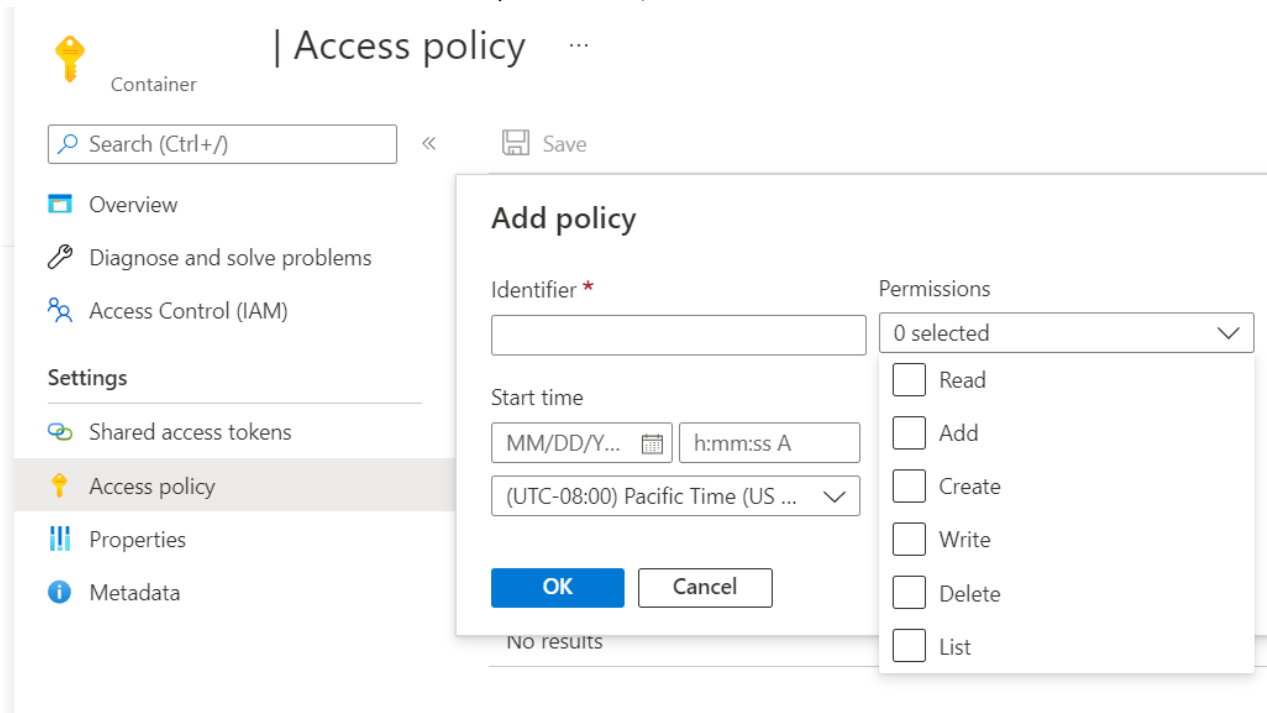

Setup the Azure Blob Storage on FSA

1. On FortiSandbox go to Security Fabric > Network Share.
2. The following *Azure Blob Storage* settings are available when creating a new *Network Share*, *Quarantine*, and *Job Archive*:

Mount Type	Select <i>Azure Blob Storage</i> .
Container Name	Enter the container name.
Blob folder path	Currently only <i>/</i> is accepted as the path.
Name of the Storage Account	Enter the name of the Storage Account.
Access Key of the Account	Enter the Access Key of the Storage Account.
Confirm Access key	Confirm the access key.

Configuration examples

Network Share configuration

FSA only supports to scan Azure Files/Blob (which shared by SMB) on the Storage Account. Not support to scan Azure Disk on the Storage Account.

<input checked="" type="checkbox"/> Enabled	
Mount Type:	Azure Blob Storage ▼
Network Share Name:	<input type="text"/>
Container Name	<input type="text"/>
<small>IP address or fully-qualified domain name</small>	
Blob folder path	/ <input type="text"/>
<small>In the format of /path1/path2</small>	
Scan Files of Specified Pattern:	<input checked="" type="radio"/> Include <input type="radio"/> Exclude
File Name Pattern:	*.* <input type="text"/>
<small>File names patterns in comma separated regular expressions format, Put "*" for all files</small>	
Name of the Storage Account	<input type="text"/>
Access Key of the Account	<input type="text"/>
Confirm Access key	<input type="text"/>
<small>Enter the same password as above, for verification</small>	

Quarantine configuration

FSA only supports to scan Azure Files/Blob (which shared by SMB) on the Storage Account. Not support to scan Azure Disk on the Storage Account.

<input checked="" type="checkbox"/> Enabled	
Quarantine Name:	<input type="text"/>
Mount Type:	Azure Blob Storage ▼
Container Name	<input type="text"/>
<small>IP address or fully-qualified domain name</small>	
Blob folder path	/ <input type="text"/>
<small>In the format of /path1/path2</small>	
Name of the Storage Account	<input type="text"/>
Access Key of the Account	<input type="text"/>
Confirm Access key	<input type="text"/>
<small>Enter the same password as above, for verification</small>	
<input checked="" type="checkbox"/> Leave a File At Source Location	
	<input checked="" type="radio"/> A Copy of Original File <input type="radio"/> A Placeholder File Showing File is Quarantined
Description:	<input type="text"/>

Job Archive configuration

Archive Location
FSA only supports to scan Azure Files/Blob (which shared by SMB) on the Storage Account. Not support to scan Azure Disk on the Storage Account.

Enabled

Mount Type:

Container Name
IP address or fully-qualified domain name

Blob folder path
In the format of /path1/path2

Name of the Storage Account

Access Key of the Account

Confirm Access key
Enter the same password as above, for verification

Google Cloud

This topic guides you through the process of setting up a Google Cloud bucket and creating a Network Share in FortiSandbox. This topic assumes you have knowledge and experience with cloud applications. For detailed information about creating buckets in Google Cloud, please see the product documentation

Set up a Google Cloud bucket

To set up a Google Cloud bucket:

1. Log in to your Google Cloud account
2. Go to the [Google Console](#), and select a resource.

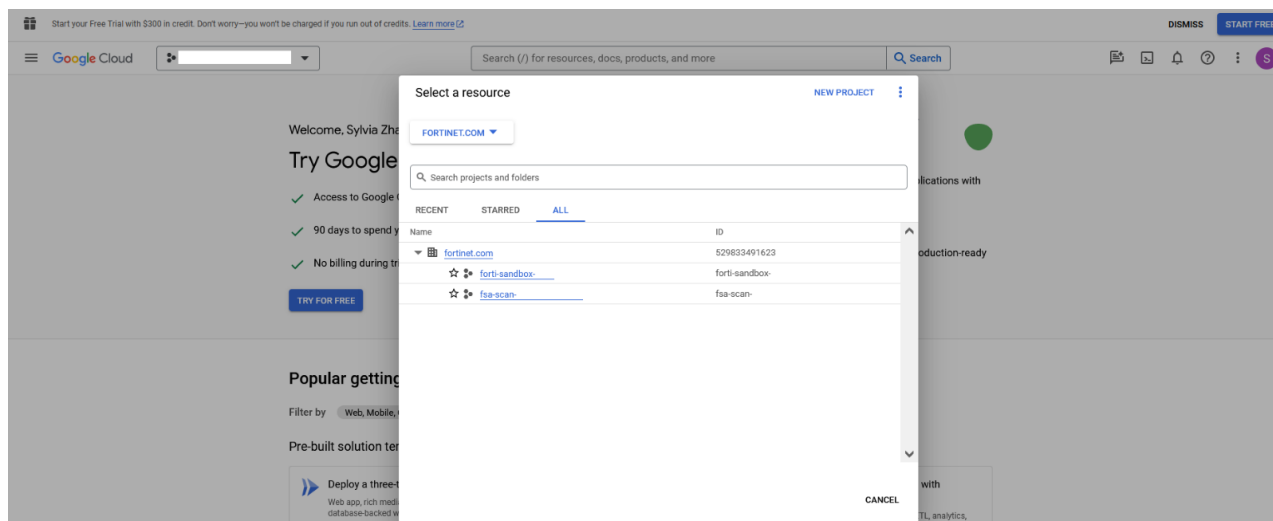

3. Create or access the project.
If the project is already created within your organization, you need to request for the *editor role access* from the administrator. Otherwise, click *New Project* to start a new project.
4. Navigate to the correct project.
5. Create a service account.
 - a. Go to *IAM & Admin > Service Accounts* and click *+ CREATE SERVICE ACCOUNT*.

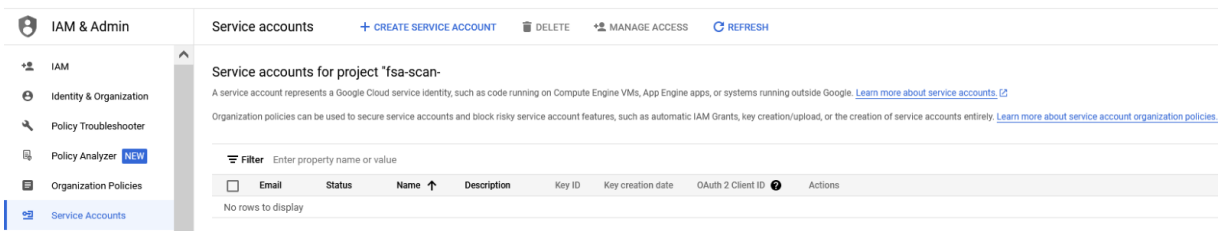

- b. Configure the *Service account details* and then click *CREATE AND CONTINUE*.

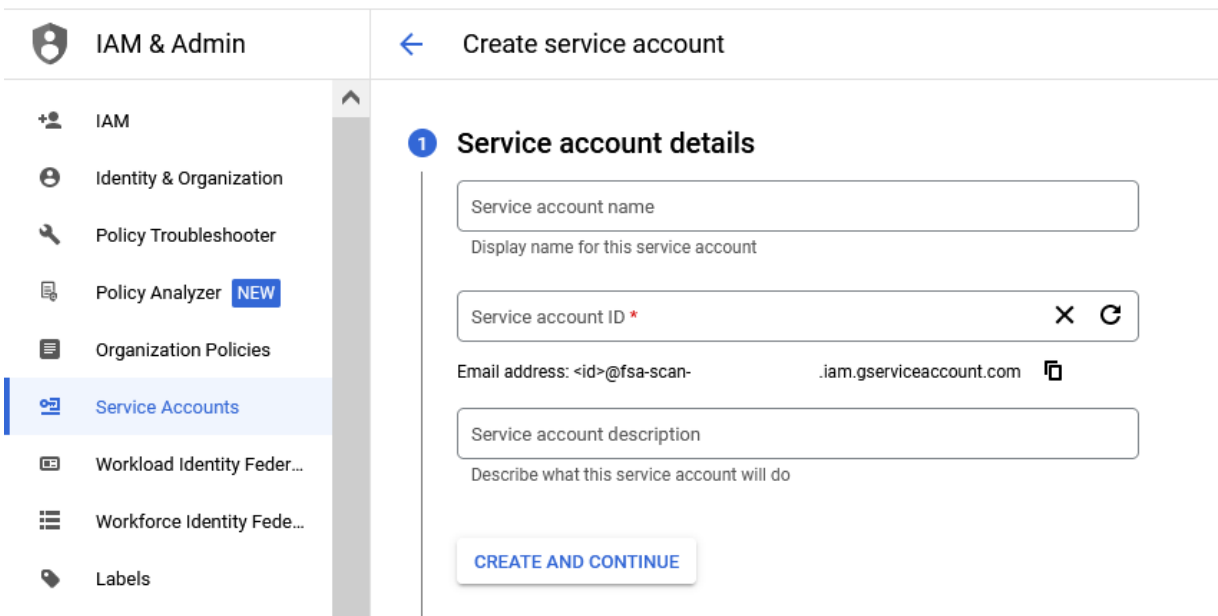

Service account name	The display name for this service account
Service account ID	Google Cloud Console will auto-fill the service account ID when naming the Service account.
Service account description	The description of this service account.



- c. Grant the following roles to this service account to access your project, and then click *CONTINUE*.
 - Storage Admin
 - Storage Object Admin

2 Grant this service account access to project (optional)

Grant this service account access to fsa-scan-991031-szhao01 so that it has permission to complete specific actions on the resources in your project. [Learn more](#)

<p>Role</p> <p>Storage Admin</p> <p>Grants full control of buckets and objects.</p>	<p>IAM condition (optional) ?</p> <p>+ ADD IAM CONDITION</p>	
<p>Role</p> <p>Storage Object Admin</p> <p>Grants full control over objects, including listing, creating, viewing, and deleting objects.</p>	<p>IAM condition (optional) ?</p> <p>+ ADD IAM CONDITION</p>	



+ ADD ANOTHER ROLE

CONTINUE

d. (Optional) Grant users access to this service account and then click DONE to complete the update.

3 Grant users access to this service account (optional)

Grant access to users or groups that need to perform actions as this service account. [Learn more](#)

<p>Service account users role</p> <p>Grant users the permissions to deploy jobs and VMs with this service account</p>	
<p>Service account admins role</p> <p>Grant users the permission to administer this service account</p>	

DONE CANCEL

6. Add an access key for this service account

a. Navigate to *Manage Keys*. Choose the Service account and go to *Actions > Manage keys* .

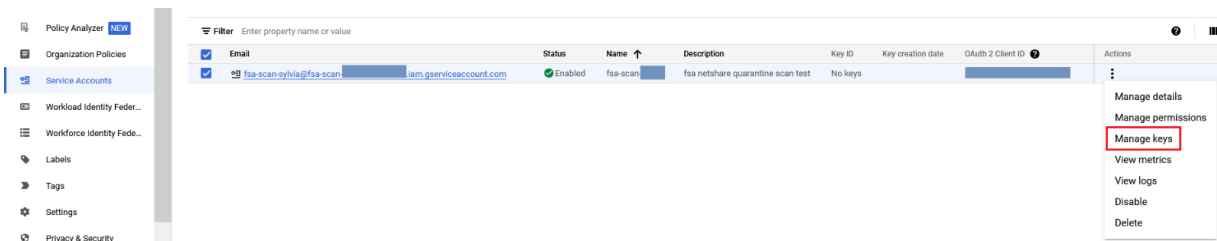

b. Create new key: Click *Add Key > Create New Key* .

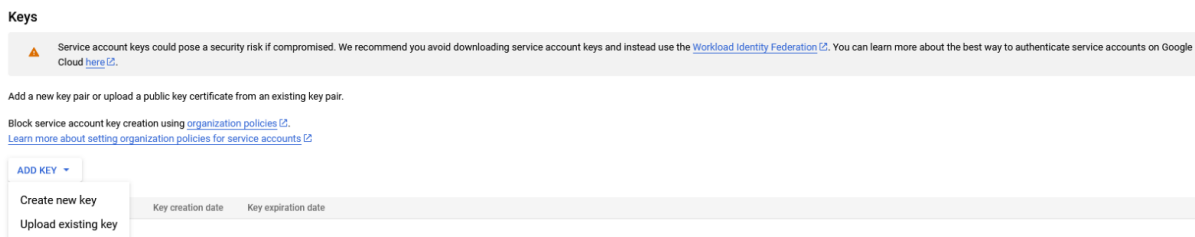

c. Complete the new key creation: Click *Key type > JSON* and click *CREATE* to create the new key.

Create private key for "fsa-scan-sylvia"

Downloads a file that contains the private key. Store the file securely because this key can't be recovered if lost.

Key type

- JSON
Recommended
- P12
For backward compatibility with code using the P12 format

CANCEL CREATE

d. Save the key. The private key will save to your computer automatically

7. Confirm the access permissions assigned to the service account. Go to *IAM* and ensure the access permissions are assigned to the service account.

IAM & Admin

- IAM**
- Identity & Organization
- Policy Troubleshooter
- Policy Analyzer **NEW**
- Organization Policies
- Service Accounts
- Workload Identity Feder...
- Workforce Identity Fede...
- Labels
- Tags
- Settings
- Privacy & Security
- Identity-Aware Proxy
- Roles
- Audit Logs
- Manage Resources

IAM

PERMISSIONS RECOMMENDATIONS HISTORY

Beginning on April 29th, 2024 at-scale policy analysis and advanced IAM recommendation capabilities will require Security Command Center Premium. [Learn more](#)

Permissions for project "fsa-scan-"

These permissions affect this project and all of its resources. [Learn more](#)

VIEW BY PRINCIPALS VIEW BY ROLES

GRANT ACCESS REMOVE ACCESS

Filter Enter property name or value

Type	Principal ↑	Name	Role	Security insights ⓘ
Person	cfan@fortinet.com	Conner Fan	Editor	
Service Account	fsa-scan-sylvia@fsa-scan-991031-szhao01.iam.gserviceaccount.com	fsa-scan-	Storage Admin Storage Object Admin	
Person			Editor	
Person			Editor	
Person	michaelliu@fortinet.com	Michael Liu	Editor	
Service Account			Owner	
Person			Owner	

8. Create a bucket: Navigate to *Cloud Storage* and click *CREATE* to start creating the bucket.

Cloud Storage Buckets **CREATE** REFRESH

Buckets Filter Filter buckets

9. Configure the bucket and click *CREATE*.

Name your bucket	Pick a globally unique, permanent name by following Google Naming guidelines
Choose where to store your data	This defines the geographic placement of your data and affects cost, performance, and availability. This cannot be changed later
Choose a storage class for your data	Choose a storage class depends on your requirements
Choose how to control access to objects	Choose the restrictions of data access depending on your requirements
Choose how to protect object data	Your data is always protected with Cloud Storage, but you can also choose from these additional data protection options to add extra layers of security if needed

The other configuration of quarantine, see [Quarantine on page 60](#).

Create Google Cloud Network Share and Quarantine on FortiSandbox

To import a Google Cloud Network Share Key:

1. Go to *System > Networkshare Keys*.
2. Click *Import*, to import the private key.

Import Networkshare Key

Mount Type: Google Cloud Storage ▼

Upload Networkshare Key File
Maximum 64 KBs

Access key name:
May contain letters, numbers and .- characters only, maximum 64 characters.

Description:

OK Cancel

3. Go to *Security Fabric > Network Share* and click *Create New*.

New Network Share

Enabled

Mount Type: Google Cloud Stor. ▼

Network Share Name:
May contain letters, numbers and _ only.

Bucket Name:
IP address or fully-qualified domain name

Bucket Folder Path:
In the format of /path1/path2

Scan Files of Specified Pattern: Include Exclude

File Name Pattern:
File names patterns in comma separated regular expressions format. Put ** for all files

Service account key name: szhao01.VALID_ke ▼ [Click here to import Networkshare Key](#)

4. Configure the Network share details:

Mount Type	Choose <i>Google Cloud Storage</i> .
Bucket Name	The bucket name for FortiSandbox network share scan.
Bucket Folder Path	The folder path for FortiSandbox network share scan.
Service account key name	Choose the imported private key.

To create a Google Cloud Storage Quarantine

1. Go to *Security Fabric > Quarantine* and click *Create New*.
2. Configure the Quarantine details:

Mount Type	Choose <i>Google Cloud Storage</i> .
Bucket Name	The bucket name for FortiSandbox quarantine.
Bucket Folder Path	The folder path for FortiSandbox quarantine.
Service account key name	Choose the imported private key.

The other configuration of quarantine, see [Network Share on page 55](#).

Microsoft OneDrive

This topic describes how to set up a MS One Drive account in Azure and create a Network Share and Quarantine for the account in FortiSandbox. This topic assumes you have experience and knowledge with Microsoft OneDrive. For more information about Microsoft OneDrive see the product documentation.

Set up MS OneDrive account

1. Log into the Azure Portal: <https://azure.microsoft.com/en-us/get-started/azure-portal>
2. To create a new App registration, go to *Microsoft Entra ID > Manage > App registrations > New registration*.

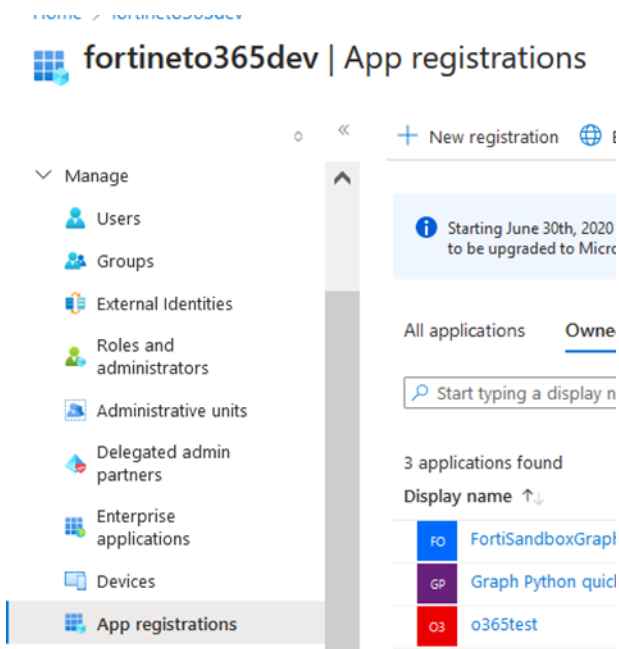

3. Register the application.

Name	Enter a display name
-------------	----------------------

Supported account types

Accounts in this organizational directory only (<Your organization> - Single Tenant)

Register an application ...*** Name**

The user-facing display name for this application (this can be changed later).

Supported account types

Who can use this application or access this API?

- Accounts in this organizational directory only (fortineto365dev only - Single tenant)
- Accounts in any organizational directory (Any Microsoft Entra ID tenant - Multitenant)
- Accounts in any organizational directory (Any Microsoft Entra ID tenant - Multitenant) and personal Microsoft accounts (e.g. Skype, Xbox)
- Personal Microsoft accounts only

[Help me choose...](#)**Redirect URI (optional)**

We'll return the authentication response to this URI after successfully authenticating the user. Providing this now is optional and it can be changed later, but a value is required for most authentication scenarios.

 Register an app you're working on here. Integrate gallery apps and other apps from outside your organization by adding from [Enterprise applications](#).By proceeding, you agree to the [Microsoft Platform Policies](#) **Register**

4. To create a new client secret, go to the App you just registered and click *Manage > Certificates & secrets > New client secret*.

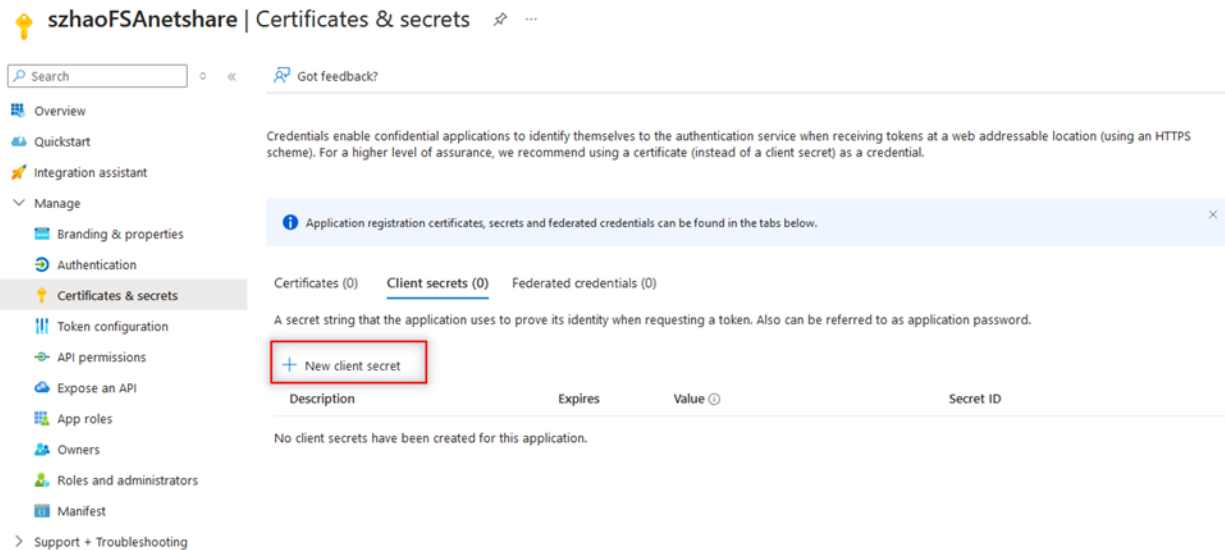

5. To add API permissions go to *Manage > API Permissions* and select *Microsoft Graph* and then add permissions one-by-one.
The following API permissions are required:

Application permissions

1. Apply *Files* to the filter and then choose:
 - *Files.Read.All* (Read files in all site collections)
 - *Files.ReadWrite.All* (Read and write files in all site collections)
2. Click *Add permissions*.
3. Apply *User* to the filter and then choose:
 - *User.Read.All* (Read all users' full profiles)
4. Click *Add permissions*.



Files.Read.All, Files.ReadWrite.All, and User.Read.All are application type permissions. They must be granted by an admin.

Delegated permission

1. Apply *User* to the filter and then choose:
 - *User.Read* (Sign in and read user profile)
2. Click *Add permissions*.

API / Permissions name	Type	Description	Admin consent required	Status
▼ Microsoft Graph (4) ...				
Files.Read.All	Application	Read files in all site collections	Yes	✔ Granted for fortineto365... ***
Files.ReadWrite.All	Application	Read and write files in all site collections	Yes	✔ Granted for fortineto365... ***
User.Read	Delegated	Sign in and read user profile	No	✔ Granted for fortineto365... ***
User.Read.All	Application	Read all users' full profiles	Yes	✔ Granted for fortineto365... ***

- To grant the principal account as *Members* User Type, go to *Microsoft Entra ID > Manage > Users*.



Please be aware that FortiSandbox can only scan OneDrive folders of the *Members* of this tenant. For users categorized as *Guest* for their user type, FortiSandbox cannot scan files within their OneDrive folders.

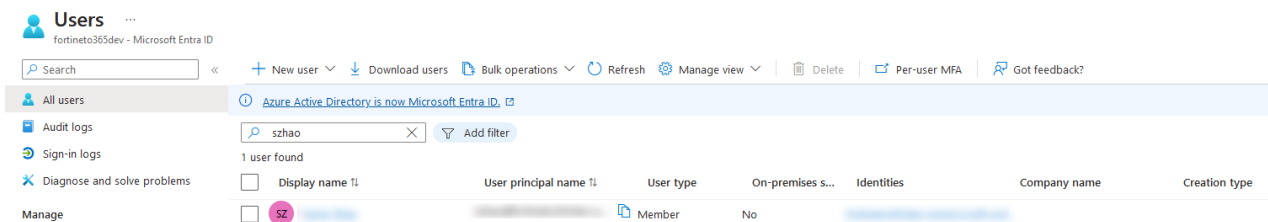

- To manage files via MS OneDrive, login into the portal: <https://onedrive.live.com/login/>.

Create MS OneDrive Network Share and Quarantine on FortiSandbox

To create a MS OneDrive Network Share:

- Go to *Security Fabric > Network Share* and click *Create New*.
- Configure the Network share details:

Mount Type	Choose <i>MS OneDrive</i> .
User Principal Name	The principal account for FortiSandbox Network Share scan.
Tenant ID	The App registration's tenant ID for FortiSandbox Network Share scan.
MS OneDrive Folder Path	The folder path for FortiSandbox Network Share scan.
Client ID	The App registration's client ID for FortiSandbox Network Share scan
Client Secret	The secret of App registration for FortiSandbox Network Share scan.

The other configurations, see [Network Share on page 55](#).

To create a MS OneDrive Quarantine:

- Go to *Security Fabric > Quarantine* and click *Create New*.
- Configure the Network share details:

Mount Type	Choose <i>MS OneDrive</i> .
User Principal Name	The principal account for FortiSandbox quarantine
Tenant ID	The App registration's tenant ID for FortiSandbox quarantine.
MS OneDrive Folder Path	The folder path for FortiSandbox quarantine.
Client ID	The App registration's client ID for FortiSandbox quarantine

Client Secret

The secret of App registration for FortiSandbox quarantine.

The other configurations, see [Quarantine on page 60](#).

Microsoft SharePoint

This topic explains how to set up Microsoft SharePoint and create a Network Share and Quarantine in FortiSandbox. It assumes you have prior experience and knowledge of Microsoft SharePoint. For more information about Microsoft SharePoint, please refer to the product documentation.

Set up Microsoft SharePoint

To set up Microsoft SharePoint

1. Log into the Azure Portal: <https://azure.microsoft.com/en-us/get-started/azure-portal>
2. To create a new App registration, go to *Microsoft Entra ID > Manage > App registrations > New registration*.

fortineto365dev | App registrations

+ New registration

Starting June 30th, 202 to be upgraded to Mic

All applications Own

Start typing a display

1 applications found

Display name ↑↓

SZ szhaoFSAnetshare

App registrations

3. Register the application.

Name	Enter a display name.
Supported account types	Accounts in this organizational directory only (<Your organization> - Single Tenant)

4. To create a new client secret, go to the App you just registered and click *Manage > Certificates & secrets > New client secret*.
5. To add API permissions, go to *Manage > API Permissions* and select *Microsoft Graph* and then add the *Application permissions* one-by-one. The following API permissions are required:
- Sites.FullControl.All*
 - Sites.Manage.All*
 - Sites.Read.All*
 - Sites.ReadWrite.All*

Sites.Selected

Microsoft Graph (6)				
Sites.FullControl.All	Application	Have full control of all site collections	Yes	Granted for fortinet0365_...
Sites.Manage.All	Application	Create, edit, and delete items and lists in all site collections	Yes	Granted for fortinet0365_...
Sites.Read.All	Application	Read items in all site collections	Yes	Granted for fortinet0365_...
Sites.ReadWrite.All	Application	Read and write items in all site collections	Yes	Granted for fortinet0365_...
Sites.Selected	Application	Access selected site collections	Yes	Granted for fortinet0365_...

- To manage documents via Microsoft Share Point, we recommend signing into SharePoint from your Team Site URL.

Copy the SharePoint site URL (e.g., <https://yourorganizationname.sharepoint.com/sites/project-x>).

- Replace *yourorganizationname* with your organization's domain name.
- Replace *project-x* with your organization's actual site name.

Create a Network Share and Quarantine

To create a Microsoft SharePoint Network Share:

- Go to *Security Fabric > Network Share* and click *Create New*.
- Configure the Network share:

Mount Type	Select <i>MS SharePoint</i> .
SharePoint Host Domain	The SharePoint Host Domain for FortiSandbox Network Share scan.
SharePoint Site Name	The SharePoint Site Name for FortiSandbox Network Share scan.
SharePoint Drive Name	The SharePoint Drive Name for FortiSandbox Network Share scan.
SharePoint Path	The SharePoint Path for FortiSandbox Network Share scan.
Tenant ID	The App registration's tenant ID for FortiSandbox Network Share scan.
Client ID	The App registration's client ID for FortiSandbox Network Share scan.
Client Secret	The secret of App registration for FortiSandbox Network Share scan

For the other configuration settings, see [Network Share on page 55](#).

To create a Microsoft SharePoint Quarantine:

- Go to *Security Fabric > Quarantine* and click *Create New*.
- Configure the Quarantine details:

Mount Type	Select <i>MS SharePoint</i> .
SharePoint Host Domain	The SharePoint Host Domain for FortiSandbox Quarantine.
SharePoint Site Name	The SharePoint Site Name for FortiSandbox Quarantine.
SharePoint Drive Name	The SharePoint Drive Name for FortiSandbox Quarantine.
SharePoint Path	The SharePoint Path for FortiSandbox Quarantine.
Tenant ID	The App registration's tenant ID for FortiSandbox Quarantine.

Client ID	The App registration's client ID for FortiSandbox Quarantine.
Client Secret	The secret of App registration for FortiSandbox Quarantine

For the other configuration settings, see [Quarantine on page 60](#).

Scan Policy and Object

Scan Profile

Use the *Scan Profile* page to do the following:

- Configure the types of files that are put into the job queue.
- Configure the VM image to scan pre-defined file types and user defined file types.
- Configure enhanced scan options, cloud service, scan timeout and other scan flow related options.

File types

The following table displays the default file types FortiSandbox can detect and scan in the VM:

Executables	<p>BAT, CMD, DLL, EXE, JAR, JSE, MSI, PS1, SCR, UPX, VBE, WSF, and VBS.</p> <p>Most DLL files cannot be executed within a VM. You can enable pre-filtering with the following CLI command:</p> <pre>sandboxing-prefilter -e -tdll</pre> <p>Only the DLL files which can be executed inside a VM are put into the Job Queue.</p>
Archives	<p>7Z, ACE, ARJ, BZ2, CAB, GZ, ISO, KGB, LZH, PST, RAR, TAR, TGZ, UDF, VHD, XZ, Z, and ZIP.</p> <p>Extraction is limited by the following conditions:</p> <ul style="list-style-type: none">• Number of child files to extract. Default is 1000 and is configurable by prescan-config• Total file size of child files to extract, configurable by filesize-limit• Time spent to extract child files. Default timeout value is 15s for regular files(<=512M) and 600s for large files (>512M), the value is configurable by prescan-config
	<p> Not all file types will be scanned in the VM. For example, only ZIP files are scanned, whereas other archive files such as TGZ and CAB are detected but are not scanned.</p>
Microsoft Office	<p>Microsoft Word: DOC, DOCM, DOCX, DOT, DOTM, DOTX</p> <p>Microsoft Excel: CSV, XLS, XLAM, XLSB, XLSM, XLSX, XLT, XLTM, XLTX</p> <p>Microsoft PowerPoint: POT, POTM, POTX, PPT, PPTM, PPTX, PPAM, PPS, PPSM, PPSX, SLDM, SLDX, THMX</p> <p>Microsoft Publisher: PUB</p> <p>Microsoft OneNote: ONE</p>

	Microsoft Web Query Files: IQY Rich Text Format: RTF Microsoft Outlook: EML, ICS, MSG
Adobe	PDF
Flash	SWF
Static Web Files	HTML, JS, LNK, and URL.
Android File	APK
MACOSX Files	Mac (MACH_O, FATMACH, XAR, and APP files) and dmg (DMG) files.
WEBLink	URLs submitted by FortiMail devices or sniffed from email body by sniffer.
Linux	ELF , OBJ, and SH



You can create a custom file type and associate it to an existing VM. Therefore, file type analysis is not limited to just the file types listed in the table above.

Sometimes input sources send .eml files to FortiSandbox. For example, FortiMail sends .eml files to FortiSandbox when the .eml file is attached inside an email. FortiSandbox parses the .eml file to extract its attachments and perform file scans.

When `sandboxing-embeddedurl` is enabled, the top three URLs inside the email body are extracted and scanned along with the .eml inside the same VM. If the URL is a direct download link, the file is downloaded and sent with the URL to be scanned.

This feature is useful when you want to scan older emails when they are loaded to FortiSandbox, such as through an On-Demand scan or Network Share scan.



By default, FortiMail holds a mail item for a time to wait for the FortiSandbox verdict. Before FortiSandbox scans a file or URL sent from FortiMail, it checks if FortiMail still needs the verdict as FortiMail might have already released the email after time out. If not, FortiSandbox gives the job an *Unknown* rating and skipped status.

Use the CLI command `fortimail-expired` to enable or disable this expiration check.



To use remote VMs including MACOSX and Windows Cloud VM, you need to purchase subscription service from Fortinet. Files are uploaded to Fortinet Sandboxing cloud to scan according to *Scan Profile* settings.

Scan Profile Pre-Filter Tab

Use the Pre-Filter feature to define file types and URLs that are allowed to enter the job queue so that only suspicious files or unrated URLs are forwarded for Dynamic Scan. The files and URLs will still go through the Static Scan stage. Enabling the Pre-Filter can improve the scan performance. For more information, see [Improving Scan Performance](#) in the FortiSandbox *Best Practices and Troubleshooting Guide*.

To allow a file type to enter the job queue:

Click the toggle button to enable it. If the button is grayed out, files of that type are dropped.



Selected processing file type applies to submission via sniffer, adapters and Fabric devices (except FortiMail). Files from OnDemand, FortiMail and Network Share are always processed.

To enable pre-filter for selected file types:

Click the toggle button of the file types and URLs to enable pre-filter accordingly. If the button is enabled, only suspicious files or unrated URLs are forwarded for Dynamic Scan.

To use trust results from trusted resources during pre-filter:

Click the toggle button to enable it. If the button is enabled, files rated by that resources are pre-filtered.

When *FortiNDR entrust* is enabled, files rated by FortiNDR as clean skip the sandboxing VM scan step.

When *Trusted Vendor* is enabled, executable files from a small internal list of trusted vendors skip the sandboxing scan step.

When *Trust Domain* is enabled, files downloaded from a small internal list of trusted domains skip the sandboxing scan step.

Trusted domains:

- <http://www.google.com>
- <http://www.microsoft.com>

Trusted vendors:

- Microsoft
- Fortinet Technologies
- Adobe Systems
- Google
- Apple



If there is a long queue of pending jobs, consider turning off some file types to the job queue. For example, in most networks, many files are static web files (JavaScript, html, aspx files) and Adobe Flash files. When you have performance issue, consider turning them off.

If a file type is turned off, files of that type already in the job queue will still be processed. You can use the `pending-jobs` command or *Scan Job > Job Queue* page to purge them.



To determine the number of each file type and its input source, use the `pending-jobs` command or the *Scan Job > Job Queue* page.

Using URL Pre-Filtering with Scan Profile and Web Categories

By default, URL scanning is done inside a VM. However, if performance is a concern, you can enable *URL Pre-Filtering*.

When URL Pre-Filtering is enabled, it works with the [Scan Profile](#) settings and [Web Category](#) settings to create the job and rate the URL.

When	Then
The category or URL is Unrated	The URL will be scanned inside the VM.
The URL category is defined in the <i>Web Category</i> page but is not checked as <i>Benign</i>	A job is created and the URL will be rated as <i>Suspicious (Low Risk, Medium Risk or High Risk)</i> according to the category).
The URs category is defined in the <i>Web Category</i> page, but is checked as <i>Benign</i>	A job is created and the URL will be rated as <i>Clean</i> and will not be scanned inside the VM.

Scan Profile VM Association Tab

The *VM Association* tab defines file type and VM type association. Association means files of a certain file type are sandboxed by the associated VM type. This page displays all in-use VM image(s) and associated file types. For standalone units, the VM clone number is also displayed.

When you click the VM type, the panel expands to show the *Selected Browser* and *Installed Applications* for this VM type.

To edit an associated file type:

Click the *Edit* icon. The *Select File Types* pane opens from the ride side of the page showing all the available file types.

File types are grouped into different categories. You can select an individual file type or click *All* to select all the file types in the category.



The *url*, *htm*, and *lnk* file types in the *Web pages* group are for the file types containing shortcuts of a web link, while the *WEblink* type in the *URL detection* group is for URL addresses. The *WEblink* type follows the depth and timeout settings in the *Advanced* tab.



There might be malicious URLs, including direct download links, inside Office files and PDF files. You can scan selected URLs along with the original file inside files' associated VM. To turn on this feature, use the `sandboxing-embeddedur1` CLI command. For more information, see the [FortiSandbox CLI Reference Guide](#).

Add a user defined extension:

Before you begin, click the *Pre-Filter* tab, under *Process the following selected file types*, to make sure *User defined* is enabled.

1. In the *Select File Types* pane, scroll to the bottom and click the + sign and enter a new extension.
2. Click the green check mark, then associate the extension to the selected VM.
3. Click *OK*.



When a user defined extension is associated with a VM, files with the user defined extension will be scanned by the VM regardless of its real file type. Only a file's extension counts. To meet the criteria for user defined extension, files must possess the exact extension that is specified.

Finalizing the list of Scanned File Types:

After you have finished the association configuration, click *Apply* to apply the changes. Files will then be scanned by the associated VM images if they meet the entry conditions for VM scan.



For a file to be scanned in the VM image:

- Its file type has to be associated with a VM image.
 - The VM image has a non-zero clone number (i.e. it is enabled).
 - The file is not rated by another rating mechanism, (eg, static scan, allow/block list) prior to Sandboxing scan.
 - The file is not filtered out from the Sandboxing scan. For more information, see the [sandboxing-prefilter](#) command in the for [FortiSandbox CLI Reference guide](#).
-

If sandboxing pre-filtering is *OFF* for a file type, it will be scanned by each associated VM type. If sandboxing pre-filtering is *ON*, files of this file type will be statically scanned first by an advanced analytic engine and only suspicious files will be scanned by the associated VM type. Other files go through all scan steps except the Sandboxing scan step.

To improve the system scan performance, you can turn on the sandbox pre-filtering for a file type with the `sandboxing-prefilter` CLI command. For example, you can associate web files to VM types. If the sandboxing pre-filtering is *OFF* for `js/html` files, all of them will be scanned inside associated VM types. This may use up the system's sandboxing scan capacity because web files are usually large in amount. It is recommended to enable sandboxing pre-filtering for web files. For more details, refer to the [FortiSandbox CLI Reference Guide](#).



For a predefined file extension, FortiSandbox will autodetect the file extension.
For user-defined file extension, the file must possess the exact extension.

HA cluster

In an HA cluster environment, *Scan Profile* can only be configured on the primary node then synchronized to all worker nodes.

The primary node will collect all enabled VM image information. It is highly recommended that all cluster nodes have the same in-use VM, although it is not enforced. If cluster nodes do not have the same list of enabled VM types, a warning message appears at the top of the *Scan Profile* page. If a unique VM image is only installed on a worker node, you can still configure in the primary node and the result will be synchronized to that worker node.

Scan Profile Advanced Tab

Use the *Advanced* tab to define advanced features for file/URL detection.

Scan Enhancements

Adaptive Scan

Enable this option to dynamically adjust the number of clones of enabled local VMs. Local VMs include default VMs, optional VMs, and customized VMs.

Enabling this option does not affect the number of remote MacOS or Windows Cloud VMs. However, the total VM clone number cannot exceed licensed clone count.

In an HA cluster, only the primary node can enable this option, and the setting is immediately synced to all nodes.

A VM's clone number is increased when its usage is higher than a threshold and there are assignable clones or reassignable clones.

A VM's clone number is reduced when it has reassignable clones and there are other VMs requiring more clones.

An enabled local VM has at least one clone. The number of assignable clones cannot be less than 0 at any time.



FortiSandbox-Ali, FortiSandbox-AWS, FortiSandbox-Azure, FortiSandbox-GCP, and FortiSandbox-HyperV do not support Adaptive Scan.

Force dynamic scan on AV/Static detections

When enabled, files rated by AV or Static scan will be forced to scan in associated VMs to get more indicators.

Parallel VM Scan

Enable this option to allow FortiSandbox to run multiple VMs at the same time for a job. Normally, a job is scanned in the VM in sequence if the file type is associated with a different VM.

The parallel VM scan only happens when a job needs two or more VM scans and those VMs have a free clone. If there are no free clones, then parallel VM scan does not occur.

In an HA cluster, only the primary node can enable this option, and the setting is immediately synced to all nodes.

Pipeline Mode

Enable this option to improve performance and accelerate the scan by reducing the time spent on VM instance starts and shutdowns. This means that jobs can be scanned in a VM instance one at a time without shutting down the instance.

A guest VM instance can only be reused when the scanning job will not change the VM instance status. If the guest VM status has been changed, the VM instance will be shut down and restored for the next job.

If a job is rated *malicious* or *suspicious* in a pipeline mode VM instance, the job is rescanned in a fresh restored VM to secure a final rating.

When a file is scanned in Pipeline Mode VM clone, the *Job Details* overview page will indicate the launched pipeline mode clone, (for example, *Pipeline mode OS:WIN7X86VM*).

If *debug* level log is enabled, *Job Event* will show the number of jobs scanned in the Pipeline Mode VM clone, (for example, *WIN7X86VM_clone065 is in pipeline and has scanned 2 jobs*). See, [Logging Levels](#).

Pipeline mode VM clones can scan files and URLs. However, on-demand jobs will not use pipeline mode VM clones. In addition, executable files from any source will not use pipeline mode VM clones.



FortiSandbox-AWS , FortiSandbox-Azure and Fortinet-GCP do not support Pipeline Mode.

VM Scan Ratio

Enable this option to allow a customized ratio for jobs that are scanned in the VM. The ratio is a low bound for the jobs that need to be scanned, meaning the percentage of jobs scanned in the VM can be equal to or higher than the preset ratio.

This option:

- Is an extra filter that sends a job to the VM. When disabled, the VM scan is skipped.
- Does not affect jobs that should normally be scanned in the VM. Those jobs are still VM scanned.

Rescan of completed jobs

AV signature updates are frequent (every hour). Running an AV rescan against finished jobs of the last 24 hours could hinder performance. You have the option to disable the AV Rescan to improve performance.

Cloud Services

Community Cloud Query



Cloud Query is enabled by default. Disable the Cloud Query in the following scenarios:

- You have an enclosed environment. Disabling the Cloud Query will improve the scan speed.
- You receive an incorrect verdict from the Cloud Query and before Fortinet fixes it, you can turn it off temporarily.

Cloud Rating Service

Enable this option to enhance the rating of the submission to provide a better detection rate by utilizing the Rating Engine and supervised Machine Learning in the cloud. When enabled, the local verdict and rating log are sent to the cloud. The originally submitted file is not included.

Real-Time Zero-Day Anti-Phishing Service	<p>Enable this option to allow FortiSandbox to use this subscription-based service to scan URLs for phishing and spam in real-time. See, Real-Time Zero-Day Anti-Phishing Service.</p> <p>This option can also be enabled by running the following CLI command: <code>anti-phishing</code>. For more information, see the FortiSandbox CLI Reference Guide.</p>
Limits and Timeouts	
URL depth limit	<p>Enable this option to examine the recursive depth of URLs (from 1 to 5). When this option is disabled, only the URL itself is examined.</p>
URL count to be extracted from email body	<p>Enable this option to extract URLs from the email body of .eml or .msg files across all input sources. This option is disabled by default, so no URLs will be extracted from the email body in any input source. When enabled, you can specify a range from 1 to 10. Once configured, .eml or .msg files received from any input source will automatically extract embedded URLs up to the defined limit as a WEBLINK job.</p>
URL content limit	<p>Enable this option to specify the maximum number of URLs from 1 to 10000. When this option is disabled, the maximum number of URLs is unlimited.</p>
VM Scan timeout for executable file	<p>FortiSandbox supports a customized timeout value to control the tracer running time for executable files in the VM. If a zip file is sent to the VM while it has executable children, it will use this timeout value as well.</p> <p>The accepted value is between 60 to 180 seconds. The default value is 180 seconds.</p>
VM Scan timeout for documents and other non-executable files	<p>FortiSandbox supports a customized timeout value to control the tracer running time in the VM. A shorter value provides better performance and faster scan speed, but lower accuracy. For a balance of speed and accuracy, use a value that falls in the middle of the 60-180 second range for a standard model. Higher-end models (2000E/3000E/3000F/1500G/3000G), allows 45-180 second range. The default value for all models is 60 seconds.</p> <p>Currently, MAC OSX and Windows Cloud VM do not support file detection timeout.</p>
VM Scan timeout for URL	<p>When URL detection is enabled, FortiSandbox scans URLs (WEBLinks). You can also specify the timeout setting (from 30 to 1200 seconds). When this option is disabled, the default timeout is 60 seconds.</p>
Additional Options	
Default Password-protected archive files	<p>Define a list of passwords that can be tried to extract archive files. Input passwords line by line. A maximum of 30 passwords is allowed.</p>

	<p>When upgrading FortiSandbox:</p>  <p>If the Scan Profile contains more than 30 archive passwords at the time of upgrade, the passwords will continue to work. However, if you save any changes to the Scan Profile, the system will prompt you to limit the archive to 30 passwords.</p>
<p>Default Password-protected PDF/Office files</p>	<p>Define a list of passwords to attempt decryption of PDF/Office files. Input one password per line. A maximum of 30 passwords is allowed.</p>
<p>Reject duplicate files from Security Fabric Device</p>	<p>When FortiSandbox receives a duplicate file from the same or different fabric device, it will return the existing verdict without scanning it again.</p>
<p>Content Disarm and Reconstruction</p>	<p>Enable Content Disarm and Reconstruction (CDR) to allow users to automatically sanitize PDF and Office documents by removing potentially malicious content—such as scripts, macros, embedded objects, and hyperlinks—and optionally insert a cover page indicating the file has been processed.</p>
	<p> This feature is only available for files submitted via API and ICAP to a standalone or primary node in a cluster. When enabled, the API or ICAP client will receive a disarmed copy, optionally with a cover page. The original file will still be scanned by FortiSandbox. For implementation details, refer to the API Guide or ICAP adapter on page 44.</p> <hr/> <p>If you need to download the original file, it can be accessed via the following URL: <code>https://<FSAIP or ClusterIP>/ng/cdr_download?file=<original file sha256></code></p> <p>To configure the retention period for original files in FortiSandbox as well as the downloaded package password, go to <i>System > Setting > Data Storage and Download of Original file package</i>.</p> <p>CDR is disabled by default.</p>
<p>Feedback Options</p>	
<p>Contribute detected suspicious files to FortiSandbox Community Cloud</p>	<p>Enable to upload malicious and suspicious file and URL information to the Sandbox Community Cloud. When enabled, the original file or URL, its checksum, tracer log, verdict, submitting device's serial number, and the downloading URL will be uploaded. The maximum file size you can upload to Sandbox Community Cloud is 200MB.</p>
<p>Contribute detected suspicious URL to FortiGuard</p>	<p>Enable this option to submit the malware downloading URL to the FortiGuard Web Filter Service.</p>
<p>Upload detection statistics to FortiGuard</p>	<p>Enable this option to upload statistics to FortiGuard. When enabled, the following are uploaded: submitting device's serial number and firmware, job-related results and statistics.</p>

To enhance the VM scan ratio:

Enable *Set customized sandboxing ratio* and set a ratio between 1 and 100.

In the system log, FortiSandbox generates a debug-level job event log every 5 minutes, providing VM scan ratio statistics for jobs from approximately the past hour. This allows you to see how many files were scanned by the VM during that time.

VM scan ratio calculation

The ratio is recalculated for each job based on all completed jobs from one hour prior to the current job's submission time.

Example 1:

The preset ratio is 60%, there are 100 total jobs in the last hour before the current job, and 60 of 100 have been sent to VM scan. The ratio before the current job is $60 \times 100.0 / 100 = 60\%$ ($\leq 60\%$). So, the current job will be sent to the VM.

Example 2:

You submit another job after the example above. The scan ratio is $(60+1) \times 100.0 / (100+1) = 60.39\%$ ($> 60\%$). So, this job will not be sent to the VM.

Since VM scans take longer and jobs may be rated by other methods (e.g., cache, AV, allowlist/blocklist, static scan), the VM scan job ratio over the past hour may differ from the configured setting.

In an HA cluster, only the primary node can enable this option, and the setting is immediately synced to all nodes. Each node uses its local scan jobs to calculate the latest VM scan ratio, and then compare the universal ratio to decide whether to send a current job to VM.



The *Dynamic Scan* or *VM Scan* timeout is the maximum runtime of the VM. The VM Scan may shorten the duration when the file or URL finish execution.

Real-Time Zero-Day Anti-Phishing Service

To configure the server settings:

Go to *System > FortiGuard*. For information, see [FortiGuard on page 192](#).

To troubleshoot the Real-Time Zero-Day Anti-Phishing Service:

Use the CLI command `diagnose-debug anti-phishing` to troubleshoot the following issues:

- Server connection status
- Server return rating result
- Downloading screen shots

For more information, see the [FortiSandbox CLI Reference Guide](#).

File Scan Priority

Files of different file types and input sources have different processing priority. Priority means, under the same situation, files in the high priority queue will have a higher chance of being processed first. This means if a VM image is configured to scan two different job queues, the job queue with high priority will be scanned first and only when this queue is empty will the low priority job queue be processed. Therefore, it is recommended that different job queues are associated with different VM image(s). In this release, job queue priority can be adjusted in the *Scan Policy and Object > Job Queue Priority* page. By default, the job queue priority is:

Files from On-Demand/RPC
sniffer/device submitted executable files and Linux files
user defined file types
sniffer/device submitted Office files
sniffer/device submitted PDF files
sniffer/device submitted Android files sniffer/device submitted MacOS files
URLs of all sources
device submitted Adobe flash/web files
sniffer submitted Adobe flash/web files
Adapter submitted files
Network share submitted files

File Scan Flow

After a file is received from an input source, it goes through the following steps before a verdict is reached. If a verdict can be reached at any step, the scan stops.

1. Filtering and Static Scan

In this step, the file is scanned by the Antivirus engine and the YARA rules engine. Its file type is compared with the *Scan Profile page > Pre-Filter* tab settings to decide if it should be put in the job queue. If yes, it is compared with the allowlist and blacklist and overridden verdict list.

For certain file types, such as Office and PDF files, they are scanned statistically in virtual engines to detect suspicious contents. If they contain embedded URLs, the URLs are checked to see if the website is a malicious website.

2. Community Cloud Query

The file will be queried against the Community Cloud Server to check if an existing verdict is available. If yes, the verdict and behavior information are downloaded. This makes the malware information shareable amongst the FortiSandbox Community for fast detection.

3. Sandboxing Scan

If the file type is associated with a VM type, as defined in the *Scan Profile page > VM Association*, the file is scanned inside a clone of that VM type. A file that is supposed to be scanned inside a VM might skip this step if it's filtered out by sandboxing prefiltering. For more information, see the *FortiSandbox CLI Guide* for the sandboxing-prefilter command.

URL Scan Flow

After a URL is received from an input source, it goes through the following steps before a verdict is reached. If a verdict can be reached at any step, the scan stops.

1. Static Scan.

In this step, the URL is checked against the user uploaded *Allowlist* or *Blocklist* and the *Overridden Verdicts* list.

2. Sandboxing Scan.

If WEblink is associated with a VM type as defined in the *Scan Profile page > VM Association* tab, the URL is scanned inside a clone of that VM type. If the *URL* type is enabled with the *sandboxing-prefilter* command, only URLs whose webfiltering category is *UNRATED* is scanned inside a VM.

For more information, see the *sandboxing-prefilter* command in the *FortiSandbox CLI Guide*.



In the Static Scan step, URLs are checked against the user uploaded allowlist and blocklist in this order and rated as *Clean* or *Malicious*: *Domain black list > URL REGEX black list > URL black list > Domain white list > URL REGEX white list > URL white list*. For example, if users enter **.microsoft.com* in the domain allowlist and *http://www.microsoft.com/*.abc/bad.html* in the URL blocklist, URL *http://www.microsoft.com/1abc/bad.html* is rated as *Malicious*.

VM Settings

The all-in-one Universal VM streamlines the *VM Settings* page. You can select any VM type, download pre-defined VMs, upload your own custom VM, and expand to the cloud remotely. Additionally, the clone count limit applies to all enabled VM types. Any existing add-on licenses for upgrades and custom VM types are automatically gathered and converted to Universal VM.

VM images are grouped into the following types:

- [Default VMs on page 117](#)
- [Optional VMs on page 118](#)
- [Custom VMs on page 120](#)
- [Remote \(Cloud\) VMs on page 121](#)
- [Simulator VMs on page 121](#)

To configure VM settings:

- Go to *Scan Policy and Object > VM Settings* to view installed and available VM images and configure the number of instances of each image.

Please refer to the guidelines below when configuring your VM.



Before you install multiple VM images:

Installing VM images consumes a substantial amount of disk space. When installing multiple VM images, keep in mind this will increase the consumption of disk space. This reduces the available disk space for processing and storing Job records as configured on your data retention.

VM types

Default VMs

Default VMs are a basic set of images installed on FortiSandbox by default.

The following software is installed on each pre-installed Windows guest image:

- Adobe Flash Player
- Adobe Reader
- Java Run Time
- MSVC Run Time
- Microsoft .Net Framework
- Microsoft Office:
 - In 2021: Excel, Teams, OneDrive, OneNote, Outlook, PowerPoint, Project, Publisher, Visio and Word.
 - In 2019: Excel, OneDrive, OneNote, Outlook/, PowerPoint, and Word.
- Web Browsers

Model, License, and VM Information

Model	Base License*	Default VMs	Number of VM Hosts Supported
FSA-3000G	Windows10 (2021 Edition) Windows 11 Office 2021	***WIN10LTSCO21V1 (with Office)	Supports 8 VM hosts by default, maximum up to 150 local VM hosts. For Cloud expansion, you can subscribe up to 200 Windows Cloud VMs.
FSA-3000F	Windows 7 Windows 10 Office 2019	WIN10X64VMO19F (with Office) or WIN10LTSCO19V1 (with Office)	Supports 8 VM hosts by default, maximum up to 74 VM hosts. For Cloud expansion, you can subscribe up to 200 Windows Cloud VMs.
FSA-3000E	Windows 7 Windows 8.1 Windows 10 Office 2016	WIN7X86VM (with Office) WIN7X64VM	Supports 8 VM hosts by default, maximum up to 56 VM hosts. For Cloud expansion, you can subscribe up to 200 Windows Cloud VMs.
FSA-2000E	Windows 7 Windows 8.1 Windows 10 Office 2016	WIN7X86SP1016 (with Office)	Supports 4 VM hosts by default, maximum up to 24 VM hosts. For Cloud expansion, you can subscribe up to 200 Windows Cloud VMs.
FSA-1500G	Windows 10(2021 Edition) Windows 11 Office 2021	***WIN10LTSCO21V1 (with Office)	Supports 2 VM hosts by default, maximum up to 28 VM hosts. For Cloud expansion, you can subscribe up to 200 Windows Cloud VMs.

Model	Base License*	Default VMs	Number of VM Hosts Supported
FSA-1000F/DC	Windows 7 Windows 10 Office	WIN7X64SP1O16Z (with Office)	Supports 2 VM hosts by default, maximum up to 14 VM hosts. For Cloud expansion, you can subscribe up to 200 Windows Cloud VMs.
FSA-500G	Windows 10(2021 Edition) Windows 11 Office 2021	***WIN10LTSCO21V1 (with Office)	Supports 2 VM hosts by default, maximum up to 14 VM hosts. For Cloud expansion, you can subscribe up to 200 Windows Cloud VMs.
FSA-500F	Windows 7 Windows 10 Office	WIN7X64SP1O16Z (with Office)	Supports 2 VM hosts by default, maximum up to 6 VM hosts. For Cloud expansion, you can subscribe up to 200 Windows Cloud VMs.
FSA-VM00	None	WIN7X86SP1O16 (with Office**) WIN10LTSCO21V1(with Office) (available for download**)	No VM host by default, maximum up to 8 VM hosts. For Cloud expansion, you can subscribe up to 200 Windows Cloud VMs.
FSA-VMS	None	WIN10LTSCO21V1 (with Office)	No VM host by default, maximum up to 64 VM hosts. For Cloud expansion, you can subscribe up to 200 Windows Cloud VMs.

*Licenses pre-installed on the appliance.

**The FSA-VM00 and FSA-VMS models do not come with a pre-installed default VM. To download and install a VM from the image server, go to Tools > Add VMs from FortiGuard.

***Due to a higher VM resource requirement, the new WIN10LTSCO21V1 and WIN10LTSCO19V1 Optional VM, requires conversion of the file system from EXT3 to EXT4 on certain models, such as FSA-500F and FSA-1000F, when these VMs are enabled the first time. The conversion may take hours depending on the current content of the system.

The number of supported VM hosts for each model is only for images published by Fortinet. This number might be lower for custom images with high resource requirements.

Optional VMs

The Optional VMs are images published by Fortinet and are made available for download for FortiSandbox devices. These VMs are specific to the firmware version where the latest version has access to the latest VMs.

The VM name shows the operating system (OS) type, version and revision. For example, WIN10X64VMO16V4 VM Image means that the VM is a Microsoft Windows 10 64-bit for the OS and installed with Microsoft Office 2016. V4 means revision 4.

When Fortinet publishes a new version of a VM image, the image appears in the *Optional VMs* group with an option to download.

To use the optional VM:

Prerequisite: The VM image server (*fsavm.fortinet.net*) must be accessible. For VM models in which the Default VM is not pre-installed, the Default VMs also can be downloaded and installed here.

1. Click Tools > Add VMs from FortiGuard.
2. Choose the appropriate VM image and click *Download*.
3. After downloading all the images, click *Ready for Installation* to install all downloaded images. A reboot is not necessary for installation.
4. The license key is verified. If no corresponding keys are available, the image can still be downloaded and installed; however, the image cannot be enabled or activated until the required keys are imported. To view all installed VMs, use the CLI command: `vm-status`.
5. After the image is installed, you can start using it by setting its clone number to be greater than 0. The image status changes to *In-Use* after the activation and initialization process are implemented successfully.



Best practice:

To optimize the activation and initialization process, we recommend setting the number of clones to 1 first, waiting for the initialization to complete and the status to change to *In-Use*, and then expanding the number of clones as needed.

FortiSandbox supports different versions of Windows OS: Windows 11, Windows 10, Windows 8.1 and Windows 7. In Windows 10, Microsoft has published several editions where the following are distinctly supported by FortiSandbox:

- Windows 10 Enterprise 2015 LTSB (x64)
- Windows 10 IoT Enterprise LTSC 21H2.
- Windows 11 IoT Enterprise LTSC 22H2 (x64)

These versions and editions have different license keys. The license key must correspond to the specific OS edition for successful activation. The license keys cannot be interchanged.

If you intend to enable Default and Optional Windows VMs:

Please ensure you have sufficient Windows and Office license Keys corresponding to the version and edition of the Microsoft Windows and Office.

According to Microsoft licensing terms, each clone requires its own retail license to avoid activation issues and potential licensing violations. It is advisable to acquire the appropriate number of licenses based on your deployment requirements. Given file submission patterns, it might be useful to consider assigning one Office license for every five Windows licenses to ensure adequate scanning of Microsoft Office files. Additional licenses can be added as needed to boost capacity.

For example, to deploy 10 clones of the WIN11O21V1, it needs at least 10 available Windows11 Keys and 2 Office 2021 Keys. Otherwise, a message will appear.

For Custom VM, users do not need to upload the Windows keys to the FortiSandbox. Please verify that you have sufficient licenses for the Operating System and applications and that the number of VM clones does not exceed the available licenses. Keep the following considerations in mind:

- We recommend purchasing a new license, downloading the VMs, and then reassigning the clones.
- To save space, we recommend removing VMs that are no longer in use after you have installed and switched to a new VM.

To determine the Windows 10 edition of a guest VM:

1. Go to the *VM Settings* page.
2. In the *Action* column, click the *View Installed App* button.

To retrieve the system's license key:

Execute the CLI command `vm-license -l`.

The keys follow a specific format:

- Windows 10 Enterprise 2015 LTSC (x64) edition: `KEY_WIN10 25_digits_key`
- Windows 10 IoT Enterprise LTSC 21H2 edition: `KEY_WIN10 25_digits_key 2021`
- Default Key: These keys are the embedded key in the hardware units. They can be used to activate VMs and provide a VM clone capacity.
- UPG-LIC: These keys can be used to activate VMs and increase a VM clone capacity simultaneously.
- Key_Only: These keys are solely for activation purposes and compliance with licensing terms. They do not increase the clone pool capacity.

Custom VMs

Custom VMs are user created images uploaded to FortiSandbox. The VM may require software licenses for the installed OS and/or applications. You are required to prepare the corresponding license keys and activate them yourself. For more information, see [Setting up a custom VM on page 126](#).

Remote (Cloud) VMs

Fortinet supports *MACOSX* and *WindowsCloudVM* as remote VMs. You can purchase subscription services from Fortinet.

The Cloud VM for FortiSandbox PaaS supports scanning files for Windows, Microsoft Office, Linux, MAC and Android.

Remote MACOSX

Remote MACOSX VM supports scanning files for MacOS (.dmg, .mac, etc). In a cluster, each unit can enable the MACOSX clones using the available VM seat count license. The cloud VM seats are local to each unit and are not shared as of version 5.0.0.

Remote Windows

Remote WindowsCloudVM supports scanning files for Windows, Microsoft Office, Acrobat Reader, etc.

Besides the normal use of WindowsCloudVM, overflow mode is supported. All activated local windows can be configured to overflow to WindowsCloudVM. When *Local VM to use overflow* is selected, jobs that have utilized all local clones for selected VMs will be scanned to WindowsCloudVM instead of waiting for another local clone.

In a cluster, each unit in the cluster can enable the WindowsCloudVM clones using the available VM seat count license. The cloud VM seats are local to each unit and are not shared. Configuration to use overflow mode is also local to each unit.

Simulator VMs

Fortinet provides LinuxOT VM. For information, see [OT Simulation on page 128](#)



Enabled clone numbers are checked against allocated CPU and memory resources. If there are not enough resources, a warning message appears, and the setting is denied.

Supported OS versions

Platform	Operating System	Notes
Windows	Windows 10 and Windows 11	License required. Refer to the previous "Model, License, and VM Information" section. See, Model, License, and VM Information .
MacOS	Mac OS X 10.11	Available only on MacOS Cloud VM.

Platform	Operating System	Notes
Linux	Ubuntu 18 and Ubuntu 20	Available as an Optional VM and free to download and use. Does not require a dedicated key, but its clone occupies the quota of the clone limit.
Android	Android OS 13. Supported on hardware models and for the 64-bit apk file scan only.	Available as an Optional VM and free to download and use. It does not require a dedicated key, but its clone occupies the quota of the clone limit.

Configuring VM settings



This topic provides information on configuring virtual machine (VM) settings within FortiSandbox. It covers how to manage VM images, set the default browser, view installed applications, and understand VM usage and clone limits. It also includes instructions for uploading custom VMs, viewing running VMs, and troubleshooting common issues.



Known issue:

The newer CPU may not be fully compatible with the virtualization of the FortiSandbox. For more information, see [Troubleshooting cloning issues](#) in the *FortiSandbox Best Practice Guide*.

The *Scan Policy and Object > VM Settings* page displays the following information:

VM Settings Information	Description
VM Usage	Click <i>View VM Usage</i> to view usage for the past 24 hours. 
Installed Apps	Click <i>View Installed Applications</i> to view applications installed on a VM. For more information, see Viewing applications installed on a VM . 
Name	Name of the VM image. The name is unique in the system. If you upload a new VM image of the same name, the current installation is replaced. To see the VM's usage chart, click the <i>Chart</i> icon beside the <i>Name</i> .
Status	VM image status such as: <ul style="list-style-type: none"> • In-Use • Activated • Installed • Initializing

VM Settings Information	Description
Clone#	<p>VM clone number. Double-click the number to edit it and then click the green checkmark to save the new number. Click <i>Apply</i> to apply the change. The VM system re-initializes.</p> <p>The total clone number of all VM images cannot exceed the number of installed Windows licenses. For example, for FSA-3000F, the maximum clone number is 72. We recommend applying more than $8 + \text{clone_number} * 3$ of memory on your FSA unit.</p>
Browser	Set the default browser in Windows VMs. The original default browser may vary depending on the VM image.
File Types	<p>List of all the file types associated with the VM image. This means files of these types will be scanned by this VM if these types are determined to enter the job queue. The system decides if they need to be sandboxed.</p> <p>If the sandbox pre-filtering is turned:</p> <ul style="list-style-type: none"> • <i>Off</i> for a file type, it will be scanned inside each associated VM type. • <i>On</i>, files of this file type will be statically scanned first by an advanced analytic engine and only suspicious files will be scanned inside associated VM types. <p>You can define file type and VM association in Scan Policy and Object > Scan Profile. You can double-click the value to access the Scan Profile page to edit the list.</p> <p>When Windows Cloud VM is used in normal mode, file extensions can be modified and displayed. If it is used in overflow mode, only selected local windows VMs will be displayed.</p>

VM Settings Tools	Description
Add VMs from FortiGuard	Download and install the published Default and Optional VMs from the FortiGuard image server and add the Remote VMs into the VM Settings.
Upload Custom VM	Upload a Custom VM image from the local. For more information, see Setting up a custom VM on page 126 .
View Running VMs	<p>Take and view a screenshot of a running VM. When the admin user clicks the View Running VMs menu, all currently running guest VM clones will be displayed. Click the Screenshot button, then the PNG Link button to view a screenshot of the running clones.</p> <p>Clicking on the Interaction button of the running VM clones will open the VM clone's VNC monitor if the VNC feature is enabled by the CLI command: <code>vm-vnc -e</code>.</p> <p>This feature is useful to troubleshoot issues related to guest images.</p>

VM Clone Number Limit	Description
Local Clone Number	Counts the number of local VM clones in-use and provides the limit. Local VMs include Default VMs, Optional VMs and Custom VMs. The simulator VM (LinuxOT) is not included.

VM Clone Number Limit	Description
	For example: <ul style="list-style-type: none"> • FSA-3000G: The maximum local clone number is 150. • FSA-3000F: The maximum local clone number is 72. • FSA-1500G: The maximum local clone number is 28. • FSAVM00: The maximum local clone number is 8.
Total number of clones	The total number of clones in-use and the limit. The count includes both the local VM clones and remote VM clones. The simulator VM (LinuxOT) is not included. The limit is calculated by the number of VM Clone subscriptions. To expand the unit's scan power, you can purchase more clone subscriptions than the local clone limit and enable the remote WindowsCloudVM and remote MACOSX clones. Then files can be sent to Fortinet Cloud Sandboxing to scan.

Set the default browser

Set the default browser in Windows virtual machines. This feature is supported in Default, Optional, Custom Windows VMs, and WindowsCloudVM. The original default browser may vary depending on the VM image.

Supported Browsers and minimum required version:

- Google Chrome v75.0.3770.80
- Mozilla Firefox v90.0
- Microsoft Edge v86.0.622.61
- Microsoft Internet Explorer

Local Windows VM:

Chrome, FireFox and Edge are not listed if the installed version on the VM is lower than minimum required.

Custom VM:

All browsers are listed regardless of whether the browser is installed on the VM. If the configured browser is not installed, the URL will be opened by the default browser. If the configured browser is installed but does not meet the required version, the URL will be opened but cannot be scanned properly.

On the *Job Detail*, the browser used in the VM can be viewed in the *Process Information* under the *Tree View* tab.

To set the default browser in a Custom VM:

1. Go to *Scan Policy and Object > VM Settings*.
2. In the *Browser* column, click the *OriginalDefault* dropdown, and select a browser from the list.

Viewing applications installed on a VM

The applications list is available in Default VMs and Optional VMs by default. You can use a meta file to upload a list of applications installed on a custom VM.

To view the applications list for Default and Optional VMs:

1. Go to *Scan Policy and Object* > *VM Settings*. The *Installed Apps: <vm-name>* dialog opens.
2. In the *Default VMs* or *Optional VMs* section, click *View installed apps*.

To upload an applications list for Custom VMs:

1. Go to *Scan Policy and Object* > *VM Settings*.
2. In the *Custom VMs* section, click *View installed apps*. The *Installed Apps: <vm-name>* dialog opens.

3. Click *Browse* and navigate to the meta file location.
Meta file requirements:
 - Apostrophes (') and quotation marks (") are not supported.
 - The maximum number of characters in per line is 120.
 - The maximum number of lines in a meta file is 50.
4. Click *Upload meta file*. After uploading the application list will be displayed in the *Installed Apps: <vm-name>* dialog.



The application list is also available in the *VM Association* tab.

To view the list, go to *Scan Policy and Object* > *Scan Profiles* > *VM Association* and select a Custom VM.

VM status behavior during installation or clone modification

When an admin user performs either of the following actions:

- Installs a new Virtual Machine (VM), or
- Modifies the number of VM clones (e.g., activating a VM by changing the count from 0 to 1, or incrementing/decrementing the number of clones)

The overall status of all VMs changes from *Passed* to *Processing* and all VMs, including active VMs, become temporarily unavailable.

This is because any modification to the VM configuration triggers the Virtual Hosts Initialization process. During this process, the system status will reflect *Processing* until initialization completes.

We recommend allowing the initialization process to complete. The VM status will return to *Passed* and normal operation will resume once the changes are fully applied.

Setting up a custom VM

Create a Custom VM

You can use the GUI to upload a Custom VM or create a Custom VM from the installed Default and Optional VM in appliance-based and private cloud FortiSandbox devices. Admins must have *Read Write* privileges to upload a custom VM.



This feature is not supported on AWS/Azure/GCP/OCI Non-Nested mode and FortiSandbox Cloud.



Please refer to the FortiSandbox Custom VM Guide when creating your Custom VM. This guide is available to FortiSandbox customers with access to the [Fortinet Developer Network](#) or is available upon request from [Customer Support](#).

Recommended memory and CPU allocations:

VM	Memory	CPU
Windows	4 GB	2
Linux	2 GB	2

These values can be configured when uploading or editing a Custom VM. Note that increasing a VM's resource allocation may reduce the maximum number of clones the system can support.

To upload a custom VM:

1. Go to *Scan Policy and Object > VM Settings*.
2. In the toolbar, click *Tools > Upload Custom VM*.
3. Configure the Custom VM.

Name	The name cannot exceed 15 characters. Only letters and numbers are supported.
CPU Cores	Default is 1. Maximum of two cores are supported.
Memory	Default is 1024MB. Maximum of 4096 MB memory is supported. Using a large size of memory may result in not being able to run the maximum number of clones allowed.
Activated VM	If the VM is pre-activated, please select this option and input the system UUID of the Custom VM. After uploading, please enter the Custom VM modification mode to check the activation status or re-activate in modification mode if the activation is lost. For details, see Configure a custom VM on page 127 .
OS Type	Default is <i>Windows7</i> .

Options include: *Windows7, Windows8, Windows10, Windows11, Linux*, etc.

- Select VM Image** Select the Custom VM image file to be uploaded from the local folder. This should be a vdi file.
- NOTE:** VDI is the officially supported VM image format. Other formats should be converted to VDI before upload. We recommend the following conversion tools: VBoxManage and qemu-img..

4. Click *Upload VM Image*. The system starts uploading VM images. Upload time will vary depending on your network.
5. After the upload is complete, the system will automatically install the Custom VM. If the installation is successful, refresh the VM Settings page to view the VM in the *Custom VMs* list.

To create a Custom VM from the installed Default and Optional VM:

This feature is only available for the installed Default and Optional Windows VMs and Optional Ubuntu VMs.

1. Go to *Scan Policy and Object > VM Settings*.
2. Click the *Create* icon  in the Default or Optional VM row you plan to duplicate.
3. Enter the *Name*, *CPU Cores* and *Memory* settings for the new Custom VM and click *Create*.

Configure a custom VM

Custom VM modification is supported on the appliance-based, private cloud and public cloud Nested units. Modifications are not supported on cloud Non-Nested deployments such as Non-Nested FortiSandbox on AWS, Azure, GCP and FortiSandbox Cloud. Admins must have *Read Write* privileges to modify a custom VM.



Please refer to the *FortiSandboxCustom VM Guide* when developing your Custom VM. This guide is available to FortiSandbox customers with access to the [Fortinet Developer Network](#) or is available upon request from [Customer Support](#).

To modify a custom VM:

1. Go to *Scan Policy and Object > VM Settings*.
2. Under *Custom VMs*, ensure the *Clone #* is zero.
3. Click the *Customize VM* icon .
4. Configure the VM settings that will be used for the VNC session. After saving, the settings will be also applied to the running configuration of the VM.

VM Name	The name cannot exceed 15 characters. Only letters and numbers are supported.
CPU Cores	Default is 1. Maximum of two cores are supported. Once VNC terminates the CPU value reverts to default.
Memory	Default is 1024. Maximum of 4096 MB memory is supported. Once VNC terminates the Memory value reverts to default.

5. Click *Start*. The system starts an instance of the VM type. This may take some time to complete.
6. Click *Mount an ISO* to install the software. Only ISO format is supported.

The mounted ISO will be connected as CD drive. Alternatively, you can transfer files via file sharing site over the Internet. You should only visit a trusted site to avoid any unexpected changes on your VM.
7. To allow the custom VM to connect to the Internet:
 - Set IP 192.168.56.31/24 on the interface with the last 3 and 4 digits of the Mac address being 38, for example, 00-15-5D-C8-**38**-20
 - Set IP 192.168.57.31/24 on another interface with the last 3 and 4 digits of the Mac address being 39, for example, 00-15-5D-C8-**39**-20
 - Set the default gateway as 192.168.57.1 .Set a valid DNS server
8. Click *Power Cycle* to restart the instance.
9. To save your modifications, shutdown first the custom VM instance first via VNC.
 - Click the *Save* icon to save all changes.
 - Click the *Save As* icon to save changes and then assign the current instance under a new name.
10. Click *Discard* to terminate the modification immediately and discard all the changes you have made.
11. (Optional) Return to *VM Settings*. You can click the *Download* icon  to download the VDI of all installed custom VM(s).

OT Simulation

The OT Malware scans for presence of OT related applications and networking protocols. The LinuxOT is a Linux VM to simulate the OT industry deployment. The VM supports the Siemens application and simulates:

- Modbus
- SNMP
- IPMI
- FTP
- TFTP protocols

The Sandbox Threat Intelligence subscription already includes the Industrial Security subscription which allows you to enable the simulation. To scan files, submit them through any Windows VM. If it is an OT Malware, the LinuxOT will capture that lateral movement behavior and access to those application and protocols.

Preparing the OT Simulator VM on FortiSandbox

1. check that the Industrial Security Service contract is valid with the CLI: `vm-license -l`
2. Go to the *VM Settings* page and click *Tools > Add VMs from FortiGuard*, and find *LinuxOT* under the *Simulator VMs* table.
3. Click the download icon in the *Actions* column of the *LinuxOT* row.
4. Click the *Install* button and wait for the installation to complete.
5. After installing, the *LinuxOT* VM will be listed in the *VM Settings* page with clone disabled.
6. Toggle the switch in the *Clone #* column to enable it then press *Apply* to save the changes.

Scanning the files with the Simulator VM enabled





1. To Scan a file using the Simulator VM, submit a scan job to the Windows VMs. The Simulator VM automatically detects network operations related to the simulated protocols.
2. After the scan is finished, check the job detail to confirm the following:
 - There should be more than one .pcap file in the *PCAP Information* section.
 - There should be at least one item in the *Network Operations* section.

Job Priority

This page displays the job queue priority list. The priority list can be dynamically adjusted by dragging and dropping the file type entry in order of priority. The closer an entry is to the top, the higher the priority.

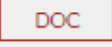
Once you have ordered your list, click *Apply* to save the change or *Reset* to go back to its default settings.

Job Queue Priority

#	Input Source	File Type
1	 On-Demand	 Executables/DLL/VBS/BAT/PS1/JAR/MSI/WSF files
2	 On-Demand	 User defined extensions
3	 On-Demand	 PDF files
4	 On-Demand	 Microsoft Office files (Word, Excel, PowerPoint files etc)
5	 On-Demand	 Adobe Flash files
6	 On-Demand	 Static Web files
7	 On-Demand	 Android files
8	 On-Demand	 Mac files
9	 URL On-Demand	 URL detection
10	 File RPC	 Executables/DLL/VBS/BAT/PS1/JAR/MSI/WSF files

Job Archive

The *Job Archive* page allows you to setup a network share folder to save a copy of scan job information. Archive location is a network share folder. Archiving job information is useful when processing job files and data with third party tools.



The Job Archive is only available in the Primary node of an HA cluster.

To view the *Archive Location* page, Go to *Scan Policy and Object > Job Archive* .

The following options can be configured:

Enabled	Select to enable the job archive feature.
Mount Type	Select the mount type of the network share folder: <ul style="list-style-type: none"> • SMB v1.0 • SMB v2.0 • SMB v2.1 • SMB v3.0 • SMB v3.1 • NFSv2 • NFSv3 • NFSv4 • Azure File Share • Azure Blob Storage • AWS S3 • AWS S3 BJ • AWS S3 NX
Server Name/IP	Enter the server fully qualified domain name (FQDN) or IP address.
Share Path	Enter the file share path in the format of /path1/path2.
Username	Enter a user name. The username should have the write privilege of the remote network share folder.
Password	Enter the password.
Confirm Password	Enter the password a second time for verification.
File Name	Select the file name from the dropdown list. The following options are available: <ul style="list-style-type: none"> • Scan Job ID as File Name • Original File Name
Folder Structure	Select the folder structure from the dropdown list. The following options are available: <ul style="list-style-type: none"> • Save all files in the same folder

	<ul style="list-style-type: none"> • Save file in folders of the scan finish time • Save file in folders of ratings
Password on Archive File	Enter the password for saved jobs.
Confirm Password on Archive File	Enter the password a second time for verification.
Save meta data	When selected, the job summary information will be saved.
Save tracer log	When selected, the job's tracer log will be saved.
Save Malicious rating jobs	When selected, files of Malicious rating will be saved.
Save Suspicious rating jobs	When selected, files of Suspicious rating will be saved.
Save Clean rating jobs	When selected, files of Clean rating will be saved.
Save Other rating jobs	When selected, files of Other rating will be saved.

Allowlist and blocklist

Allowlist and blocklist help improve scan performance, enhance malware catch rates, and reduce false positives. These lists can be appended to, replaced, cleared, deleted, and downloaded.

These lists contain file checksum values (MD5, SHA1, or SHA256) and domain/URL/URL REGEXs. Domain/URL/URL REGEX lists are used in both file and URL scanning. For files, the downloading URL is checked against the list.

Wild Card formats, such as *.domain, are supported. For example:

- If a user adds windowsupdate.microsoft.com to the *Allow Domain List*, all files downloaded from this domain will be immediately rated as *Clean*.
- If *.microsoft.com is added to the *Allow Domain List*, all files downloaded from and subdomains of microsoft.com will be also be immediately rated as *Clean*.

For URLs, you can add a raw URL or a regular expression pattern to the list. For example, if a user adds *.amazon.com/. *subscribe to the allowlist, all subscription URLs from amazon.com will be immediately rated as *Clean*. This way, subscription links will not be opened inside the VM and become invalid.

- If an allowlist entry is hit, the job rating will be *Clean* with a local overwrite flag.
- If a blocklist entry is hit, the job rating will be *Malicious* with a local overwrite flag. Malware names will be FSA/BL_DOMAIN, FSA/BL_URL, FSA/BL_MD5, FSA/BL_SHA1, or FSA/BL_SHA256.
- If the same entry exists on both lists and is hit, the blocklist will take priority and the file will be rated *Malicious*.



In an HA cluster, create the allowlist and blocklist on the primary node. The lists will be synchronized with the other nodes in the cluster.

To manually manage the allowlist and blocklist:

1. Go to *Scan Policy and Object > Allowlist/Blocklist*.
2. Click the menu icon beside *Allowlists* or *Blocklists*.
3. Click the + button to add a new entry.
4. Click *OK*.



The domain pattern has higher priority than URL pattern.

For example, if you enter *.microsoft.com in a domain blocklist and http://www.microsoft.com/abc/bad.html in an URL blocklist, a file from http://www.microsoft.com/abc/bad.html will be rated by the *Domain in Blocklist*.

To use files to manage the allowlist and blocklist:

1. Go to *Scan Policy and Object > Allowlist/Blocklist*.
2. Beside *Allowlists* or *Blocklists*, click the menu icon and select the *Manage lists by uploading files* icon.
3. Select the list type from the dropdown menu:
 - MD5
 - SHA1
 - SHA256
 - Domain
 - URL
 - URL REGEX
4. Select the *Action* from the dropdown menu:
 - *Append*: Add checksums to the list.
 - *Replace*: Replace the list.
 - *Clear*: Remove the list.
 - *Download*: Download the list to the management computer.
 - *Delete*: Delete an entry from the list if the entry is in the uploaded file.
5. If the action is *Download*, click *OK* to download the list file to the management computer.
6. If the action is *Append* or *Replace*, click *Upload a File Containing Allowlist / Blocklist*, locate the checksum file on the management computer, then click *OK*.

The *Upload a File Containing Allowlist / Blocklist* option only supports plain text file format. Each line in the file must contain either a single column with a valid checksum, URL, IP address or Domain name, or four columns: value, comment, expiry_date, and status.

Examples:

```
youtube.com, append test, 1734633094, enabled
a3a58ab7c0244e4b2371f1889f217c2b, md5 test, 1734678094, disabled
```

The expiration date supports the following formats:

- Epoch timestamp (e.g., 1720502400)
- Date-only format (%Y-%m-%d, e.g., 2025-07-09)
- US format (%m-%d-%Y, e.g., 07-09-2025)
- European format (%d-%m-%Y, e.g., 09-07-2025)
- Slash-separated ISO format (%Y/%m/%d, e.g., 2025/07/09)

- Slash-separated format (%d/%m/%Y, e.g., 09/07/2025)

The compact format (%Y%m%d) is not supported. All expiration dates must fall within the range from the current and up to five years in the future.

If the *Blocklist Type* is set to *URL*, then *Add blocklist to TCP RST* is displayed. When this is enabled, all entries in the uploaded file will be added to the custom block list file of TCP RST packets. For more information, see [TCP RST package on page 143](#)

Blocklist Upload

Blocklist Type:	<div style="border: 1px solid #ccc; padding: 2px;">URL ▼</div>
Action:	<div style="border: 1px solid #ccc; padding: 2px;">Append ▼</div>
<input type="checkbox"/> Add blocklist to TCP RST	
<div style="border: 1px solid #ccc; padding: 5px; display: inline-block;"> Upload a File Containing Blocklist </div>	

7. If the action is *Clear*, click *OK* to remove the list.



The total number of URL REGEXs in allowlist and blocklist must be less than 1000.
 The total number of domains plus URLs in allowlist and blocklist must be less than 50000.
 The total number of MD5+SHA1+SHA256 in allowlist and blocklist must be less than 50000.

Web Category

The FortiSandbox queries the FortiGuard Web Filtering Service to determine the Web Category of the URL. There are more than 90 web categories described at: <https://www.fortiguard.com/webfilter/categories>

The FortiSandbox has set a default risk rating on all web categories. The following categories are configurable to override its default rating. The categories that are not listed are set to a *Clean* rating and cannot be overridden.

Default Rating	Web Categories
Low Risk	Abortion Advocacy Organizations Alcohol and Tobacco Alcohol

Default Rating	Web Categories
	Child Abuse *
	Crypto Mining *
	Dating
	Discrimination *
	Drug Abuse
	Dynamic DNS *
	Explicit Violence
	Extremist Groups
	Gambling
	Grayware
	Hacking
	Homosexuality
	Illegal or Unethical *
	Malicious Websites
	Marijuana
	Newly Registered Domain *
	Nudity and Risque
	Occult *
	Other Adult Materials
	Phishing
	Plagiarism *
	Pornography *
	Potentially Unwanted Program *
	Spam URLs, Terrorism *
	Tobacco
	Weapons (Sales)
	* Updated in 4.4.0 from <i>Clean</i> to <i>Low Risk</i> .
Clean	URL Shortening

Using URL Pre-Filter settings

The URL Pre-filter feature uses the web filtering categories to skip the Dynamic scan to increase throughput. This feature is disabled by default and all URLs get forwarded to Dynamic scan.

When URL Pre-Filter is enabled, it will work together with the Scan Profile and Web Category settings.



If the FortiSandbox has Real-Time Anti-Phishing service, URLs that are forwarded to Dynamic scan are also sent to the service to check for Phishing, Malicious or Spam websites. For more information, see [Real Time Anti-Phishing on page 194](#).

Scenarios:

URL Sandboxing Pre-Filter is *Disabled*.

All URLs will be forwarded to Dynamic scan to check any suspicious behavior. Expect that the scan throughput will be slower.

URL Sandboxing Pre-Filter is *Enabled*.

1. If the category of the URL is *Unrated, Newly Observed Domain* and *Newly Registered Domain*, the URL will be forwarded to Dynamic scan to check any suspicious behavior.
2. Otherwise, the URL will not be forwarded to Dynamic Scan. The URL will be rated by *Static Scan Engine* using the default or overridden rating (see the example below).

Example

You can change the *Gambling* category from *Low risk* to *Medium risk*. Then, try to submit the URL <http://www.lottolore.com/lotto649.html>. The Job Report should show: *Medium risk rating, Gambling category and Rated by Static Scan Engine*.

Customized Rating

Use the *Customized Rating* page to set verdicts for the following cases: *VM Timeout, Tracer Engine Timeout, Unextractable Encrypted Archive*, and *URL whose return code is not 200*, and files that encountered an application crash.

The following options can be configured:

VM Launch Timeout	Occurs when Windows VM cannot be launched properly. This usually occurs on FSA-VM model running on hardware with limited resources.
Tracer Engine Timeout	Occurs when the Tracer Engine is not working properly. For example, the malware crashes the Windows VM or kills the Tracer Engine process. Thus, the tracer log is not available.
Unextractable Encrypted Archive	The archive file is password protected and cannot be extracted with a predefined password list set in the <i>Scan profile > Advanced tab</i> .
Undecryptable Office/PDF	The Office/PDF file is password protected and cannot be extracted with a predefined password list set in the <i>Scan profile > Advanced tab</i> .
URL with a return code other than 200 OK	Blocks any URL sent to FortiSandbox which returns anything other than <i>200 OK</i> . You can disable this option by selecting <i>Not Applied</i> .

Application crash upon file opening

Identifies files which encountered application crash during VM scan. For example, when an excel file is scanned inside a VM, it encounters MS EXCEL crash.

Embedded script in Office/PDF files

Identifies Office/PDF files which have embedded scripts or executables.

You can select one of the following ratings for each option:

- Not Applied (Default)
- Unknown
- Clean
- Malicious
- Low Risk
- Medium Risk
- High Risk



By default, all customized ratings are set as *Not Applied*. For any other value, the customized rating always takes higher priority if it applies.

YARA Rules

YARA is a pattern matching engine for malware detection. It can be applied for files as well as downloaders. The YARA Rules page allows you to upload your own YARA rules.



In v4.4.0, FortiSandbox upgraded Yara Engine to v4.2.3. The rules must be compatible with the 4.x.x schema and put inside ASCII text files.

For more information about writing YARA rules, see the product [documentation](#). There are known issues for Yara Engine v4.2.3, see the issue report [community](#).

FortiSandbox supports following Yara modules:

Cuckoo, Magic, Dotnet, PE, ELF, Hash, Math, Time, Console and String. For information about YARA modules, see the [product documentation](#).

The following options are available:

Import

Select to import a YARA rule file. You can apply one YARA rule to multiple file types.

Edit

Select to edit a YARA rule file. You can apply one YARA rule to multiple file types.

Delete	Select to delete a YARA rule file.
Change Status	Select to change the status (Active or Inactive) of a YARA rule.
Export	Select to export a YARA rule file.

The following information is displayed:

Name	The name of the YARA rule set.
File Type	The file types the YARA rule is applied to.
Modify Time	The date and time the YARA rule set was last modified.
Size	The size of the YARA rule file.
Sha256	The Sha256 checksum of the YARA rule file.
Status	The current status (Active or Inactive) of the YARA rule set.

Format guidelines for regular YARA Rules

- Rule file must be in plain text format
- Rule file can contain many rules
- Rule name must be unique
- Rule should be in the following format:

```
rule ExampleRule Name xxx
{
  strings:
    $my_text_string = "XXXXX"
    $my_hex_string = { XXXXXX }
  condition:
    $my_text_string or $my_hex_string
}
```

For more information about writing YARA rules, see the product [documentation](#).

To upload YARA Rule File:

1. Go to *Scan Policy and Object* > *YARA Rules*.
2. Select *Import*.
3. Configure the following settings:

YARA Rule Name	Enter a name for the YARA rule set.
Default Description	Enter a description of the YARA rule set.
Rules Risk Level	Select a rule risk level between 1-10. <ul style="list-style-type: none"> • 0-1: Clean • 2-4: Low Risk

	<ul style="list-style-type: none"> • 5-7: Medium Risk • 8-10: High Risk <p>All the YARA rules inside the YARA rule file will share the same risk level.</p>
File Type	Select file types to scan against uploaded YARA rules. One YARA rule file can be applied to multiple file types.
YARA Rule File	Choose a text file containing YARA rules.

4. Select *OK* to import rules.
5. After a YARA Rule file is imported, you can select the *Activate/Deactivate* icon to enable/disable the YARA rule set.



If a file hits multiple rules, a complicated algorithm is used to calculate the final rating of the file. For example, if a file hits more than one Low Risk YARA rules, the file's verdict can be higher than the Low Risk rating.

To edit a YARA Rule set:

1. Go to *Scan Policy and Object > YARA Rules*.
2. Select a YARA Rule.
3. Click the *Edit* button from the toolbar.
4. Configure the following options:

ID	YARA ID number. You cannot edit this field.
Yara Rule Name	Enter a name for the YARA rule set.
Default Description	Enter a description of the YARA rule set.
Rules Risk Level	<p>Select a rule risk level between 1-10.</p> <ul style="list-style-type: none"> • 0-1: Clean • 2-4: Low Risk • 5-7: Medium Risk • 8-10: High Risk <p>All the YARA rules inside the YARA rule file will share the same risk level.</p>
File Type	Select file types to scan against uploaded YARA rules. One YARA rule file can be applied to multiple file types.
YARA Rule File	Choose a text file containing YARA rules.

5. Click *OK* to apply changes.

To delete a YARA rule set:

1. Go to *Scan Policy and Object > YARA Rules*.
2. Select a YARA Rule set.
3. Click *Delete* from the toolbar.
4. Click *Yes I'm sure* button from the *Are you sure?* confirmation box.

To change the status of a YARA rule set:

1. Go to *Scan Policy and Object > YARA Rules*.
2. Select a YARA Rule set.
3. Click *Change Status*. The status of the selected YARA rule will switch to *Active* or *Inactive* depending on its previous status.



Regular YARA rule is applied in both the Static Scan stage and VM Engine scan stage. During the VM Engine scan stage, if any dump file hits the regular YARA rule, the *Indicators* section will show the User-defined YARA with the YARA rule name.

To import a process memory YARA Rule:

A process memory YARA Rule differs slightly from other YARA rules. It is used by the VM Engine and is only applied in the VM Engine scan stage whereas a regular YARA rule is applied in both the Static Scan stage and VM Engine scan stage.

1. Go to *Scan Policy and Object > YARA Rules*.
2. Click the *Import* button.
3. Input a YARA rule name in the *Yara Rule Name* field.
4. Add a description for the YARA Rule if there is no corresponding field contained in the rule's *meta* section.
5. In the *Apply On:* field, click *Process Memory*. The *Rules Risk Level* field will be hidden upon click because it is not required for *Process Memory*.

Import Yara Rules

Yara Rule Name:
May contain letters, numbers and ./_ characters only

Default Description:
Default description for rules in case of there's no such field in the rule's meta section

Apply On:

Process Memory
 Any File
 EXE
 DLL

If Process Memory is selected, no file type can be selected

6. Click *Upload YARA File* and select the YARA Rule file.
7. Click *OK*.

To verify when a sample is detected by a process memory YARA rule:

If a sample is detected by a process memory YARA rule, FortiSandbox will show the following information in the FortiView job details:

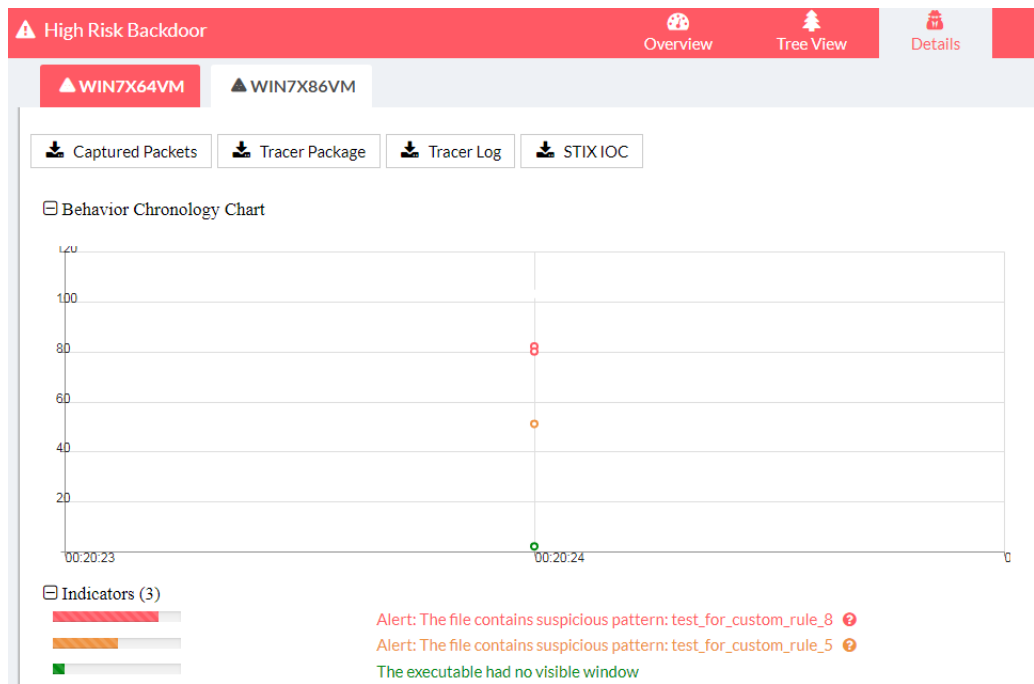

- The Indicators section shows that the sample contains a suspicious pattern with the YARA rule name.
- The YARA rule and rating are displayed as Behaviors.

If a sample is detected by multiple process memory YARA rules, FortiSandbox shows all hits and takes the highest scoring YARA rule as the final scan score if no other suspicious behavior is detected.

Format guidelines for process memory YARA Rules

- A rule file must be in plain text format
- A rule file can contain many rules
- A rule name must be unique
- A rule should be in the following format:

```
rule Andromeda29_Memory_Pattern
{
meta:
description = "Andromeda29"
impact = 8
condition:
...
}
description: description of the rule, it will show in the indicator if matched
impact: the impact level of the pattern, range: 0-10, 0-1:clean,2-4: Low Risk,5-7: Medium Risk,8-10:High Risk
```

To activate the process memory YARA Rule

1. Select the YARA Rule in *Scan Policy and Object > Yara Rules*, then click *Change Status* to activate the YARA rule. Clicking the *Change Status* button again will toggle the *Status* between Active and Inactive.

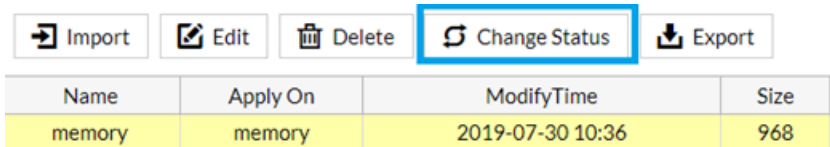

To export a YARA rule:

1. From *Scan Policy and Object > Yara Rules*, click *Export* to export this YARA rule in plain text format.

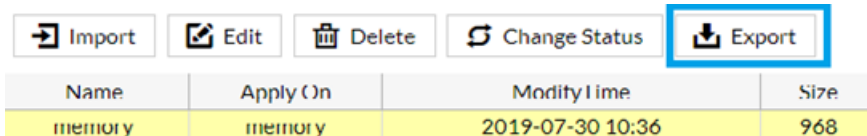

Malware Package

Go to *Scan Policy and Object > Malware Package*, to view the Malware Package list.

When a scan job is rated as *Malicious* or *Suspicious* (High, Medium or Low Risk) it is marked as false positive, then the system will automatically remove it from the malware package. However, when a job is rated as *Clean* it is marked false negative. A false negative is not added to the malware package because it can introduce a major breakdown of the fabric without FortiGuard intervention (for example, a Windows file is accidentally overridden to become false-negative).

The following options are available:

Refresh	Refresh the Malware Package list.
View	<p>Select a package version number and click the <i>View</i> button from the toolbar. The following information is shown:</p> <ul style="list-style-type: none"> • <i>Status</i>: Indicates the file is enabled or disabled in the current package. • <i>Detected</i>: The date and time the item was detected. • <i>SHA256</i>: The file checksum (SHA256). • <i>Rating</i>: The risk rating. • <i>Serial Number</i>: The unit the threat information is coming from. • <i>Global/Local</i>: Indicates if the threat information is coming from a local unit or from another unit. • <i>File Name</i>: The detected file name. • <i>File Type</i>: The detected file type. • <i>Infected OS</i>: The infected OS that was scanned. <p>You can filter entries by applying search criteria based on the columns above.</p>

You can remove multiple entries by selecting the checkbox for each entry, or click the checkbox in the title bar to select all displayed entries. After selecting the entries, you can choose *Enable Selected* or *Disable Selected* to batch remove multiple entries.

Download SHA256	You have the option to download packages containing malware SHA256, SHA1, and MD5.
Download SHA1	
Download MD5	

This page displays the following:

Version	The malware package release version.
Release Time	The malware package release time.
Total	The total number of malware antivirus signatures inside the package. The maximum number of signatures is 100K.



By default, FortiSandbox only keeps malware packages generated in last 3 days.

URL Package

Go to *Scan Policy and Object > URL Package* to view the URL Package list.

The following options are available:

Refresh	Refresh the URL Package list.
View	<p>Select a package version number and click the <i>View</i> button from the toolbar. The following information is shown:</p> <ul style="list-style-type: none"> • Job Detail: View the downloaded file's detailed information. If the unit is joining a global threat information sharing network, only local detection has the Job Detail button available. • Mark the URL as False Positive: If marked, the URL will be removed from future URL packages. If the unit is joining a global threat information sharing network, the change is also reported to the <i>Collector</i> and is shared by all units in the network. A new package will generate after removing the entry. • Detected: The time and date that the item was detected. • URL: The URL in the package. • Rating: The risk rating of the downloaded file. • Serial Number: From which unit the threat information is from. • Global/Local: If this threat information is from a local unit, or from another unit.
Download URL	Download a text file which contains URLs in the package.

This page displays the following:

Version	The URL package release version.
Release Time	The URL package release time.
Total	The total number of malware antivirus signatures inside the package. The maximum number of signatures is 1000.



By default, FortiSandbox only keeps URL packages generated in last 3 days.

TCP RST package

Go to *Scan Policy and Object > TCP RST Package* to view the FortiSandbox Sniffer TCP RST list.

The following options are available:

Refresh	Refresh the TCP RST Package list.
View	<p>Select a package version number and click the <i>View</i> button from the toolbar. The following information is displayed:</p> <ul style="list-style-type: none"> • Job Detail: View the downloaded file's detailed information. • Remove from TCP RST package: If marked, the URL will be removed from future TCP RST packages. • Detected: The date and time that the item was detected. • Host/IP: From where the URL is from. • URL: The URL in the package. • Rating: The risk rating of the downloaded file.
Package Options	Configure how the packages are generated.
Download Blocklist	Download the <i>FSA Detected Blocklist</i> or <i>Custom Blocklist</i> .
Upload Custom Blocklist	<p>Upload a user-defined blocklist to FortiSandbox.</p> <p>File requirements:</p> <ul style="list-style-type: none"> • Text files are supported • One URL per line • URLs, IPs and domains are supported <p>Example:</p> <pre>http://www.example.com www.test.net http://192.0.2.100 198.51.100.101</pre> <p>After the file is uploaded it will overwrite previous versions of the custom blocklist if there are any.</p>

In an HA Cluster , the custom blacklist will only be synced to a new primary node when failover occurs.

Delete Custom Blocklist Delete a user-defined blacklist.

The *TCP RST Package* page displays the following information:

Version	The TCP RST package version.
Release Time	The TCP RST package release time.
Total	The total number of URLs inside the package.

To configure a TCP RST package:

1. Go to *Scan Policy and Object > TCP RST Package*.
2. Click *Package Options* and configure the following settings.

Includes past 14 day(s) of data	Enter a value between 1-365 days.
Includes job data of the following ratings	Select <i>Malicious, High Risk</i> or <i>Medium Risk</i> .

3. Click *OK*.

Threat Intelligence

Threat Intelligence defines conditions to generate threat packages. If the unit joins the Global Threat Network, the page will display: *The unit has joined the threat information global network and is working as a contributor/collector. To configure settings, please go to the Global Network page.* The user should configure package conditions there.

Malware and URL Package Options

The malware package options and URL package options allow you to configure how many days worth of data the malware and URL packages save and the malware ratings that are included in the packages.

In a cluster environment, only the primary node generates malware packages and URL packages.

You can also select to include files or URLs to packages during an *On-Demand* scan if their results meet package settings.

Because of size limitations, the following limits are in effect:

- Malware packages can have a maximum of 100K entries.
- URL package can have a maximum of 1000 entries.

The URL package contains downloaded URLs of detected malware.

Local Malware Package Options	
Include past __ day(s) of data. (1-365 days)	Enter the number of days. If the user changes the current days to a longer value, the unit will not go back to include historical data older than current days.
Include the job data of the following ratings	
Malicious	Include malware with malicious ratings. By default, only data with Malicious or High Risk rating will be included in the Malware Package.
High Risk	Include malware with high risk ratings and URLs sent by FortiMail devices of high risk ratings and whose scan depth is 0.
Medium Risk	Include malware with medium risk ratings and URLs sent by FortiMail devices of medium risk ratings and whose scan depth is 0.
Local URL Package Option	
Include past __ day(s) of data. (1-365 days)	Enter the number of days. If the user changes current days to a longer value, the unit will not go back to include historical data older than current days.
Include the job data of the following ratings	
Malicious	Include downloaded URLs of malware with malicious ratings. By default, only downloaded URLs of malware with a Malicious or High Risk rating will be included in the URL Package.
High Risk	Include downloaded URLs of malware with high risk ratings.
Medium Risk	Include downloaded URLs of malware with medium risk ratings.
Enable STIX IOC	Enable to generate STIX IOC packages.
STIX Malware Package Options	
Include past __ day(s) of data. (1-365 days)	Enter the number of days.
Include the job data of the following ratings	
Malicious	Include malware with malicious ratings.
High Risk	Include malware with high risk ratings.
Medium Risk	Include malware with medium risk ratings.
Generate STIX file with behavior	Include behavior information of each malware or suspicious URL.
Download STIX	Download most recently generated Malware STIX IOC package.

STIX URL Package Options

Include past __ day(s) of data. (1-365 days) Enter the number of days.

Include the job data of the following ratings

Malicious	Include malware with malicious ratings.
High Risk	Include downloaded URLs of malware with high risk ratings and URLs sent by FortiMail devices of high risk ratings and whose scan depth is 0.
Medium Risk	Include downloaded URLs of malware with medium risk ratings and URLs sent by FortiMail devices of medium risk ratings and whose scan depth is 0.
Download STIX	Download most recently generated URL STIX IOC package.

STIX/TAXII Integration

API Root URL	Enter the root URL for STIX/TAXII server.
TAXII Username	The username to access STIX/TAXII server
TAXII Password	The password for the user.
Collection ID	The collection setup on STIX/TAXII server.

Include job data of the following ratings

Malicious	Include malware with malicious ratings.
High Risk	Include high risk ratings job.
Medium Risk	Include medium risk job.

FortiSandbox supports sending STIX format to external STIX/TAXII server. When enabled, this feature will send a file added to malware package in STIX format to a pre-configured external STIX/TAXII server.



Malicious files directly rated by AV are not sent to external threat server since they do not have STIX format.

Configuration example

API Root URL	http://192.168.4.160:5000/trustgroup1/
TAXII Username	admin
TAXII Password	Password0
Collection ID	365fed99-08fa-fdcd-a1b3-fb247eb41d01

IOC Package

Indicator of Compromise (IOC), in computer forensics, is an artifact observed on a network or in an operating system which indicates a computer intrusion. Typical IOCs are virus signatures and IP addresses, malware files or URLs MD5 hashes, or domain names of botnet command and control servers. In order to share, store and analyze in a consistent manner, Structured Threat Information Expression (STIX™) is commonly adopted by the industry.

FortiSandbox supports IOC in STIX v2 format. Two types of IOC packages are generated:

1. A File Hash Watchlist package contains the Malware's file hash and is generated along with each Malware package. If the malware is detected in local unit, behavioral information is also included. The most recent package can be downloaded from *Scan Policy and Object > Global Network* or *Scan Policy and Object > Threat Intelligence*, depending on if the unit joins a Global Threat Network.
2. A URL Watchlist package contains the Malware's download URL and is generated along with each URL Package. It also contains URLs sent by FortiMail devices of suspicious ratings and whose scan depth is 0. The most recent package can be downloaded from *Scan Policy and Object > Global Network* or *Scan Policy and Object > Threat Intelligence*, depending on if the unit joins a Global Threat Network. Behavioral information is not included in URL package.

The following is a example snippet of a File Hash Watchlist ICO package in STIX format:

```
<stix:STIX_Package
  xmlns:FileObj="http://cybox.mitre.org/objects#FileObject-2"
  xmlns:FortiSandbox="http://www.fortinet.com"
  xmlns:cybox="http://cybox.mitre.org/cybox-2"
  xmlns:cyboxCommon="http://cybox.mitre.org/common-2"
  xmlns:cyboxVocabs="http://cybox.mitre.org/default_vocabularies-2"
  xmlns:indicator="http://stix.mitre.org/Indicator-2"
  xmlns:stix="http://stix.mitre.org/stix-1"
  xmlns:stixCommon="http://stix.mitre.org/common-1"
  xmlns:stixVocabs="http://stix.mitre.org/default_vocabularies-1"
  xmlns:ttp="http://stix.mitre.org/TTP-1"
  xmlns:xsi="http://www.w3.org/2001/XMLSchema-instance" id="FortiSandbox:Package-ba2ad205-b390-
    40fd-96e4-44c2efaacab1" version="1.2">
<stix:STIX_Header/>
<stix:Indicators>
  <stix:Indicator id="FortiSandbox:indicator-7d3e889e-957c-428c-9f68-8e48d3346316" timestamp="2016-
    08-12T18:25:52.674621+00:00" xsi:type='indicator:IndicatorType'>
    <indicator:Title>File hash for Suspected High Risk - Riskware</indicator:Title>
    <indicator:Type xsi:type="stixVocabs:IndicatorTypeVocab-1.1">File Hash
      Watchlist</indicator:Type>
    <indicator:Observable id="FortiSandbox:Observable-723483db-a3e0-4de0-93cd-5bd37b3c4611">
      <cybox:Object id="FortiSandbox:File-3d9e7590-b479-4352-9a11-8fa313cee9f0">
        <cybox:Properties xsi:type="FileObj:FileObjectType">
          <FileObj:Hashes>
            <cyboxCommon:Hash>
              <cyboxCommon:Type xsi:type="cyboxVocabs:HashNameVocab-
                1.0">SHA256</cyboxCommon:Type>
              <cyboxCommon:Simple_Hash_Value
                condition="Equals">0696e7ec6646977967f2c6f4dcb641473e76b4d5c9beb6e433e0
                229c2acce5d</cyboxCommon:Simple_Hash_Value>
            </cyboxCommon:Hash>
          </FileObj:Hashes>
        </cybox:Properties>
      </cybox:Object>
    </indicator:Observable>
  </stix:Indicator>
</stix:Indicators>
```

```

</indicator:Observable>
<indicator:Indicated_TTP>
  <stixCommon:TTP idref="FortiSandbox:ttp-afa9d28b-9602-4936-8b94-93e29cc8830c"
    xsi:type='ttp:TTPType' />
</indicator:Indicated_TTP>
</stix:Indicator>
</stix:Indicators>
<stix:TTPs>
  <stix:TTP id="FortiSandbox:ttp-afa9d28b-9602-4936-8b94-93e29cc8830c" timestamp="2016-08-
    12T18:25:52.674181+00:00" xsi:type='ttp:TTPType'>
    <ttp:Title>Suspected High Risk - Riskware</ttp:Title>
    <ttp:Behavior>
      <ttp:Malware>
        <ttp:Malware_Instance>
          <ttp:Type xsi:type="stixVocabs:MalwareTypeVocab-1.0">Exploit Kits</ttp:Type>
          <ttp:Name>Suspected High Risk - Riskware</ttp:Name>
        </ttp:Malware_Instance>
      </ttp:Malware>
    </ttp:Behavior>
  </stix:TTP>
</stix:TTPs>
</stix:STIX_Package>

```



If the IOC package includes behavior information, it can be very large.

Global Network

FortiSandbox can generate antivirus database packages (malware packages) and add URL packages from scan results into the blocklist, and distribute them to FortiGate devices and FortiClient endpoints for antispymware/antivirus scan and web filtering extension to block and quarantine malware.

This feature requires that the FortiGate and/or FortiClient EMS have successfully connected.

FortiGate or FortiClient sends a malware package request to FortiSandbox every two minutes that includes its installed version (or 0.0, if none exists). The FortiSandbox receives the request then compares the version with the latest local version number. If the received version is different, FortiSandbox sends the latest package to the FortiGate or FortiClient. If the versions are the same, then FortiSandbox will send an already-up-to-date message.

Multiple FortiSandbox units can work together to build a Global Threat Network to share threat information. One unit works as a Collector to collect threat information from other units while other units work as Contributors to upload locally detected threat information to the Collector, then download a full copy. A new package is generated on a unit when:

- The FortiSandbox has a new malware detection, either from local detection, or detected on another unit inside the Global Threat Network, whose rating falls into configured rating range.
- Malware in the current malware package is older than the time set in the malware package configuration.
- The malware package generation condition is changed in the configuration page.

- The malware's rating has been overwritten manually.

The Collector can also manage the Scan Profile of all units in the network. However, only a standalone unit or primary node in a cluster can join the network.

To join the global network to share threat information and scan profiles:

1. Go to *Scan Policy and Object > Global Network*.
2. Enable *Join global network to share threat information and manage scan profiles*.
3. You have the following two options:
 - a. *Work as threat information collector and scan profile manager*.

If the unit works as a *Collector*, configure the following:

Alias	Enter the network Alias name.
Authentication Code	Enter the authentication code for Contributor to join the network.
Contributors	List the units who are in the network.
Local Malware Package Options	These options define how each unit generates local packages after it has threat information. For more information, see Threat Intelligence on page 144 .
Local URL Package Options	
Enable Local STIX IOC Package	

- b. *Work as threat information contributor. Scan profile is managed by manager*.

Only a standalone unit or cluster primary node can join global threat network as *Contributor*.

If the unit works as a *Contributor*, configure the following:

Collector IP Address	Enter the Collector's IP address.
Alias	Enter the global network Alias name.
Authentication Code	Enter the authentication code to join the network.
Local Malware Package Options	These options define how each unit generates local packages after it has threat information. For more information, see Threat Intelligence on page 144 .
Local URL Package Options	
Enable Local STIX IOC Package	
Scan Profile is Managed by Manager	When a unit joins the global threat network as a Contributor and enables this option, the scan profile will no longer be managed locally; instead, it will be managed on the global threat network Collector. Changes made on the Collector will be downloaded to the corresponding Contributor.

Note: When the scan profile is managed by the Collector, scan profile related CLI commands will also be disabled locally.

4. Click *OK* to save the settings.
-



When the Contributor's scan profile is managed by the Collector, the Collector must have network access to the Contributor's HTTPS port, which is port 443.

System

Use the *System* pages to manage and configure the basic system options for the FortiSandbox unit. This includes administrator configuration, mail server settings, and maintenance information.

System provides access to the following pages. Some pages do not display on worker nodes in a cluster.

Administrator	Configure administrator user accounts.
Admin Profiles	Configure user profiles to define user privileges.
Device Groups	Add devices to a device group and assign it to multiple device users.
Netshare Groups	Add network shares to a Netshare group and assign it to Netshare users.
Password Policy	Configure the password policy for all local administrators
Interfaces	Configure the Interface Status, IP Address / Netmask, and Access Rights.
DNS	Configure Primary and Secondary DNS servers.
Static Route	Configure the Destination IP/Mask, Gateway, and Device for a Static Route
LDAP Servers	Configure LDAP Servers.
SAML SSO	Configure SAML SSO.
RADIUS Servers	Configure RADIUS Servers.
Mail Server	Configure the Mail Server.
FortiGuard	Configure FortiGuard.
Certificates	Configure CA certificates.
Netshare Keys	Import Netshare Keys for Google Cloud Storage.
Login Disclaimer	Configure the Login Disclaimer.
SNMP	Configure SNMP.
System Recovery	Backup and restore FortiSandbox configurations.
Event Calendar	Show events in a day, week, month, or timeline format.
Event Calendar Settings	Define what kind of events to display in <i>Event Calendar</i> page.
Job View Settings	Define columns and orders of job result tables.
Settings	Configure the idle timeout, the GUI language, the period and ratings to show alarms of unprocessed detections in Notifications on the header bar, the VM external network access, the data storage and password for downloaded files.

Administrators

Use the *Administrators* menu to configure administrator user accounts.

Users with an Admin Profile have Read Only Access privileges under *System > Admin* and can only view and edit their own information.

Only the default admin account can see and access that account. Other users cannot see the default admin account in the GUI. Only administrators with *Super Admin* profile can see all scan jobs, while other users can only see their own jobs.

The following options are available:

Create New	Create a new administrator account.
Edit	Edit the selected administrator account.
Delete	Delete the selected administrator account.
Test Login	Test the selected LDAP/RADIUS/LDAPWILDCARD/RADIUSWILDCARD administrator account's login settings. A detailed debug message display any errors.

The following information is displayed:

Name	Administrator account name.
Type	Administrator type: <ul style="list-style-type: none"> • Local • LDAP • RADIUS • LDAP WILDCARD • RADIUS WILDCARD
Profile	The Admin Profile the user belongs to.

To create a new user:

1. Log in as a user whose Admin Profile has *Full Access* privileges under *System > Admin* , and go to *System > Administrators*.
2. Click *Create New*.
3. Configure the following and click *OK*.

Administrator	Name of the administrator account. <ul style="list-style-type: none"> • <i>Local</i>: Name must be 1 - 30 characters and may contain upper/lower-case letters, numbers, periods (.), underscores (-) and hyphens (-). • <i>LDAP</i> and <i>RADIUS</i>: Name must be 1 - 64 characters and may contain upper/lower-case letters, numbers, periods (.), underscores (-) and hyphens (-).
----------------------	--

Password, Confirm Password	This field is only available when <i>Type</i> is <i>Local</i> . Password of the account. The password must be 6 to 64 characters using uppercase letters, lowercase letters, numbers, or special characters.
Email Address	Email address for contact information.
Phone Number	Phone number for contact information. Phone number must start with <i>+<country code><mobile number></i> .
Admin Profile	Select the Admin Profile for the user: <i>Super Admin, Read Only, Device</i> or <i>Netshare</i> .
Assigned Devices	Assign devices and/or VDOMs/Protected Domains to the user. This applies if your selected Admin Profile has <i>Limited Access > Device User</i> permissions. Click in the <i>Assigned Devices</i> box to display the <i>Available Devices</i> panel which lists all available devices and VDOMs/Protected Domains. Use this panel to select or add devices.
Device Group	You can create device groups in <i>System > Device Groups</i> and then assign them to a device user. Select the Device Group for the user. This applies if the Admin Profile you selected has <i>Limited Access > Device User</i> permissions. You can also assign devices on the fly by selecting self assigned in the Device Group dropdown list. Enable this option to assign devices to the user. When the user logs in, only jobs belonging to the assigned devices or VDOMs/Protected Domains are visible.
Netshare Group	Select the Netshare Group for the user. This applies if the Admin Profile you selected has <i>Limited Access > Netshare User permissions</i> .
Type	Select administrator type.
LDAP	When <i>Type</i> is <i>LDAP</i> , select the <i>LDAP Server</i> . For more information, see LDAP Servers on page 172 .
RADIUS	When <i>Type</i> is <i>RADIUS</i> , select the <i>RADIUS Server</i> . For more information, see RADIUS Servers on page 188 .
LDAP WILDCARD	When <i>Type</i> is <i>LDAP WILDCARD</i> , select the <i>LDAP Server</i> . For more information, see Wildcard Admin Authentication on page 159 .
RADIUS WILDCARD	When <i>Type</i> is <i>RADIUS WILDCARD</i> , select the <i>Radius Server</i> . For more information, see Wildcard Admin Authentication on page 159 .
Two-factor Authentication	When administrator <i>Type</i> is <i>Local</i> , you can use two-factor authentication. Select an <i>Authentication Type</i> of <i>Email, SMS, or FTM</i> (FortiTokenMobile).

	Two-factor Authentication is only available for FortiSandbox appliances, and FSA-VMOT when FortiToken Cloud service is purchased.						
Default On-Demand Submit settings	<p>This option is available to administrators whose <i>Administrator Profile > Scan Job</i> has <i>Read Write</i> access.</p> <p>Use this option to set the default settings in <i>Scan Job > File On-Demand</i> and <i>URL On-Demand</i>. Each administrator can have their own default settings.</p> <table border="1"> <tr> <td>Depth</td> <td>The recursive depth in which URLs are examined. Level 0 for original URL page (between 0 and 5)</td> </tr> <tr> <td>Timeout</td> <td>The time period to stop the URLs scan, in seconds (between 30 and 1200 seconds).</td> </tr> <tr> <td>Direct URL</td> <td>Submit a URL directly without submitting a file.</td> </tr> </table>	Depth	The recursive depth in which URLs are examined. Level 0 for original URL page (between 0 and 5)	Timeout	The time period to stop the URLs scan, in seconds (between 30 and 1200 seconds).	Direct URL	Submit a URL directly without submitting a file.
Depth	The recursive depth in which URLs are examined. Level 0 for original URL page (between 0 and 5)						
Timeout	The time period to stop the URLs scan, in seconds (between 30 and 1200 seconds).						
Direct URL	Submit a URL directly without submitting a file.						
Advanced Options	Select to create passwords, follow the Scan Profile settings or specify the VMs.						
Password(s) for encrypted files	<p>A maximum of 30 passwords is allowed.</p> <p>When upgrading FortiSandbox:</p> <p>If this setting contains more than 30 archive passwords at the time of upgrade, the passwords will continue to work. However, if you save any changes <i>after</i> upgrade, the system will prompt you to limit the number to 30 archive passwords. Editing one user setting will not affect other user's setting.</p>						
Force to scan	Force to scan the file inside VM .						
Allow Interaction	Enable this option to interact with the Windows VM.						
Follow VM Association settings in Scan Profile	If the sandboxing step is not skipped, the file will be sent to its associated VMs defined in the <i>Scan Profile</i> .						
Force to scan inside the following VMs	Overwrite VM association settings in the Scan Profile by selecting one or more of the enabled VMs. If the VM images are not ready, the VM list will not be displayed.						
Record a video	Select to enable video recording. After the scan is finished, a video icon will appear in the <i>File On-Demand</i> second level detail page. Click the icon to trigger a download or play the video.						
Add sample to threat package	If the result matches the malware package requirement, add the scan result to the threat package.						
Submit multiple files	Send multiple files without closing the on-demand pop up window.						
Restrict login to trusted host	Expand to configure trusted hosts.						
Trusted Host #1	Enter up to 50 IPv4 trusted hosts. Only users from trusted hosts can access FortiSandbox.						
Trusted Host #2							

Trusted Host #3	
Trusted IPv6 Host #1	Enter up to 50 IPv6 trusted hosts. Only users from trusted hosts can access FortiSandbox.
Trusted IPv6 Host #2	
Trusted IPv6 Host #3	
Comments	Optional description comment for the administrator account.
Language	GUI language for the user: <i>English, Japanese, or French.</i>



Setting trusted hosts for administrators limits which computers an administrator can log into from FortiSandbox. When you configure a trusted host, FortiSandbox only accepts the administrator's login from the configured IP address or subnet. Any attempt to log in with the same credentials from any other IP address or any other subnet are dropped.

To edit a user account:

1. Log in as a user whose Admin Profile has *Full Access* privileges under *System > Admin* , and go to *System > Administrators*.
2. Select the user you want to edit and click *Edit*.
Only the *admin* account can edit its own settings.
When editing the *admin* account, you must enter the old password before you can set a new password.
3. Edit the account and then retype the new password in the confirmation field.
4. Click *OK*.

To test LDAP/RADIUS user login:

1. Log in as a user whose Admin Profile has *Full Access* privileges under *System > Admin* , and go to *System > Administrators*.
2. Select the LDAP/RADIUS/LDAPWILDCARD/RADIUSWILDCARD user you want to test.
3. Click *Test Login*.
4. In the dialog box, enter the user's password.
5. Click *OK*.
If an error occurs, a detailed debug message appears.



When the remote RADIUS server is configured for two-factor authentication, RADIUS users must enter a Token code from FortiToken/email/SMS. For example, after the user clicks *Login*, the user must enter the Token code, and then click *Submit* to complete the login. The token code is not required when you click *Test login* on the FortiSandbox *Administrators* page

Admin Profiles

Administrator profiles are used to control administrator access privileges to system features. Profiles are assigned to administrator accounts when an administrator is created.

Pre-defined profile types

There are four predefined administrator profiles, which cannot be modified or deleted:

- *Super Admin*: All functionalities are accessible.
- *Read Only*: Can view certain pages. This profile cannot change any system settings.
- *Device*: Can view certain pages for assigned devices. This profile cannot change any system settings.
- *Netshare*: Can view certain pages for assigned network share, and supports *Prioritize Netshare Scan*. This profile cannot change any system settings.

All previous created users in earlier builds are mapped to these four default profiles.

Users require the following permissions to create, edit, and delete administrator profiles:

- Super Admin (see [Pre-defined profile types](#))
- Full Access (see [Data access](#) and [Menu access](#))

Data access

There are two *User Types*:

User type	Description
Full Access	This user type can access all of the data from different submission types.
Limited Access	This user type only can access the data from a Device and/or Netshare group. For more information, see Device Groups on page 160 and Netshare Groups on page 161 .

Menu Access

Full Access	User can view and make changes to the system.	
Read Only	User can only view information.	
None	User cannot view or make changes to the system.	
Dashboard	Status	Grant access to <i>Dashboard > Status</i> .

	Scan Performance	Grant access to <i>Dashboard > Scan Performance</i> . See Scan Performance (dashboard) on page 17.
	Incident Assist	Grant access to <i>Dashboard > Incident Assist</i> . See Incident Assist on page 19.
Security Fabric	Device and FortiClient	Grant access to <i>Security Fabric > Device, FortiClient</i> . See Device on page 31.
	Adapter	Grant access to <i>Security Fabric > Adapter</i> . See Adapter on page 43.
	Network Share	Grant access to <i>Security Fabric > Network Share</i> . See Network Share on page 55.
	Quarantine	Grant access to <i>Security Fabric > Quarantine</i> . See Quarantine on page 60.
	Sniffer	Grant access to <i>Security Fabric > Sniffer</i> . See Sniffer on page 63.
	FortiNDR	Grant access to <i>Security Fabric > FortiNDR</i> . See FortiNDR on page 66.
Scan Job	Job Queue	Grant access to <i>Scan Job > Job Queue</i> . See Job Queue on page 68.
	VM Jobs	Grant access to <i>Scan Job > VM Jobs</i> . See VM Jobs on page 69.
	Scan Searches	Grant access to <i>Scan Job > File Job Search, URL Job Search</i> . See File Job on page 70 and URL Job on page 72.
	Overridden Verdicts	Grant access to <i>Scan Job > Overridden Verdicts</i> . See Overridden Verdicts on page 74.
	On Demand	Grant access to <i>Scan Job > File On-Demand, URL On-Demand</i> . See File On-Demand on page 74 and URL On-Demand on page 80.
	Mark FPN	Allow the profile to override a false positive or negative.
	Download Original File	Enable to download the original file from the Job Detail page. See Appendix B- Job Details page reference on page 244.
	Allow On-Demand Scan Interaction	Enable to use VM interaction during the On-Demand scan or take scan snapshots in the <i>Scan Job > VM Jobs</i> page page.
	Allow On-Demand Scan Video Recording	Allow the profile to take a video during the On-Demand scan and watch it later in the <i>On-Demand</i> page.
	Scan Policy and Object	Scan Configurations

	VM Settings	Grant access to <i>Scan Policy and Object > VM Settings</i> . See, VM Settings on page 116
	Packages	Grant access to <i>Scan Policy and Object > Malware Package, URL Package, TCP RST Package</i> . See Malware Package on page 141 , URL Package on page 142 , and TCP RST package on page 143 .
System	Admin	Grant access to <i>System > Administrator, Admin Profiles, Device Groups, Netshare Groups, Password Policy, LDAP Servers, SAML SSO, RADIUS Servers, Certificates, Netshare Keys</i> . See Administrators on page 152 and Admin Profiles on page 156 .
	Network	Grant access to <i>System > Interfaces, DNS, Static Route</i> .
	Maintenance	Grant access to <i>System > Mail Servers, FortiGuard, Login Disclaimer, SNMP, System Recovery, Settings</i> .
	Event Calendar	Grant access to <i>System > Event Calendar, Event Calendar Settings</i> . See Event Calendar on page 204
	Job View Settings	Grant access to <i>System > Job View Settings</i> . See Job View Settings on page 205 .
	Prioritize Netshare Scan	Grant access to <i>Prioritize Netshare Scan</i> .
	GUI Console	Grant access to <i>System > Console</i> .
HA Cluster		Grant access to the <i>HA cluster settings</i> . See HA cluster on page 210 .
Logs & Reports	Log Events	Grant access to <i>Log & Report > Events > All Events, System Events, VM Events, Job Events, Notification Events</i> . See Log Categories on page 230
	Summary Report	Grant access to <i>Log & Report > Summary Report</i> . See Summary Reports on page 234 .
	Report Center	Grant access to <i>Log & Report > Report Center</i> . See Report Center on page 235 .
	Customize Report	Grant access to <i>Log & Report > Customize Report</i> . See Customize Report on page 236 .
	Network Alerts	Grant access to <i>Log & Report > Network Alerts</i> . See Network Alerts on page 237 .
	Log Servers	Grant access to <i>Log & Report > Log Servers</i> . See Log Servers on page 239 .
	Settings	Grant access to <i>Log & Report > Settings</i> . See Settings on page 206 .

API/CLI Access

Allowed	Enable the setting.
Disallowed	Disable the setting.
Access Setting	Description
JSON API	Grant the profile JSON API privileges.
CLI Commands	Grant privilege for the user to log in via SSH/Telnet.

Wildcard Admin Authentication

You can use wildcard admin authentication to add the RADIUS and LDAP accounts of a group to FortiSandbox all at once instead of adding each account individually.

To add accounts on a RADIUS server:

This example uses FortiAuthenticator as the RADIUS server.

1. On FortiAuthenticator, create the users.
2. If required, create user groups and assign users to the groups.
 - To specify which devices the users have access to, you can define the group's *Attribute ID* as *Fortinet-Group-Name*, and enter a device group name as listed in FortiSandbox as the *Value*. This allows users in this group to view jobs only from the devices inside of that device group.
 - If the *Attribute ID* is not defined, when users log into FortiSandbox, device visibility will follow the device group assigned to the RADIUS_WILDCARD administrator, if any exists.

3. Create a new RADIUS service client.
 - a. Set the client address as the FortiSandbox IP address.
 - b. Enter the secret key in the *Secret* field.

- c. Configure profiles and add the user groups whose users will log into the FortiSandbox.

The screenshot shows the 'Add RADIUS client' configuration page. The 'Name' field is 'fortisandbox'. The 'Client address' is '172.16.69.15'. The 'Secret' field is empty. The 'First profile name' is 'Default'. The 'Description' is 'pwrfta'. The 'Apply this profile based on RADIUS attributes' checkbox is checked. The 'EAP types' section has 'EAP-TLS' checked. The 'Device Authentication' section has 'AD machine authentication' checked. The 'User Authentication' section has 'Apply two-factor authentication if available (authenticate any user)' selected. The 'Username input format' is 'realmusername'. The 'Realms' table shows a realm named 'local | Local users' selected. The 'Groups' dropdown is set to 'Filter'.

4. On FortiSandbox, set up the RADIUS server in *System > RADIUS Servers*. See [RADIUS Servers on page 188](#).
5. Create a new administrator in *System > Administrators*.
 - a. Enter the administrator account name.
 - b. Select *RADIUS WILDCARD* as the type.
 - c. Select the *RADIUS Server* created in the previous step.
 - d. The administrator can be a device user, however, the assigned device group will be overridden if the RADIUS user group has defined the *Attribute ID* as *Fortinet-Group-Name*.

To add accounts on an LDAP server:

1. On the FortiSandbox, set up the LDAP server in *System > LDAP Servers*. See [LDAP Servers on page 172](#). In this example, all users from OU=HQ under the LDAP tree dc=example, dc=org will be able to log into FortiSandbox.
2. Create a new administrator in the *System > Administrators*.
 - a. Enter the administrator account name.
 - b. Select LDAP WILDCARD as the *Type*.
 - c. Select the LDAP server from the previous step.
 - d. Click *OK*.

Device Groups

To simplify the process of assigning devices to users, administrators can add devices to a device group and assign the group to multiple users. Once created, the device group is selectable when modifying an existing user or creating a new device user. When the user logs in, they can only view jobs from the devices included in that device group.



Device groups cannot be deleted while in use by any device user.

To create a device group:

1. Go to *System > Device Groups* and click *Create New*.
2. Enter a group name.
3. Enter a comment to identify this device group if required.
4. Select the devices to be included in the device group.
5. Click *Save*.

The device group is now available to select when modifying or creating a new administrator with device user privileges enabled.



Device groups are also used in LDAP/RADIUS wildcard authentication. See [Wildcard Admin Authentication on page 159](#).

To create a Device admin:

1. Go to *System > Administrator*.
2. Click *Create New*.
3. From the *Admin Profile* dropdown, select *Device*.
4. From the *Device Group* dropdown, select the *Device Group*.
5. Click *OK*.

For more information, see [Administrators on page 152](#)

Netshare Groups

To simplify the process of assigning Network Shares to users, administrators can add Netshares to a Netshare Group and assign the group to multiple users. Once created, the Netshare Group is selectable when modifying an existing or creating a new Netshare user. When the user logs in, they can only view network shares included in that Netshare Group.

To create Netshare Groups:

1. Go to *System > Netshare Groups*.
2. Click *Create New*. The *Netshare Group* page opens.
3. Configure the group settings:

Group Name

Enter a name for the netshare group.

Comment

(Optional) Enter a brief description of the netshare.

NetsharesClick *Select All Netshares* to select all the available netshares or select each netshare individually.

Netshare Group

Group Name: ⚠

Comment:

Netshares:

20WFile

4. Click *Save*.

To create a Netshare admin:

1. Go to *System > Administrator*.
2. Click *Create New*.
3. From the *Admin Profile* dropdown, select *Netshare*.
4. From the *Netshare Group* dropdown, select the *Netshare Group*.
5. Click *OK*.

For more information, see [Administrators on page 152](#).

Password Policy

Allow admin users to configure a user password policy. The new password policy will affect all local administrators.

FortiSandbox allows you to create a password policy for local administrators. With this policy, you can enforce regular changes and specific criteria for a password policy including:

- The minimum character requirements. Such as requirements for numbers, uppercase and special characters.
- The number of days a password is set to expire for all local administrators.
- If the new password must be unused.

If you add a password policy or change the requirements on an existing policy, users that are already logged into FortiSandbox may have their session interrupted to update the password to meet the new policy.

Otherwise, the next time an administrator logs into the FortiSandbox via GUI/SSH/Telnet, the local administrator is prompted to update the password to meet the new requirements before proceeding to log in.

To create a password policy:

1. Go to *System > Password Policy*.
2. Click *Enable*. The *User Password Policy* page expands.
3. Configure the password policy.

Minimum password length	Enter the minimum number characters the password must contain. The default is 6.								
Minimum character requirements	Enable to specify the number required characters. <table border="1" data-bbox="587 596 1451 940"> <tr> <td>Lower case</td> <td>Enter the required number of lowercase characters. The default is 0.</td> </tr> <tr> <td>Upper case</td> <td>Enter the required number of uppercase characters. The default is 0.</td> </tr> <tr> <td>Non-alphanumeric</td> <td>Enter the required number of Non-alphanumeric characters. The default is 0.</td> </tr> <tr> <td>Numeric</td> <td>Enter the required number of numeric characters. The default is 0.</td> </tr> </table>	Lower case	Enter the required number of lowercase characters. The default is 0.	Upper case	Enter the required number of uppercase characters. The default is 0.	Non-alphanumeric	Enter the required number of Non-alphanumeric characters. The default is 0.	Numeric	Enter the required number of numeric characters. The default is 0.
Lower case	Enter the required number of lowercase characters. The default is 0.								
Upper case	Enter the required number of uppercase characters. The default is 0.								
Non-alphanumeric	Enter the required number of Non-alphanumeric characters. The default is 0.								
Numeric	Enter the required number of numeric characters. The default is 0.								
Enable password expiration (days)	Enable to enter the number of days is set to expire. The default is 90 days,								
Allow password reuse	Allow the user to reuse an old password. This option is enabled by default.								

User Password Policy

Enable Password Policy Enable Disable

Minimum password length

Minimum character requirements

Enable password expiration (days)

Allow password reuse

4. Click *Apply*.



- The *Notifications* icon in FortiSandbox will alert administrators the password will expire seven days before the expiration date
- The password policy is also applied to following related features:
 - Maintainer account login FSA to reset the built-in admin's password. For more information, see the Best Practices Guide > [Resetting user's admin password](#).
 - Using CLI to create a new administrator.
 - The Json API function 33 Configure system administrator.

Password Best Practices

Brute force password software can launch more than just dictionary attacks. It can discover common passwords where a letter is replaced by a number. For example, if *p4ssw0rd* is used as a password, it can be cracked.

Using secure passwords is vital to preventing unauthorized access to your FortiSandbox. When changing the password, consider the following to ensure better security:

- Do not use passwords that are obvious, such as the company name, administrator names, or other obvious words or phrases.
- Use numbers in place of letters, for example: *passw0rd*.
- Administrator passwords can be up to 64 characters.
- Include a mixture of numbers, symbols, and upper and lower case letters.
- Use multiple words together, or possibly even a sentence, for example: *correcthorsebatterystaple*.
- Use a password generator.
- Change the password regularly and always make the new password is unique and not a variation of the existing password. For example, do not change from *password* to *password1*.
- Make note of the password and store it in a safe place away from the management computer, in case you forget it; or ensure at least two people know the password in the event one person becomes unavailable. Alternatively, have two different admin logins.

Interfaces

To view and manage interfaces, go to *System > Interfaces*.

This page displays the following information and options:

Interface	The interface name and description, where applicable. The failover IP includes the description: (<i>cluster external port</i>).
port1 (administration port)	port1 is hard-coded as the administration interface. You can enable or disable HTTP, SSH, or Telnet access rights on port1. HTTPS is enabled by default. You can use port1 for Device mode, although a different, dedicated port is recommended.
port2	You can use port2 for Sniffer mode, Device mode, or inter-node communication within a cluster.
port3 (VM outgoing interface)	port3 is reserved for outgoing communication triggered by the execution of the files under analysis.

FortiSandbox uses port3 to allow scanned files to access the Internet. The Internet visiting behavior is an important factor to determine if a file is malicious. As malicious files are infectious, ensure that the connection for port3 is isolated but can also access the Internet. Do not allow this connection to belong to or be able to access any internal subnet that needs to be protected. Fortinet recommends placing this interface on an isolated network behind a firewall.

FortiSandbox VM accesses external networks through port3. Configure the next hop gateway and DNS settings in *System > Settings > VM External Network Access*. This allows files running inside VMs to access the external network. One special type of outgoing communication from a guest VM is to connect to the Microsoft activation server to activate the Windows Sandbox VM product keys. Office licenses are verified through VM machines so internet access via port3 is required to contact Microsoft for license activation.

If the VM cannot access the outside network, a simulated network (SIMNET) starts by default. SIMNET provides responses to popular network services like http where some malware is expected. If the VM internet access is down, the SIMNET status is displayed beside the down icon. Click that icon to go to the VM network configuration page.



SIMNET is not a real internet. This can affect catch rate. Do not use an IP address from the production IP pool for the IP assignment on port3 because it might get put on the blocklist.

port4

You can use port4 for Sniffer mode, Device mode, or inter-node communication within a cluster.

port5/port6

You can use port5 and port6 for Sniffer mode, Device mode, or inter-node communication within a cluster.

We recommend using port5 and port6 of FortiSandbox devices with 10G fiber ports for primary or secondary node as communications ports with cluster workers.

port7/port8

You can use port7 and port8 for Sniffer mode, Device mode, or inter-node communication within a cluster.

IPv4

IPv4 IP address and subnet mask of the interface.

IPv6

IPv6 IP address and subnet mask of the interface.

Interface Status

State of the interface:

- Interface is up
- Interface is down
- Interface is being used by sniffer

Link Status

Link status:

- Link up
- Link down

Access Rights	Access rights associated with the interface. HTTPS is enabled by default on port1 and any other administrative port set by the CLI command <code>set admin-port</code> . You can select to enable HTTP, SSH, and Telnet access on the administrative port. Ensure <i>HTTPS</i> is enabled for the port used to receive files via the Inline Block policy.
PCAP	Click the PCAP icon to sniff the traffic of an interface for up to 60 seconds. Click <i>Capture & Download</i> to download the PCAP file as a zip file. Maximum file size is 100MB file size. You can define the tcpdump filter such as host 172.10.1.1 or TCP port 443. You can only run one capture at a time for each port. Sniffing ports are combined and treated as a single port.
Create New	Create an interface.
Edit	Edit the selected interface.

For more information, see [Port and access control information](#) in the *FortiSandbox Getting Started Guide*.

To set up more administration ports, use the CLI command `set admin-port`.

The following subnets are reserved by FortiSandbox. Do not configure interface IP addresses in this range.

192.168.56.0/24
192.168.57.0/24
192.168.250.0/24

Edit an interface

Do not change settings on an interface used for sniffing traffic.

To edit an IPv4 or IPv6 address:

1. Go to *System > Interfaces*.
2. Select an interface and click *Edit*.
3. Edit the IP address.
4. To change the *Interface Status*, click its icon.
5. Click *OK*.

Edit administrative access

Administrative access rights can only be set on port1. All other administrative ports follow port1 settings.

The port1 interface or any other administrative port set through the CLI command `set admin-port` is used for administrative access to FortiSandbox. HTTPS is enabled by default. You can edit this interface to enable HTTP, SSH, and Telnet support.

To edit administrative access:

1. Go to *System > Interfaces*.
2. Select an administrative interface and click *Edit*.
3. Edit the IP address.
4. To change the *Interface Status*, click its icon.
5. Select the *Access Rights* for *HTTP*, *SSH*, and *Telnet*.
6. Click *OK*.

Create an aggregate interface

You can create an interface that uses IEEE 802.3ad to bind multiple physical networks to form an aggregated, combined link. The aggregate link has the bandwidth of the combined links. If one interface in the group fails, traffic is automatically transferred to the other interfaces. The only noticeable effect is reduced bandwidth.

In *System > Interfaces*, a network interface that is part of an aggregate link is displayed in gray. You cannot configure the interface individually.

A network interface must meet all the following conditions to be added to an aggregate interface:

- It is not already part of an aggregate interface.
- It does not have the same IP address as another interface.
- It is not an administration port.
- It is not a VM outgoing port.
- It is not a sniffer port.
- It is not an HA cluster communication port.

To create an aggregate interface:

This example creates an aggregate interface on ports 4 - 6 with an internal IP address of 10.1.1.123 with administrative access to HTTPS and SSH.

1. Go to *System > Interfaces* and click *Create New*.
FortiSandbox sets the *Name* as *bond{n}* and the *Type* as *802.3ad Aggregate*.
2. For *Interface Member*, select the physical interface members. In this example, select ports 4, 5, and 6.
3. Enter the IPv4 IP address for the port. In this example, enter *10.1.1.123/24*.

4. If necessary, enter the IPv6 IP address.

New Interface

Name:	bond1
Type:	802.3ad Aggregate
Interface Member:	<input checked="" type="checkbox"/> port4 <input checked="" type="checkbox"/> port5 <input checked="" type="checkbox"/> port6

IP Address / Netmask

IPv4/Netmask:	10.1.1.123/24
IPv6/Prefix:	

OK
Cancel

5. Click *OK* to display the created bond.

Interface	IPv4	IPv6	Interface Status	Link Status	Access Rights	PCAP
bond1	10.1.1.123/255.255.255.0		⬆	■		
port1 (administration port)	10.1.1.127/255.255.255.0		⬆	■	HTTPS,HTTP,SSH,TELNET	⬇
port2	10.1.1.127/255.255.255.0		⬆	■		⬇
port3 (VM outgoing port)	10.1.1.127/255.255.255.0		⬆	■		⬇
port4			⊞	■		
port5			⊞	■		
port6			⊞	■		

6. Use the CLI command `show` to display the bond information. For example:

```
Bond 1 IPv4 IP: 10.1.1.123/24 MAC: xx:xx:xx:xx:xx:xx
MTU: 1500
Slave Interface: port4 port5 port6
```

7. Use the following CLI command to add *bond1* as the administration port.

```
set admin-port bond1
```

`System > Interfaces` shows that *bond1* has the same access rights as *port1*.

When you change the *port1* access rights, the *bond1* access right is automatically synchronized.

Interface	IPv4	IPv6	Interface Status	Link Status	Access Rights
bond1 (administration port)	10.1.1.123/255.255.255.0		⬆	■	HTTPS,HTTP,SSH,TELNET
port1 (administration port)	10.1.1.127/255.255.255.0		⬆	■	HTTPS,HTTP,SSH,TELNET
port2 (administration port)	10.1.1.127/255.255.255.0		⬆	■	HTTPS,HTTP,SSH,TELNET
port3 (VM outgoing port)	10.1.1.127/255.255.255.0		⬆	■	
port4			⊞	■	
port5			⊞	■	
port6			⊞	■	

To set the aggregate interface as the administration port, use the CLI command `set admin-port bond1`.

To change the MTU of an aggregate interface, use the `set port mtu` CLI command. For example, `set port-mtu bond1 1200`.

Additional information

- LACP supports static mode only.
- There is no CLI command to create or delete the LACP 802.3ad interface.
- The bond interface does not support PCAP.
- You cannot delete an admin LACP bond.
- You cannot add a new interface to an existing bond.
- You cannot remove an interface member from an existing bond.
- For FortiSandbox VM, including KVM, Hyper-V, AWS, and Azure, implement the LACP support on the virtual server first, then create the aggregate interface.

Failover IP

Users are able to configure a cluster level failover IP, which will be set only on primary node. This failover IP can only be set on current primary node through the CLI. It should be in the same subnet of the port's local IP. Clients, such as FortiGates, should point to the failover IP in order to use the HA functionality. When a failover occurs, failover IP will be applied on new primary node.

The primary and secondary node local IP will be kept locally during failover.

Example

Here is an example to set a failover IP for port1.

```
> show
Configured parameters:
Port 1 IPv4 IP: 172.16.69.145/24 MAC: 14:18:77:52:37:72
Port 1 IPv6 IP: 2620:101:9005:69::145/64 MAC: 14:18:77:52:37:72
Port 2 IPv4 IP: 1.1.7.5/24 MAC: 14:18:77:52:37:73
Port 3 IPv4 IP: 192.168.199.145/24 MAC: 14:18:77:52:37:74
IPv4 Default Gateway: 172.16.69.1
> hc-settings -sc -tM -n145 -cdemo-cluster -p1234 -iport2
The unit was successfully configured.
> hc-settings -si -iport1 -a172.16.69.160/24
The external IP address 172.16.69.160 for cluster port1 was set successfully
> hc-settings -l
SN: FSA3KE3R17000243
Type: Master
Name: 145
HC-Name: demo-cluster
Authentication Code: 1234
Interface: port2
Cluster Interfaces:
port1: 172.16.69.160/255.255.255.0
```

Create an API Interface

You can create an interface that only allows API access through HTTPS port.

Before you create the API interface, be aware that you cannot:

- Set or unset API port with the GUI (CLI only)
- Login to to the API port with the GUI (access will be denied)
- View the api-port in Sniffer settings
- Access the API port through HTTP
- Set the api-port interface as an admin port or HA port
- Set admin-port, port3, sniffer port, or HA port as an api-port

To display the API information with the CLI:

```
show
```

Example

```
IPv4 Default Gateway: 10.59.4.1
Administration interface(s): port1 bond1
(s): port2
```

API interface

To add an API port with the CLI:

```
set api-port port2
```

To unset an API port with the CLI:

```
unset api-port port2
```

To view an API interface in the GUI:

1. Go to *System > Interfaces*.
2. In the *Interface* column, the port is appended with *API port*.

DNS Configuration

The primary and secondary DNS server addresses can be configured from *System > DNS*. FortiSandbox is configured to use the FortiGuard DNS servers by default.

Static Route

Use this page to manage static routes on your FortiSandbox device. Go to *System > Static Route* to view the routing list.

The following options are available:

Create New	Select to create a new static route.
Edit	Select a static route in the list and click <i>Edit</i> in the toolbar to edit the entry.
Delete	Select a static route in the list and click <i>Delete</i> in the toolbar to delete the entry.

The following information is displayed:

IP/Mask	Displays the IP address and subnet mask.
Gateway	Displays the gateway IP address.
Device	Displays the interface associated with the static route.
Number of Routes	Displays the number of static routes configured.

To create a new static route:

1. Click *Create New* from the toolbar.
2. Enter a destination IP address and mask, and a gateway, in their requisite fields.



The destination IP/Mask can be entered in the format 192.168.1.2/255.255.255.0, 192.168.1.2/24, or fe80:0:0:0:0:c0a8:1fe.

The following subnets are reserved for use by FortiSandbox. Do not configure static routes for these IP address ranges:

- 192.168.56.0/24
- 192.168.57.0/24
- 192.168.250.0/24

3. Select a device (or interface) from the dropdown list.
4. Click *OK* to create the new static route.

To edit a static route:

1. Select a Static Route.
2. Click the *Edit* button.
3. Edit the destination IP address and mask, gateway, and device (or interface) as required.
4. Click *OK* to apply the edits to the static route.

To delete a static route or routes:

1. Select one or more Static Routes.
2. Click the *Delete* button from the toolbar.
3. Select *Yes, I'm sure* on the confirmation page to delete the selected route or routes.



Static route entries defined in this page are for system use and are not applied to traffic originating from the guest VM during a file's execution.

LDAP Servers

The FortiSandbox system supports remote authentication of administrators using LDAP servers. To use this feature, configure the server entries in the FortiSandbox unit for each authentication server in your network.

If you have configured LDAP support and require a user to authenticate using an LDAP server, the FortiSandbox unit contacts the LDAP server for authentication. To authenticate with the FortiSandbox unit, the user enters a user name and password. The FortiSandbox unit sends this user name and password to the LDAP server. If the LDAP server can authenticate the user, the FortiSandbox unit accepts the connection. If the LDAP server cannot authenticate the user, the FortiSandbox unit refuses the connection.

The following options are available:

Create New	Add an LDAP server.
Edit	Edit the selected LDAP server.
Delete	Delete the selected LDAP server.

The following information is displayed:

Name	LDAP server name.
Address	LDAP server IP address.
Common Name	LDAP common name.
Distinguished Name	LDAP distinguished name.
Bind Type	LDAP bind type.
Connection Type	LDAP connection type.

To create a new LDAP server:

1. Go to *System > LDAP Servers*.
2. Click *Create New*.

3. Configure the following settings.

Name	LDAP server name. Use a name unique to FortiSandbox.
Server Name/IP	LDAP server IP address or fully qualified domain name.
Port	Port for LDAP traffic. LDAP default port is 389. LDAPS default port is 636.
Common Name Identifier	LDAP common name. Most LDAP servers use cn. Some servers use other common name identifiers such as uid.
Distinguished Name	LDAP distinguished name used to look up entries on the LDAP server. The distinguished name reflects the hierarchy of LDAP database object classes above the common name identifier. For example, you can follow the format CN=Users,DC=Example,DC=Com.
Bind Type	LDAP bind type for authentication, including: <ul style="list-style-type: none"> • Simple • Anonymous • Regular
Username	If <i>Bind Type</i> is <i>Regular</i> , enter the user distinguished name.
Password	If <i>Bind Type</i> is <i>Regular</i> , enter the password.
Secure Connection	LDAP connection type.
Protocol	If <i>Secure Connection</i> is enabled, select <i>LDAPS</i> or <i>STARTTLS</i> .
CA Certificate	If <i>Secure Connection</i> is enabled, select the CA certificate.
Advanced Options	Expand to configure advanced options.
Attributes	Attributes such as <i>member</i> , <i>uniquemember</i> , or <i>memberuid</i> .
Connect timeout	Connection timeout in milliseconds. Default is 500.
Filter	Filter in the format such as (&(objectClass=*)).
Group	Name of the LDAP group. For example, you can follow the format CN=Group1,DC=Example,DC=Com.
Memberof-attr	Specify the value for this attribute. This value must match the attribute of the group in LDAP server. All users of the LDAP group with the attribute matching the <i>memberof-attr</i> inherit the administrative permissions of the group.
Profile-attr	Specify the attribute for this profile.
Secondary-server	Specify a secondary server for failover in case the primary LDAP server fails. The <i>Distinguished Name</i> must be the same.
Tertiary-server	Specify a tertiary server for failover in case the primary and secondary servers fail. The <i>Distinguished Name</i> must be the same.

4. (Optional) Test the connection.

- a. Click *Test Login* to verify the account can login successfully.
- b. If the log in fails, click *Test Connectivity* to check the connection.

5. Click *OK*.

SAML SSO

Security Assertion Markup Language (SAML) is an open standard for exchanging authentication and authorization data between one Identity Provider (IdP) and one or more Service Providers (SP). Both parties exchange messages using the XML protocol as transport.

When SSO is enabled, you can configure Microsoft Entra ID (Azure AD) or FortiAuthenticator to be the Service Provider. Users created with the IdP for SAML can log into FortiSandbox to be authenticated and authorized. After authentication, the user does not need to provide their credentials again, as long as the admin is using the same browser session.

The first time an SSO user logs in, FortiSandbox automatically creates a new SSO administrator to store the user.



The SAML attributes configured on FortiSandbox (e.g., *username*) can be customized, however they must align with the corresponding attributes set on the IdP server.

SAML SSO	
Enable SSO	Click to <i>Enable</i> or <i>Disable</i> SAML SSO.
SP Entity ID	Service Provider (SP) entity ID.
SP Login URL	SP login URL (Assertion Consumer Service, ACS).
SP Logout URL	SP logout URL (Single Logout Service, SLS).
SP Metadata	Click the <i>Download</i> button to download SP metadata.
SP Certificate	Certificate used by the SP in SAML authentication.
IdP Settings	
Import IdP Metadata	Click to import metadata from the Identity Provider (IdP).
IdP Entity ID	IdP entity ID.
IdP Login URL	IdP login endpoint where authentication requests are sent.
IdP Logout URL	IdP logout endpoint where logout requests are sent.
IdP Certificate	Certificate used by the IdP in SAML authentication.
User Profile	
Let IdP determine user's profile when logging in	Toggle to allow IdP to assign a user profile during login. The following fields appear when this setting is enabled.

Attribute used to identify admin profile	This is a required field and cannot be empty.
Reject login if not able to determine user's profile	Toggle to reject login if the user's profile cannot be determined.
Default profile	This field appears when <i>Reject login if not able to determine user's profile</i> is disabled. The default value is <i>Read-Only</i> .

User Account Information

Attribute for obtaining user's username	SAML attribute mapped to the username. This is a required field and cannot be empty.
Attribute for obtaining user's trusted host configuration	SAML attribute mapped to the user's trusted host configuration.
Attribute for obtaining user's email address	SAML attribute mapped to the user's email.
Attribute for obtaining user's phone number	SAML attribute mapped to the user's phone number.

SAML SSO login FortiSandbox with Microsoft Entra ID acting as SAML IdP

In this example, users are managed through Microsoft Entra ID. The FortiSandbox is configured for SSO with authentication performed by the Azure AD as a SAML identity provider (IdP).

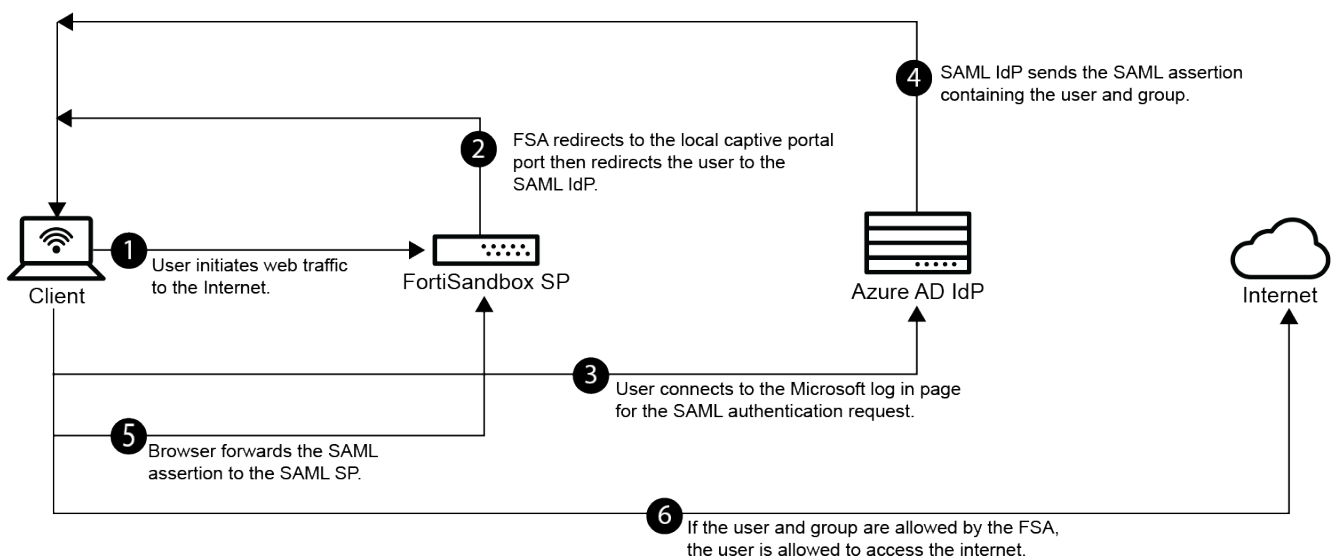

Configuring the Microsoft Entra ID

The following Entra ID configuration demonstrates how to add the FortiSandbox as an enterprise non-gallery application. This application provides SAML SSO connectivity to the Entra ID IdP. Some steps are performed concurrently on the FortiSandbox.



This example is configured with an Entra ID free-tier directory. There may be limitations to managing users in Azure in this tier that are not limited in other tiers. Consult the Microsoft Entra ID documentation for more information.

To configure Entra ID:

1. Create a new enterprise application.
2. Configure the SAML SSO settings on the application and FortiSandbox.
3. Assign Entra ID users and groups to the application.

Create a new enterprise application

To create a new enterprise application:

1. Log in to the Azure portal.
2. In the Azure portal menu, click *Microsoft Entra ID*.
3. In the left navigation pane menu go to *Manage > Enterprise applications*.
4. Click *New application*.

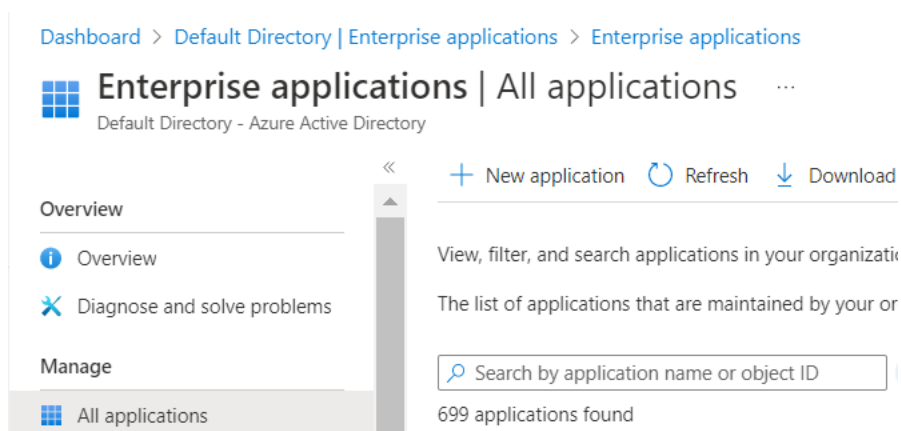

5. Click *Create your own application*.

Dashboard > Default Directory | Enterprise applications > Enterprise applications | All applications >

Browse Azure AD Gallery

+ Create your own application | Got feedback?

6. Enter a name for the application and select *Integrate any other application you don't find in the gallery (Non-gallery)*.

Create your own application



Got feedback?

If you are developing your own application, using Application Proxy, or want to integrate an application that is not in the gallery, you can create your own application here.

What's the name of your app?

What are you looking to do with your application?

- Configure Application Proxy for secure remote access to an on-premises application
- Register an application to integrate with Azure AD (App you're developing)
- Integrate any other application you don't find in the gallery (Non-gallery)

7. Click *Create*.

Configure the SAML SSO settings on the application and FortiSandbox



This task requires going back and forth between Azure and the FortiSandbox GUI. We recommend keeping the FortiSandbox GUI open for the entire procedure.

To configure the SAML SSO settings on the application and FortiSandbox

1. On the *Enterprise Application* overview page, go to Manage > Single sign-on and select SAML as the single sign-on method.

Enterprise Application

- Overview
- Deployment Plan
- Diagnose and solve problems

Manage

- Properties
- Owners
- Roles and administrators
- Users and groups
- Single sign-on

- Click *Edit* of Section 1 (Basic SAML Configuration)

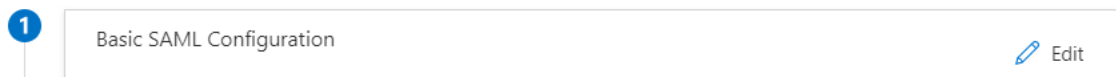

- Keep the Azure Portal open and in FortiSandbox go to *System > SAML SSO* and click *Enable* next to *Enable SSO*.
- In Azure go to *Set up Single Sign-On with SAML > Edit Section 1* and copy the following URLs from the FortiSandbox to the *Basic SAML Configuration* section:

From FortiSandbox	To Azure field
SP Entity ID (https://10.1.0.1/sso_sp)	Identifier (Entity ID)
SP login URL (https://10.1.0.1/sso_sp/op/?acs)	Reply URL and Sign on URL
SP logout URL (https://10.1.0.1/sso_sp/op/?s1s)	Logout URL

Basic SAML Configuration

Identifier (Entity ID)	https://	/sso_sp
Reply URL (Assertion Consumer Service URL)	https://	/sso_sp/op/?acs
Sign on URL	https://	/sso_sp/op/?acs
Relay State (Optional)	Optional	
Logout Url (Optional)	https://	/sso_sp/op/?s1s



If you are deploying FortiSandbox or FortiAuthenticator on a public cloud you will need to update the Public IP to Private IP manually. Otherwise, the URLs will not work.

- Click *Save*.
- Edit *Section 2 (Attributes & Claims) > Add new claim*.

Attributes & Claims ...

+ Add new claim + Add a group claim

- Configure the new claim:

Claim	Value
Name	username

Claim	Value
Namespace	Leave blank
Source	Attribute
Source attribute	user.userprincipalname

Attributes & Claims

givenname	user.givenname
surname	user.surname
emailaddress	user.mail
name	user.userprincipalname
username	user.userprincipalname
Unique User Identifier	user.userprincipalname

- Click the Save button to add this new claim.
- Click the close button (X) at the top-right to return.
- In *Section 3 (SAML Certificates)*, download the *Certificate (Base64)*.

3 SAML Certificates

Token signing certificate		 Edit
Status	Active	
Thumbprint	C3FCC91A56C22AA91209C02B7CF54666F60645B3	
Expiration	12/2/2025, 4:34:57 PM	
Notification Email	@fortinet-us.com	
App Federation Metadata Url	<input type="text" value="https://login.microsoftonline.com/942b80cd-1b14..."/>	
Certificate (Base64)	Download	
Certificate (Raw)	Download	
Federation Metadata XML	Download	

- To import this certificate into FortiSandbox, go to *System > Certificates*.
- On FortiSandbox, go to *System > SSO* to configure the SSO settings. Copy the following URLs from *Entra ID SAML-based Sign-on > Section 4* page:

From Azure	To FortiSandbox field
Microsoft Entra Identifier	IdP Entity ID
Login URL	IdP login URL
Logout URL	IdP logout URL

- For *IdP certificate*, choose the certificate you imported earlier.
- Click *OK*, to save you settings to FortiSandbox.

Assign Entra ID users and groups to the application

To assign Entra ID users and groups to the application:

1. In Azure, go to *Manage > Users and groups* and click *Add user/group*.

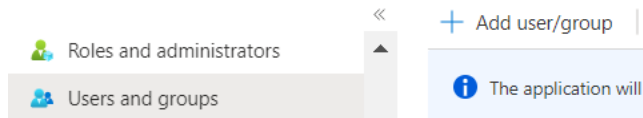

2. Select the users or groups.

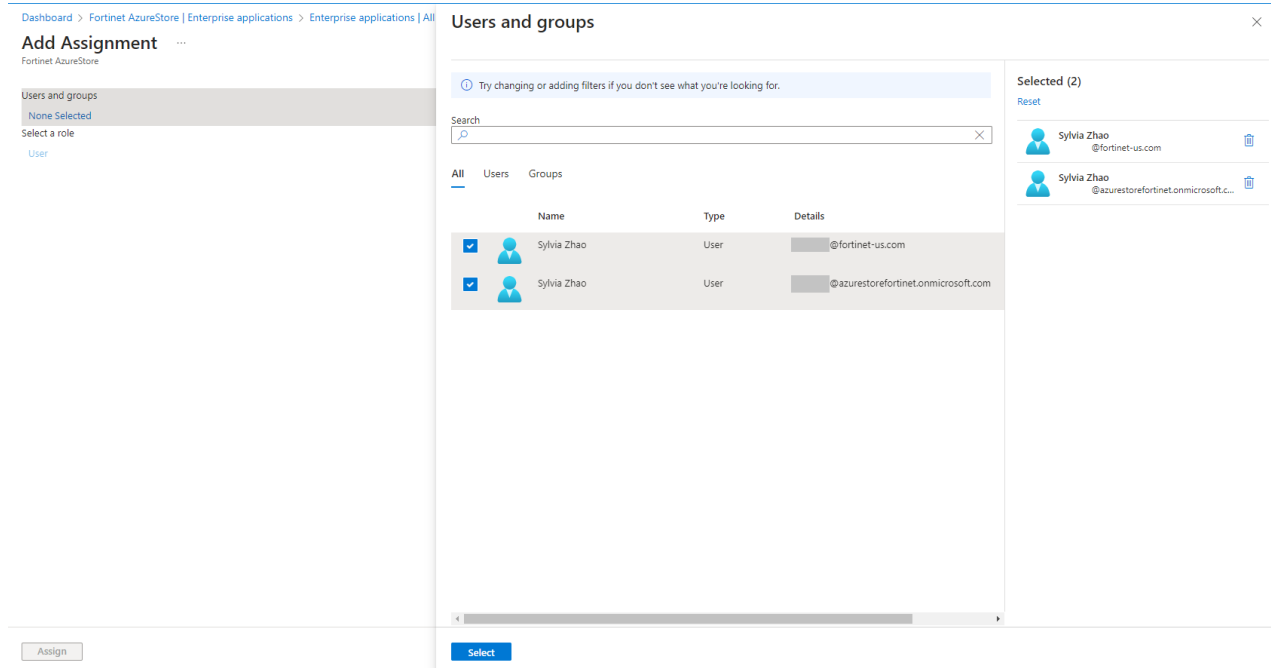

Connecting from the client

When the client connects to the internet from a browser, they will be redirected to the Microsoft login page to authenticate against the Entra ID (formerly Azure AD). The FortiSandbox authentication portal certificate should be installed on the client.

To connect from the client with Azure Account:

1. On the client, open a browser (such as Firefox) and enter FortiSandbox IP. On the FortiSandbox login page, click *Login with Single Sign-On*.

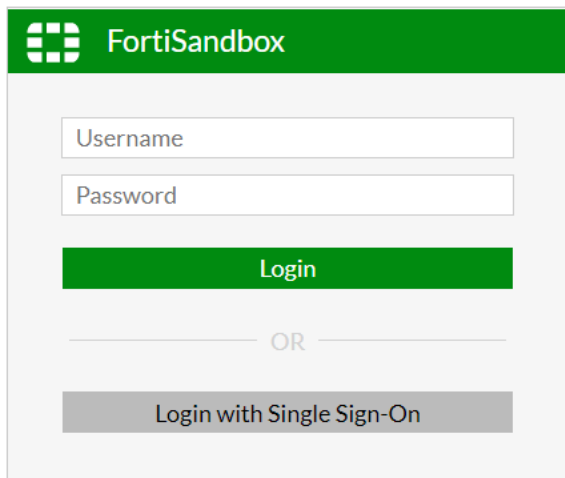

The image shows the FortiSandbox login interface. It features a green header with the FortiSandbox logo and name. Below the header are two input fields: 'Username' and 'Password'. A green 'Login' button is positioned below the password field. Below the 'Login' button is a horizontal line with the text 'OR' in the center. At the bottom of the form is a grey button labeled 'Login with Single Sign-On'.

2. You are redirected to the Microsoft login page

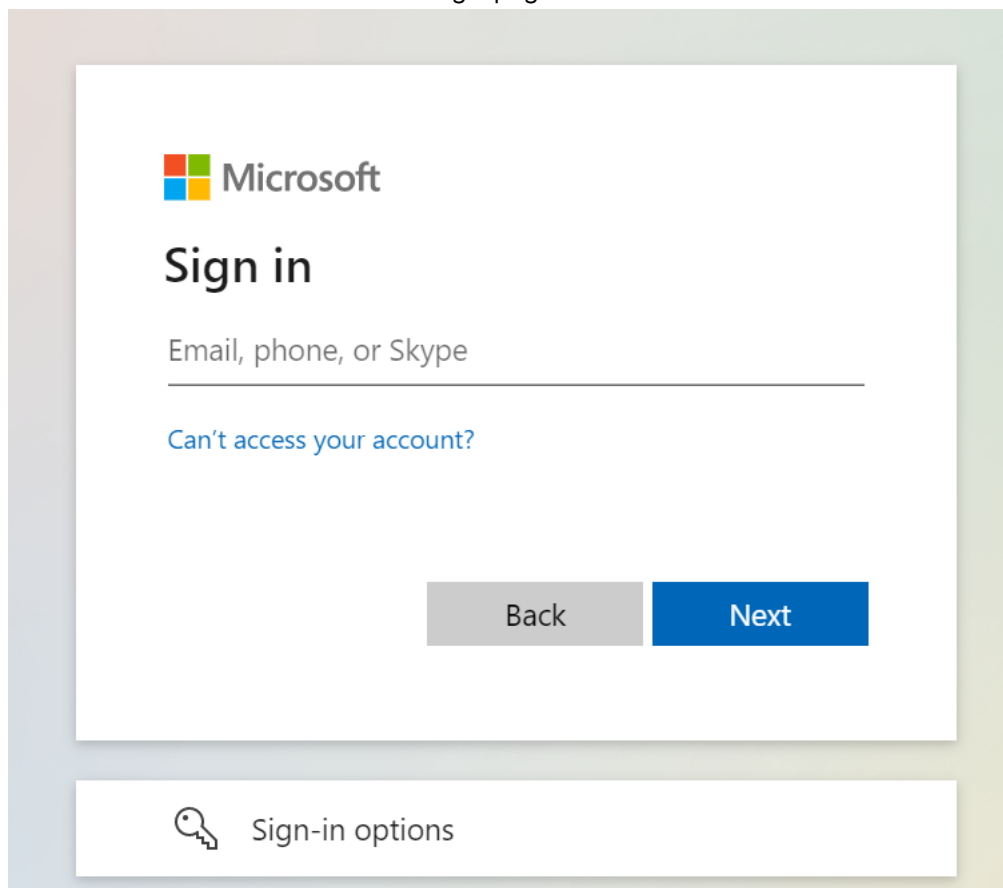

The image shows the Microsoft Sign in page. It features the Microsoft logo at the top left. Below the logo is the text 'Sign in'. Underneath is a text input field with the placeholder text 'Email, phone, or Skype'. Below the input field is a blue link that says 'Can't access your account?'. At the bottom right of the main content area are two buttons: a grey 'Back' button and a blue 'Next' button. At the bottom of the page is a white box with a key icon and the text 'Sign-in options'.

3. Enter the user credentials of Azure Account to login FortiSandbox as a FortiSandbox SSO administrator





The first time the user logs in, FortiSandbox will automatically create an SSO administrator with default built-in *read-only* admin profile. The administrators with *read-write* access are allowed to update SSO administrators. For more information about profiles, see [Admin Profiles on page 156](#).

SAML SSO login FortiSandbox with FortiAuthenticator acting as SAML IdP

FortiSandbox can act as a SAML service provider (SP) that requests authentication from a FortiAuthenticator, which acts as a SAML identity provider (IdP). The FortiAuthenticator also acts as a root CA to sign certificates for the SP and IdP.

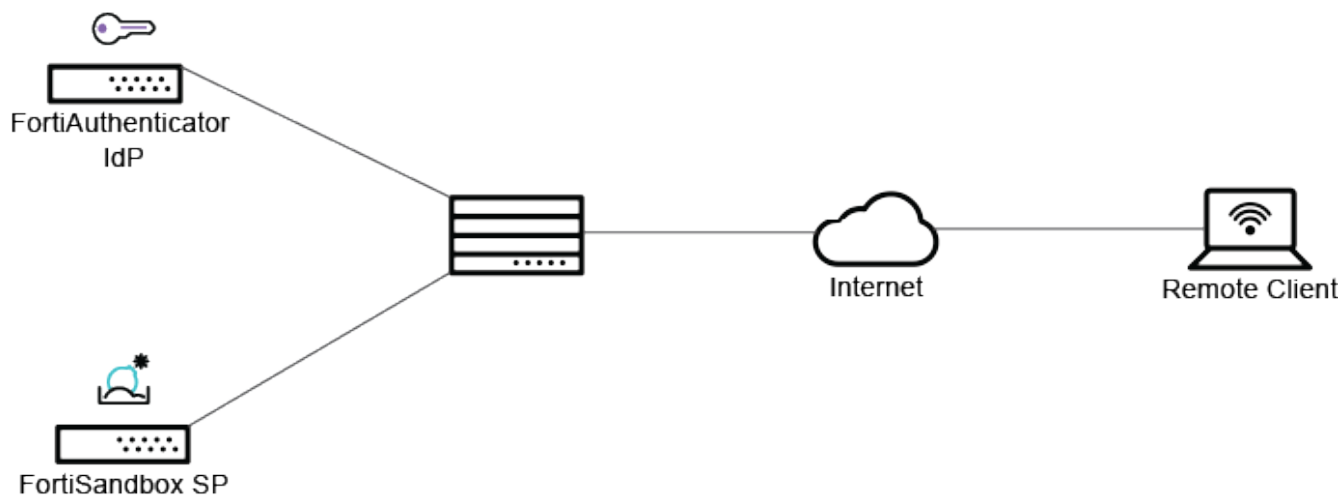

1. [Configuring the FortiAuthenticator on page 182](#)
2. [Connecting from the client with a FortiAuthenticator user on page 186](#)

Configuring the FortiAuthenticator

This section provides steps for configuring Security Assertion Markup Language (SAML) authentication using FortiAuthenticator for FortiSandbox solutions.



This section includes configuration information for the SAML authentication using FortiAuthenticator for FortiSandbox only. For more information about the setup and configuration of the FortiAuthenticator, see the *FortiAuthenticator Administration Guide* on the [Fortinet Documents Library](#).

To configure FortiAuthenticator:

1. [Create a new SSO user.](#)
2. [Configure FortiAuthenticator IdP and export the IdP certificate.](#)

3. Configure SP settings on FortiAuthenticator.
4. Configure SAML SSO settings on FortiSandbox.

Create a new SSO user

To create a new SSO user on FortiAuthenticator:

1. Go to *Authentication > User Management > Local Users*, and click *Create New*.
2. Enter a username and password for the local user.
3. Disable *Allow RADIUS authentication*.

4. Click *OK* to save changes to the local user

Configure FortiAuthenticator IdP and export the IdP certificate

To configure FortiAuthenticator IdP:

1. Go to *Authentication > SAML IdP > General*.
2. Enable SAML Identity Provider portal, and enter the following information:

Server address	Enter the device FQDN of the FortiAuthenticator IdP.  When FortiSandbox and FortiAuthenticator are accessed by assigned external public IPs, the Server address should be the FortiAuthenticator public IP.
Username input format	Select the default username input format. The default is <code>username@realm</code> .
Realms	In the dropdown, select the local realm. Optionally, for group filtering, enable <i>Filter</i> , click the pen icon to edit, select groups from the <i>Available User Groups</i> search box, and click <i>OK</i> .
Default IdP certificate	Select a default certificate to use in your SAML configuration. The certificate is used in the https connection to the IdP portal.

3. Click *OK*.

Once the IdP has been configured, you can proceed with setting up the service provider(s) of your choice.

In addition to configuring the SAML IdP settings, you will also need to select and export the default IdP certificate for use on the service providers.

To export the IdP certificate in FortiAuthenticator:

1. Go to *Certificate Management > End Entities > Local Services*.
2. Select the certificate used in the SAML IdP and click *Export Certificate*.

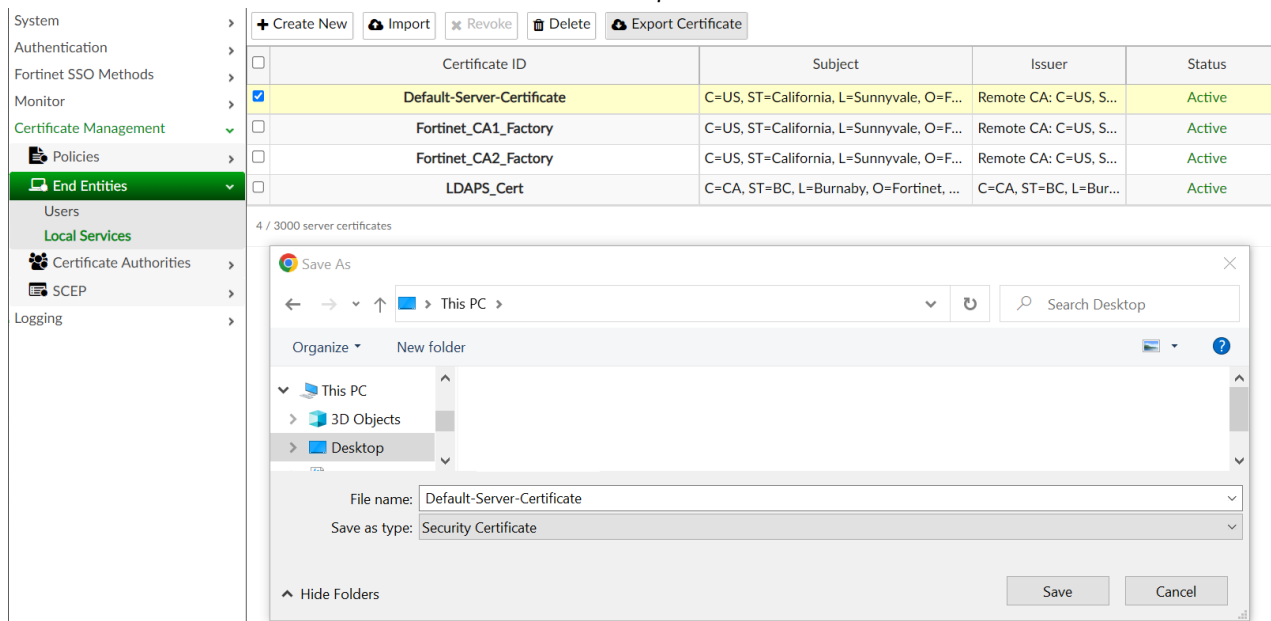

Configure the SP settings on FortiAuthenticator

To complete the following configuration, you will need to configure the SAML settings on the SP device at the same time. This is because some fields including the SP entity ID, SP ACS URL, and SP SLS URL are only available when configuring the SAML settings on the SP device.

To configure service provider settings on the FortiAuthenticator:

1. Go to *Authentication > SAML IdP > Service Providers*, and click *Create New*.
2. Enter the following information:

SP name	Enter a name for the SP device.
IDP prefix	Select + , and enter an IdP prefix in the <i>Create Alternate IdP Prefix</i> dialog or select <i>Generate prefix</i> , and click <i>OK</i> .
Server certificate	Select the same certificate as the default IdP certificate used in <i>Authentication > SAML IdP > General</i> . Enable <i>Participate in single logout</i> to send logout requests to this SP when the user logs out from the IdP.

Authentication method Select an authentication method.

3. Click **Save**.
4. The details for following settings are available when configuring the service provider device on FortiSandbox (*System > SSO > enable SSO*).

From FortiSandbox	To FortiAuthenticator field
SP Entity ID (https://10.1.0.1/sso_sp)	SP entity ID
SP login URL (https://10.1.0.1/sso_sp/op/?acs)	SP ACS (login) URL
SP logout URL (https://10.1.0.1/sso_sp/op/?sls)	SP SLS (logout) URL



SP entity ID, SP ACS (login) URL, and SP SLS (logout) URL must match the respective FortiSandbox configurations as the service provider device side.



If you are deploying FortiSandbox or FortiAuthenticator on a public cloud you will need to update the Public IP to Private IP manually. Otherwise, the URLs will not work.

5. Click **OK**.
6. Select and click **Edit** to edit the recently created SP.

7. In *Assertion Attribute Configuration*:
 - From the *Subject NameID* dropdown, select *Username* .
 - From the *Format* dropdown, select *urn:oasis:names:tc:SAML:2.0:nameid-format:unspecified* .

8. Under *Assertion Attributes*, click *Add Assertion Attribute*:
 - a. In the *SAML attribute* field, enter username.
 - b. From the *User* attribute dropdown, select *Username*.
9. Click *Add Assertion Attribute* again and create a new SAML attribute.
 - a. For *User attribute* select *Group*.
 - b. In the *SAML attribute* field enter groupname.
10. Click *OK* to save changes.

Configure SAML SSO settings on FortiSandbox

To configure FortiSandbox as a service provider:

1. On FortiSandbox go to *System > Certificates* and import the IdP certificate exported from FortiAuthenticator.
2. On FortiSandbox go to *System > SAML SSO* and configure the settings. Copy the following URLs from FortiAuthenticator SAML Service Provider page:

From Authenticator	To FortiSandbox field
IdP entity id (http://x.x.x.x/saml-idp/dnax3e5175oisk76/metadata/)	IdP Entity ID
IdP single sign-on URL (https://x.x.x.x/saml-idp/dnax3e5175oisk76/login/)	IdP login URL
IdP single logout URL (https://x.x.x.x/saml-idp/dnax3e5175oisk76/logout/)	IdP logout URL

3. For *IdP certificate*, choose the certificate you imported earlier.
4. Click *OK*.



When FortiSandbox and FortiAuthenticator are accessed by assigned external public IPs, the IdP and SP URLs should be updated with public IPs.

Connecting from the client with a FortiAuthenticator user

To connect from the client with FortiAuthenticator users:

1. On the client, open a browser (such as Firefox) and enter the FortiSandbox IP. On the FortiSandbox login page, click *Login with Single Sign-On*.

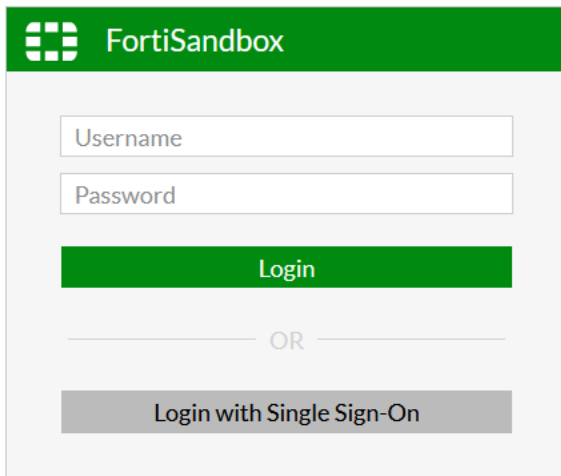

2. You are redirected to the FortiAuthenticator login page.

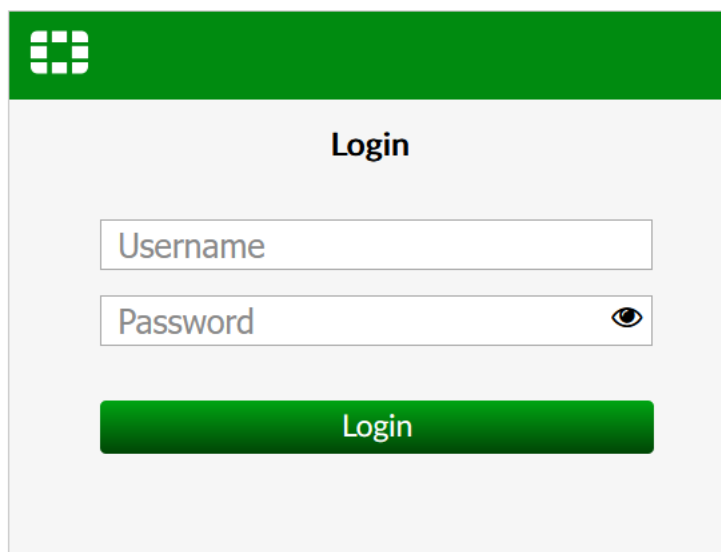

3. Enter the credentials of FortiAuthenticator user to log into FortiSandbox as a FortiSandbox SSO administrator



The first time the user logs in, FortiSandbox will automatically create an SSO administrator with default built-in *read-only* admin profile. The administrators with *read-write* access are allowed to update SSO administrators. For more information about profiles, see [Admin Profiles on page 156](#).

SAML SSO in HA cluster

To keep the non-primary SSO settings with the matched certificate, import all HA non-primary nodes' SSO IdP certificates into the HA primary node before the real-time synchronization or HA failover.

Primary and secondary nodes with different SSO methods

SAML SSO in HA cluster is only supported locally. When the HA primary and secondary nodes have different SSO methods:

- Before you enable HA primary, synchronize the real-time settings for Administrators, Admin Profiles, User Password Policy, Device Groups, Netshare Groups, LDAP/RADIUS Servers and Certificates
- Ensure all SSO certificates on all HA nodes are imported on the HA primary node. This is because the SSO settings on secondary nodes are not overridden by the primary node. Only the certificates will be replaced.
- When HA failover is triggered, the SSO setting will not be synchronized. However, the certificates will be overridden.

RADIUS Servers

The FortiSandbox system supports remote authentication of administrators using RADIUS servers. To use this feature, you must configure the appropriate server entries in the FortiSandbox unit for each authentication server in your network.

If you have configured RADIUS support and require a user to authenticate using a RADIUS server, the FortiSandbox unit contacts the RADIUS server for authentication. To authenticate with the FortiSandbox unit, the user enters a user name and password. The FortiSandbox unit sends this user name and password to the RADIUS server. If the RADIUS server can authenticate the user, the FortiSandbox unit successfully authenticates the user. If the RADIUS server cannot authenticate the user, the FortiSandbox unit refuses the connection.

The following options are available:

Create New	Select to add a RADIUS server.
Edit	Select a RADIUS server in the list and click <i>Edit</i> in the toolbar to edit the entry.
Delete	Select a RADIUS server in the list and click <i>Delete</i> in the toolbar to delete the entry.

The following information is displayed:

Name	The RADIUS server name.
Primary Address	The primary server IP address.
Secondary Address	The secondary server IP address.
Port	The port used for RADIUS traffic. The default port is 1812.
Auth Type	The authentication type the RADIUS server requires. The default setting of ANY has the FortiSandbox try all the authentication types. Select <i>ANY</i> , <i>PAP</i> , <i>CHAP</i> , or <i>MSv2</i> .

To create a new RADIUS server:

1. Go to *System > RADIUS Servers*.
2. Select *Create New* from the toolbar.
3. Configure the following settings:

Name	Enter a name to identify the RADIUS server. The name should be unique to FortiSandbox.
Primary Server Name/IP	Enter the IP address or fully qualified domain name of the primary RADIUS server.
Secondary Server Name/IP	Enter the IP address or fully qualified domain name of the secondary RADIUS server.
Port	Enter the port for RADIUS traffic. The default port is 1812.
Auth Type	Enter the authentication type the RADIUS server requires. The default setting of ANY has the FortiSandbox try all the authentication types. Select one of: <i>ANY</i> , <i>PAP</i> , <i>CHAP</i> , or <i>MSv2</i> .
Primary Secret	Enter the primary RADIUS server secret.
Secondary Secret	Enter the secondary RADIUS server secret.
NAS IP	Enter the NAS IP address.

4. Select *OK* to create the RADIUS server.



FortiSandbox supports the shared RADIUS secret of PAP authentication type up to a maximum of 52 characters in length.

Mail Servers

The Mail Server page allows you to adjust the mail server settings. Go to *System > Mail Server* to view the *Mail Server Settings* page. Use this page to configure notifications for malware detected as well as the weekly report global email list.

The following options are available:

SMTP Server Address	Enter the SMTP server address.
Port	Enter the SMTP server port number. If you use port 587, the SMTP process uses STARTTLS to encrypt the credentials and the email.
E-Mail Account	Enter the mail server email account. This is the <i>From</i> address.

Login Account	Enter the mail server login account.
Password	Enter the password.
Confirm Password	Confirm the password.
Send a notification email to the global email list when Files/URLs with selected rating are detected	Select to enable this feature. When enabled, a notification email is sent to the global email list, individual device, and VDOM/Domain email address when malware is detected.
Global notification mail receivers list (separated by comma)	Enter the email addresses that comprise the global email list.
What rating of job to send alert email	Select the rating of jobs that are included in the email alerts. Options include: <i>Malicious, High Risk, Medium Risk, and Low Risk</i> .
Notification mail subject template	Enter the subject line for the notification emails.
Send a notification email to the Device/Domain/VDOM email list when Files/URLs with selected ratings are detected	When a malware from an input device is detected, send a notification email to its admin email address.
What rating of job to send alert email	Select the rating of jobs that will trigger email notification. Options include: <i>Malicious, High Risk, Medium Risk, and Low Risk</i> .
Notification mail subject template	Enter the subject line for the notification emails.
Send a notification email to the email list when malicious/suspicious verdict is returned to client device	When enabled, a notification email is sent to an email list when a malicious/suspicious rating is retrieved by a client device.
Use FQDN as unit address for job detail link (default is IP address of Port1)	Use FQDN instead of port1 IP for a job detail link inside alert emails and reports.
FQDN Name	Enter FQDN name.
Send scheduled system resource status report to the email list	When a VM is near the custom threshold, send a usage status email to the admin email address.
System status email receivers list (separated by comma)	Enter the email addresses to get the status email.
Send alert email when:	<p>CPU Usage >: Customize threshold of CPU usage.</p> <p>RAM Usage >: Customize threshold of RAM usage.</p> <p>Disk Usage >: Customize threshold of Disk usage.</p> <p>Ramdisk Usage: Customize threshold of VM usage.</p> <p>Total Pending Jobs: Customize threshold of total pending jobs.</p> <p>Average Scan Time: Customize threshold of average scan time.</p>

	System check every (minutes): Customize system check schedule. A system status alert email will be sent when any threshold is reached.
Send scheduled PDF report to global email receiver	Select to send a report email to the global email list.
Global email list to receive scheduled summary/detail report (separated by comma)	Enter the email addresses that comprise the global email list.
Send scheduled PDF report to Device/Domain/VDOM email address	Select to send PDF report to device/Protected Domain/VDOM email address also. The report will only contain jobs sent from the device/FortiMail Protected Domain/VDOM.
Report Schedule Type:	Select the report schedule type: <i>Hourly, Daily, or Weekly</i> . For different schedule types, different frequency options are displayed. If the schedule type is <i>Daily</i> , the user can set the hour for which the report is generated.
Week Day:	Select the day the report is to be sent.
At hour:	Select the hour interval the report is to be sent.
Include job data before Days (0-28) days:	Select the job data before 0-28 days.
Hours (0-23):	Select the job data before 0-23 hours. For example, if the user wants to include job data from the last two days and three hours before report generation, the user should select two in the Day Field and three in the Hour field.
What rating of job to be included in the detail report	Select the rating of jobs that are included in the reports. Options include: <i>Malicious, High Risk, Medium Risk, and Low Risk</i> .
OK	Click <i>OK</i> to apply any changes made to the mail server configuration.
Send Test Email	Click <i>Send Test</i> to send a test email to the global email list. If an error occurs, the error message will appear and is recorded in the <i>System Logs</i> .
Restore Default	Click <i>Restore Default</i> to restore the default mail server settings.

FortiGuard

Advanced AI

The Advanced AI feature plays a crucial role in the Static Scan stage, employing cutting-edge AI models developed through FortiGuard's Machine Learning technology to identify unknown malware. Every file processed undergoes thorough scanning by this sophisticated engine. When malware is detected, an indicator labeled *Detected by PAIX* is generated, with PAIX serving as the internal code name for the detection engine.

In addition to this immediate detection, the system provides detailed insights into the detection process. Key attributes related to the matching indicators are included in the job detail report, offering users valuable information about the nature of the threat and enhancing their understanding of potential vulnerabilities. This comprehensive approach ensures that users not only receive timely alerts but also gain deeper visibility into the security landscape.

The AI engine and initial AI model are available upon upgrade to firmware version 5.0.0. Subsequent updates on the AI model are available as part of the Advanced Subscription.

Go to *System > FortiGuard* to view the FortiGuard page.

The following options and information are available:

Module Name	FortiGuard module names such as <i>Antivirus Scanner</i> , <i>Antivirus Extreme Signature</i> , <i>Antivirus Active Signature</i> , <i>Antivirus Extended Signature</i> , <i>Network Alerts Signature</i> , <i>Sandbox System Tools</i> , <i>Sandbox Rating Engine</i> , <i>Sandbox Tracer Engine</i> , <i>AI Engine and Model</i> , <i>Industry Security Signature</i> , and <i>Traffic Sniffer</i> . All modules automatically install update packages when they are available on FDN.
Current Version	Current version of the module. For <i>AI Engine and Model</i> , the default version is the one integrated with the Rating Engine.
Last Check Time	Date and time that module last checked for an update.
Last Update Time	Date and time that module was last updated.
Status	Status of the last update attempt.
Upload Package File	Click <i>Upload File</i> to select a package file on the management computer, then click <i>OK</i> to upload the package file to FortiSandbox. If the unit has no access to Fortinet FDN servers, go to the Customer Service and Support site to download package files manually.
Update from FDN now	Click <i>Update from FDN now</i> to connect to the FDN server/proxy and get updates.

FortiGuard Server Location	Select FDN servers for package update and Web Filtering query. The default selection is <i>Nearest</i> , which is the FDN server nearest to the unit's time zone. Selecting the <i>US Region</i> means using only servers in the USA. Selecting <i>Global</i> means using global FDN servers via secure connection via HTTPS port 443 to do FDN update.
FortiGuard Server Settings	
Use overriding FDN server to download module updates	Enable this option to use an overriding FDN server or FortiManager to download module updates. Enter the overriding server IP address or FQDN in the text box. Enabling this option disables <i>FortiGuard Server Location</i> . Click <i>Connect FDN Now</i> to schedule an immediate update check.
Use Proxy	Enable this option to use a proxy. Configure the <i>Proxy Type (HTTP Connect or SOCKS v5)</i> , <i>Server Name/IP, Port, Proxy Username</i> , and <i>Proxy Password</i> .
FortiGuard Web Filter Settings	
Secure Connection	FortiSandbox supports secure XOR encrypted connection for FortiGuard web filter settings. When enabled, the system uses secure XOR encrypted mode for the connection.
Use overriding server for web filtering query	Enable this option to use an overriding server address for web filtering query using the server IP address or FQDN in the text box. The default is the web filtering server nearest the unit's time zone.
Use Proxy	Enable this option to use a proxy. Configure the <i>Socks5 or HTTP connect Server Name/IP, Port, Proxy Username</i> , and <i>Proxy Password</i> . <i>HTTP Connect</i> option only appears when user selects <i>Secure Connection</i> .
VM Image Download Proxy Settings	
Use Proxy	Enable this option to use a proxy. Configure the <i>Proxy Type (HTTP Connect or SOCKS v5)</i> , <i>Server Name/IP, Port, Proxy Username</i> , and <i>Proxy Password</i> .
FortiSandbox Community Cloud & Threat Intelligence Settings	
Secure Connection	Enable this option to use HTTPS to perform a file query to Community Cloud. When this option is selected, FortiSandbox will use a built-in file query server supporting HTTPS. <i>Use overriding server for community cloud server query</i> will be hidden.
Use overriding server for community cloud server query	Enable this option when using FortiManager for the Community Cloud server query in your environment or select a different port. When using FortiManager for Community Cloud server query, only verdict information is available for malware. The malware's behavior information is not available.
Use Proxy	Enable this option to use a proxy. Configure the <i>Socks5 Server Name/IP, Port, Proxy Username</i> , and <i>Proxy Password</i> . When <i>Secure Connection</i> enabled it supports both Socks v5 and HTTP, otherwise only Socks v5.
FortiSandbox WindowsCloud VM Settings	
Server Regions	This option requires a Windows Cloud VM contract.

	Select the region where Windows Cloud VMs are used to scan files.
Use overriding APT server (IP or FQDN)	You can override the APT server and manually enter the IP address of the APT server which hosts the Windows Cloud VM.
Use Proxy	Enable this option to use a proxy. Configure the <i>Proxy Type (HTTP Connect or SOCKS v5)</i> , <i>Server Name/IP, Port, Proxy Username</i> , and <i>Proxy Password</i> .
FortiSandbox Real-time Zero-Day Anti-Phishing Service Settings	
Server Regions	This option requires a Real-time Zero-Day Anti-Phishing contract. Select the region where Real-time Zero-Day Anti-Phishing is used to scan URLs.
Use overriding Real-time Zero-Day Anti-Phishing Service server	Enable this option to use an overriding server address for Real-time Zero-Day Anti-Phishing Service query using the server IP address and Port in the text box. The default port refers to Port and access control information .
Use Proxy	Enable this option to use a proxy. Configure the <i>Proxy Type (HTTP Connect or SOCKS v5)</i> , <i>Server Name/IP, Port, Proxy Username</i> , and <i>Proxy Password</i> .



- A valid PAIX subscription is required to manually upload the PAIX package.

Real Time Anti-Phishing

Real-Time Anti-Phishing (RTAP) is a FortiGuard service offering which detects, in real-time, signs of Phishing, SPAM or Malicious content in a website. The RTAP service is subscription based and available exclusively on FortiSandbox.

How RTAP works:

FortiSandbox receives submissions of website URLs embedded in both emails and files from any supported security fabric or third-party device. FortiSandbox can extract the embedded URLs from documents and QR codes. URLs go through a series of checks beginning with a categorization check from the Web Content Filtering service. If URL Sandboxing Pre-Filter is enabled and the URL is unrated or in one of the general or dynamic web categories such as *Information Technology*, *Dynamic DNS*, *New Domain*, *Personal Sites*, *Web Hosting* and *URL shortening*, then it is submitted to the RTAP service. If URL Sandboxing Pre-Filter is disabled then all URLs are submitted to the RTAP service. For more information, see [Web Category on page 133](#)

For the URL to be submitted to the RTAP service, the Scan Profiles must have the WebLink file type associated with a VM image. The URL is submitted to the Sandboxing VM for Dynamic analysis to collect web download behavior. Submissions to the RTAP service are therefore limited to the capacity of VM clones.

Upon receiving a URL, the RTAP service browses the website utilizing several patented and patent-pending techniques to detect any signs of Phishing, SPAM or Malicious characteristics. Each URL submission to the services generally takes between 30 to 60 seconds before a result is sent back to the FortiSandbox.

Sandbox Community Cloud

The *Sandbox Community Cloud* is included in the Sandbox Threat Intelligence subscription service. When enabled, the Community Cloud provides an avenue for customers to share threat intelligence with FortiSandbox worldwide and FortiGuard. FortiGuard acts as the host for the information sharing, while each subscriber (who enables Submissions) contributes. All FortiSandbox are able to access the cloud query to check if the SCC has seen a specific threat.

You can use the community cloud to:

- Query a file to check if an existing verdict is available. See, [File Scan Flow on page 115](#).
- Skip Dynamic scan on existing files (when a similar file exists in the Cloud) and only forward new files to Dynamic scan. See, [Cloud storage on page 84](#) and [Network Share on page 55](#).



Community Cloud Query is enabled by default. To disable go to *Scan Policy and Object > Scan Profile > Advanced Tab*.

Certificates

In this page you can import, view, download and delete certificates. Certificates are used for secure connections to an LDAP server, system HTTPS, SSH services, ICAP server and MTA adapter. FortiSandbox has one default certificate *firmware* which is installed on the unit by Fortinet.



FortiSandbox does not generate certificates, but does support importing certificates for SSH and HTTPS access to FortiSandbox. The following formats are supported: .crt and .pem .

The following options are available:

Import	Import a certificate.
Service	Select to configure specific certificates for the HTTP and SSH servers.
View	Select a certificate in the list and select <i>View</i> in the toolbar to view the CA certificate details.
Delete	Select a certificate in the list and select <i>Delete</i> in the toolbar to delete the certificate.

The following information is displayed:

Name	The name of the certificate.
Subject	The subject of the certificate.

Status	The certificate status, active or expired.
Service	HTTPS or SSH service that is using this certificate.
Certificate	Download the server certificate.
Sub Certificate	Download the intermediate CA (Certificate Authority) certificate if you are using a certificate chain.
Cacert	Download the CA (Certificate Authority) certificate.

To import a certificate:

1. Go to *System > Certificates*.
2. Click *Import* from the toolbar.
3. Enter the certificate name in the text field.
4. Click *Upload Certificate* and *Upload Key* from your management computer.
5. Optionally, you can import the intermediate CA certificate by clicking the *Upload Sub Certificate*.
6. Click *OK* to import the certificate.



You also have the option to import a Password Protected PKCS12 Certificate. To import a PKCS12 Certificate, check the PKCS12 Format box upon importing a new certificate and enter the password. When checking the PKCS12 Format box, the other *upload* buttons will be hidden and are replaced by the *Upload PKCS12 File* button.

To view a certificate:

1. Go to *System > Certificates*.
2. Select the certificate from the list and click *View* from the toolbar.
3. The following information is available:

Certificate Name	The name of the certificate.
Status	The certificate status.
Serial number	The certificate serial number.
Issuer	The issuer of the certificate.
Subject	The subject of the certificate.
Effective date	The date and time that the certificate became effective.
Expiration date	The date and time that the certificate expires.

4. Click *Back* to return to the *Certificates* page.

To download a CA certificate:

1. Go to *System > Certificates*.
2. Click the download icon  in one of the columns: *Certificate*, *Sub Certificate*, or *Cacert*.

To delete a CA certificate:

1. Go to *System > Certificates*.
2. Select the certificate from the list and click *Delete* from the toolbar.
3. Click *OK* in the *Are You Sure* confirmation page.



Firmware certificate(s) cannot be deleted.

Netshare keys

In this page you can import, view and delete Netshare Keys for Google Cloud Storage network share and quarantine

To import a Google Cloud storage key:

1. Go to *System > Networkshare Keys*.
2. Click *Import*, to import the private key.

Import Networkshare Key

Mount Type:

 Upload Networkshare Key File

Maximum 64 KBs

Access key name:

May contain letters, numbers and -_ characters only, maximum 64 characters.

Description:

Login Disclaimer

Go to *System > Login Disclaimer* to customize the warning message, and to enable or disable the Login Disclaimer.

If enabled, the Login Disclaimer will appear when a user tries to log into the unit from the GUI or SSH session.



After the message is edited, the SSH daemon needs to restart to display the new message. Users who are logged into FortiSandbox with the SSH client will lose their connection while an admin is editing the Login Disclaimer.

SNMP

In version 3.0.6 and later, all admin ports that are specified support SNMP.

SNMP is a method for a FortiSandbox system to monitor your FortiSandbox system on your local computer. You will need an SNMP agent on your computer to read the SNMP information.

Using SNMP, your FortiSandbox system monitors for system events including CPU usage, memory usage, log disk space, interface changes, and malware detection. Go to *System > SNMP* to configure your FortiSandbox system's SNMP settings.

SNMP has two parts - the SNMP agent or the device that is sending traps, and the SNMP manager that monitors those traps. The SNMP communities on the monitored FortiSandbox are hard coded and configured in the SNMP menu.

The FortiSandbox SNMP implementation is read-only — SNMP v1, v2c, v3 compliant SNMP manager applications, such as those on your local computer, have read-only access to FortiSandbox system information and can receive FortiSandbox system traps.

From here you can also download FortiSandbox and Fortinet core MIB files.

Configuring the SNMP agent

The SNMP agent sends SNMP traps that originate on the FortiSandbox system to an external monitoring SNMP manager defined in one of the FortiSandbox SNMP communities. Typically an SNMP manager is an application on a local computer that can read the SNMP traps and generate reports or graphs from them.

The SNMP manager can monitor the FortiSandbox system to determine if it is operating properly, or if there are any critical events occurring. The description, location, and contact information for this FortiSandbox system will be part of the information an SNMP manager will have. This information is useful if the SNMP manager is monitoring many devices, and it will enable faster responses when the FortiSandbox system requires attention.

To configure the SNMP agent:

1. Go to *System > SNMP* to configure the SNMP agent.
2. Configure the following settings:

SNMP Agent	Select to enable the FortiSandbox SNMP agent. When this is enabled, it sends FortiSandbox SNMP traps.
Description	Enter a description of this FortiSandbox system to help uniquely identify this unit.
Location	Enter the location of this FortiSandbox system to help find it in the event it requires attention.
Contact	Enter the contact information for the person in charge of this FortiSandbox system.

SNMP v1/v2c	Create new, edit, or delete SNMP v1 and v2c communities. You can select to enable or disable communities in the edit page. The following columns are displayed: Community Name, Queries, Traps, Enable.
SNMP v3	Create new, edit, or delete SNMP v3 entries. You can select to enable or disable queries in the edit page. The following columns are displayed: User Name, Security Level, Notification Host, Queries.

To create a new SNMP v1/v2c community:

1. Go to *System > SNMP*.
2. In the SNMP v1/v2c section of the screen select *Create New* from the toolbar.
3. Configure the following settings:

Enable	Select to enable the SNMP community.
Community Name	Enter a name to identify the SNMP community.
Hosts	The list of hosts that can use the settings in this SNMP community to monitor the FortiSandbox system.
IP/Netmask	Enter the IP address and netmask of the SNMP hosts. Select the <i>Add</i> button to add additional hosts.
Queries v1	Enter the port number and select to enable. Enable queries for each SNMP version that the FortiSandbox system uses.
Queries v2c	Enter the port number and select to enable. Enable queries for each SNMP version that the FortiSandbox system uses.
Traps v1	Enter the local port number, remote port number, and select to enable. Enable traps for each SNMP version that the FortiSandbox system uses.
Traps v2c	Enter the local port number, remote port number, and select to enable. Enable traps for each SNMP version that the FortiSandbox system uses.
SNMP Events	<p>Enable the events that will cause the FortiSandbox unit to send SNMP traps to the community.</p> <ul style="list-style-type: none"> • CPU usage is high This event is triggered when CPU usage is higher than 90%. The trap is sent every minute. • Memory is low This event is triggered when memory usage is higher than 90%. The trap is sent every minute. • Hard disk usage is high This event is triggered when hard disk usage is higher than 80%. The trap is sent every minute. • RAID disk information The trap message is delivered every hour. • Average scan time The average scan time is the last hour. The trap is sent every hour.

- Topology map and health check status for cluster has changed
- Interface is up or down
- Power Supply failure (not available on FSA-500F model)
- Malware is detected
- License or contract is close to expiry
This event is triggered 1, 2, 3, 7, 15, and 30 days at 00:00:05 hours before a FortiSandbox license or contract is to expire. For example, an event is triggered:
 - 30 days at 00:00:05 hours before a VM license is to expire.
 - 15 days at 00:00:05 hours before a custom VM contract is to expire.

4. Click *OK* to create the SNMP community.

To create a new SNMP v3 user:

1. Go to *System > SNMP*.
2. In the SNMP v3 section of the screen, select *Create New* from the toolbar.
3. Configure the following settings:

Username	Enter the name of the SNMPv3 user.
Security Level	Select the security level of the user. Select one of the following: <ul style="list-style-type: none"> • None • Authentication only • Encryption and authentication
Authentication	Authentication is required when <i>Security Level</i> is either <i>Authentication only</i> or <i>Encryption and authentication</i> .
Method	Select the authentication method. Select either: <ul style="list-style-type: none"> • MD5 (Message Digest 5 algorithm) • SHA1 (Secure Hash algorithm)
Password	Enter the authentication password. The password must be a minimum of 8 characters.
Encryption	Encryption is required when <i>Security Level</i> is <i>Encryption and authentication</i> .
Method	Select the encryption method, either DES or AES.
Key	Enter the encryption key. The encryption key value must be a minimum of 8 characters.
Notification Hosts (Traps)	
IP/Netmask	Enter the IP address and netmask. Click the <i>Add</i> button to add additional hosts.
Query	
Port	Enter the port number. Select to <i>Enable</i> the query port.

SNMP v3 Events

Select the SNMP events that will be associated with that user.

- CPU usage is high
This event is triggered when CPU usage is higher than 90%. The trap is sent every minute.
- Memory is low
This event is triggered when memory usage is higher than 90%. The trap is sent every minute.
- Hard disk usage is high
This event is triggered when hard disk usage is higher than 80%. The trap is sent every minute.
- RAID disk information
The trap message is delivered every hour.
- Average scan time
The average scan time is the last hour. The trap is sent every hour.
- Topology map and health check status for cluster has changed
- Interface is up or down
- Power Supply failure (not available on FSA-500F model)
- Malware is detected
- License or contract is close to expiry
This event is triggered 1, 2, 3, 7, 15, and 30 days at 00:00:05 hours before a FortiSandbox license or contract is to expire. For example, an event is triggered:
 - 30 days at 00:00:05 hours before a VM license is to expire.
 - 15 days at 00:00:05 hours before a custom VM contract is to expire.

4. Click *OK* to create the SNMP community.

MIB files

To download MIB files, scroll to the bottom of the SNMP page, and select the MIB file that you would like to download to your management computer.

FortiSandbox SNMP MIB

- [Download FortiSandbox MIB File](#)
- [Download Fortinet Core MIB File](#)





System Recovery

Go to the *System > System Recovery* page to backup and restore FortiSandbox configurations. You have the option of backing up a configuration to a local PC or within FortiSandbox to restore at a later date. You can also

schedule backups to a remote server which is a suggested practice. When upgrading, FortiSandbox automatically backs up the configuration. All backup configurations are displayed on this page.

Local Backup

The table displays the following information for the local FortiSandbox (information for the Local PC is not displayed):

Build Number	The build number associated with the configuration.	
Date	The date the configuration was backed up.	
User Name	The administrator who backed up the configuration. The username is blank when FortiSandbox creates a backup configuration during upgrade.	
Comments	Any details entered by the administrator when the configuration was backed up <i>Backup config before upgrade firmware</i> is displayed when FortiSandbox creates a backup configuration during upgrade.	
Actions		Show summary information.
		Delete the backup configuration. You can delete multiple configurations at the same time.
		Restore system configuration with this backup.
		Download the backup.

To backup a configuration:

1. Go to *System > System Recovery*.
2. (Optional) Select *Use hostname as backup file name*.
3. Click one of the following buttons:

Local PC	The <i>Confirm</i> pane slides open. Click <i>Yes</i> , to save configuration to your device.
Local FSA	The <i>Backup to Local FSA</i> pane slides open. <ol style="list-style-type: none"> a. (Optional) Enter the configuration details on the <i>Comment</i> field. b. Click <i>OK</i>. The configuration is added to the table.

Remote Backup

Use *Remote Backup* to schedule automatic backups on the server.

To schedule a remote backup:

1. Go to *System > System Recovery*.
2. Under *Remote Backup* configure the following settings.

Server Type	The protocol to transfer the backup file. Only <i>SCP</i> is available at this time.
Server Address	The IP address of the server. This also supports format <IP address:port number>. The default port number is 22. You can also use the self-defined port number.
File Path	The backup file path.
Username	The username to log in to the server.
password	The password to log into the server
Backup Schedule	The schedule to generate the backup file (hourly, daily, weekly , monthly and yearly).

3. (Optional) Select *Use hostname as backup file name*.
4. Click *Set Remote Backup*.
5. (Optional) Click *Reset Config* to update the settings.



In HA cluster, the remote backup setting will be synced except for the schedule

Restore

To restore a configuration:

1. Go to *System > System Recovery*.
2. Click *Restore File* and open the configuration file.
3. (Optional) Select *Restore Administrators, Admin Profiles, Certificates, LDAP Servers and Radius Servers*.



Select this option when all the configurations must be restored, otherwise the Administrators, Admin Profiles, Certificates, LDAP Servers and Radius Servers will not be restored.

4. Click *Restore*. The *Confirm* pane slides open. Click *Yes* to reset the settings.

Event Calendar

This page displays major events. You can show your events in a day, week, month, or timeline format. You can drill down to *day* level and click each event for its details.

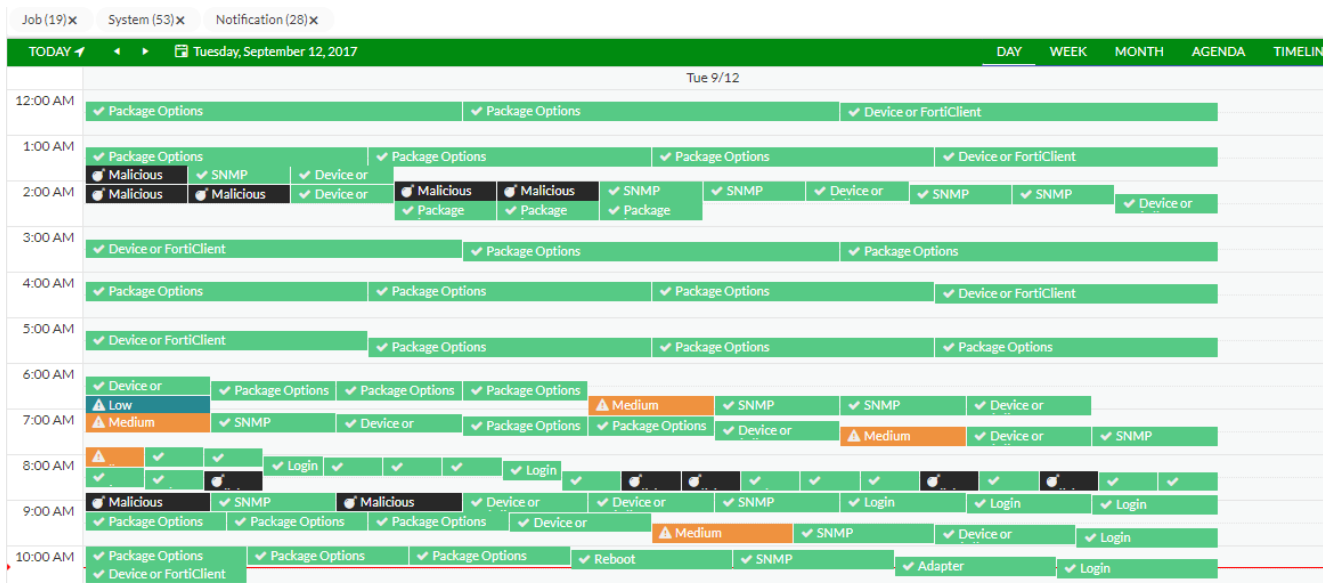

The following options are available:

Filter	You can filter for the events you would like to see by turning on/off the event.
Day	Click to display the event calendar by day.
Week	Click to display the event calendar by week.
Month	Click to display the event calendar by month.
Agenda	Click the Agenda tab to schedule jobs.
Timeline	Click to display the event calendar by timeline.

The following events are displayed:

System Events	<ul style="list-style-type: none"> • System login/logout • Reboot/shutdown • Firmware upgrade • System critical errors • System configuration changes (includes user creation, scan profile change etc.)
Notification Events	<ul style="list-style-type: none"> • PDF report generation • Network share scan
Threat Events	<ul style="list-style-type: none"> • Malware/URL detection. Double-clicking on the event will show its detailed information in a new browser tab.

You can configure what types of events to show in the *System > Event Calendar Settings* page.

Event Calendar Settings

System > Event Calendar Settings allow you to specify which types of events display in *System > Event Calendar*. The default displays all available event types.

Event types include: *Send Mail, Backup, Restore, Network Share, Network, DNS, Routing, Admin, Mail Server, Time Change, Hostname Change, LDAP, Certificate, VM, RADIUS, Login, Logout, System, Reboot, Job Alert, Shutdown, Backup, Restore, Firmware Upgrade, Incident Assist, Scan Profile, Scan Policy and Object, Allow/Block List or White/Black List, and Job Details.*

Moving an event into the *Unapplied Event Types* category will hide all instances of those events in the *Event Calendar*. Moving an event into the *Applied Event Types* category will restore these events to the calendar, including past events.

Events can be moved between the two categories by dragging and dropping them.

Job View Settings

Go to *System > Job View Settings* to define columns and their order for each job result.

Job Result pages show job data, including:

- *Scan Job > File Job*
- *Scan Job > URL Job*
- Job links in *Dashboard > Status > Scan Statistics* widget

The selected columns and their order are shown in the top row, while the available columns are listed in the bottom row. You can drag and drop columns to adjust their order.

Additionally, the *Customize* icon on the job result pages allows you to open the *Job View Settings* page and dynamically adjust the settings

The *File Detection Columns* section defines the columns and their order for displaying file scan results. Similarly, the *URL Detection Columns* section controls the columns and the order to display URL scan results.

The following columns are available to choose from for the View Job pages:

Action	View job details or rescan <i>Suspicious</i> or <i>Malicious</i> files.
Destination	The IP address of the client that downloaded the file.
Detection	The date and time that the file was detected by FortiSandbox.
Device	The job's input source.
Email Sender	The email address of the sender.
Email Receiver	The recipient's email address.

Email Subject	The email subject line.
Filename	The name of the file.
Infected OS	The OS version of the FortiSandbox VM that was used to make the Suspicious verdict.
Job ID	The ID of the scan job.
Malware	The name of the virus in a Malicious file.
MD5/SHA1/SHA256	The checksum values of the scanned file.
Rated By	The method by which the job was rated, such as the VM Engine.
Rating	The rating of the scan job. It can be one of one of the following: <i>Malicious</i> , <i>High Risk</i> , <i>Medium Risk</i> , <i>Low Risk</i> , <i>Clean</i> or <i>Unknown</i> .
Scan Unit	The serial number of the FortiSandbox unit that scanned the file.
Service	The traffic protocol used for transferring the file, such as FTP, HTTP, IMAP, POP3, SMB, SMTP or OTHER
Source	The IP address of the host where the file was downloaded from.
Submitted Filename	The scan job's filename, or a file's parent archive filename, or the submitted filename associated with an On-Demand scan.
Submit User	The username or IP address of the user who submitted the file or URL for scanning.
Suspicious Type	The type of malware, such as <i>Attacker</i> , <i>Riskware</i> or <i>Trojan</i> .
URL	The scanned URL. Available only on URL scan job pages.

Settings

Go to *System > Settings* to configure the administrator account settings.

GUI	
Idle timeout	Length of time before FortiSandbox logs out an inactive user, from 1 to 480 minutes.
Language	Change the GUI language.
Theme	Select the visual appearance for the GUI. Options include: <i>Classic</i> , and <i>Dark Matter</i> . The default theme is <i>Classic</i> .
Job Settings	
Show debugging process in job details page	Enable this option to show detailed debugging information in <i>Job Detail</i> , otherwise only show relative important information . This is disabled by default.

Alert Notification**Show alarms of unprocessed detections**

Enable this option to display notifications as a bell icon in the top-right corner of the GUI. You can specify the time period and rating criteria to monitor files rated as suspicious or malware on the *Incident Assist* page.

VM External Network Access**Allow Virtual Machines and URL content check to access external network via Port3**

Enable to allow Virtual Machines and URL content check to access external network via Port3. For further details, refer to the port3 (VM outgoing interface) topic in [Interfaces](#).

Status	Port3 status to access the Internet.
Gateway	Enter the next hop gateway IP address. The <i>System</i> and VM cannot use the same gateway to access the Internet.
If Port3 is inaccessible, Disable SIMNET	Disables SIMNET when Virtual Machines are not able to access external network through the outgoing port3.
DNS	DNS server used by the VM when scanning a file or URL. If a proxy server is configured, you can specify an external DNS server that can be accessed through the proxy via Port3. When this field is empty, the system-level DNS server will be used and accessed through the system routings.
Use Proxy	Enable this option to use the proxy. Configure the <i>Proxy Type, Server Name/IP, Port, Proxy Username, and Proxy Password</i> . When the proxy server is enabled, all outgoing TCP traffic from the Sandbox VM will be directed to the proxy server. For other traffic started by FortiSandbox firmware, such as FortiGuard Distribution Network (FDN) upgrades, the configurations should be done under the FortiGuard menu.
Proxy Type	Select the proxy type from the dropdown list. The following options are available: <ul style="list-style-type: none"> • HTTP Connect • SOCKS v5
Server Name/IP	Enter the proxy server name or IP address.
Port	Enter the proxy server port number.
Proxy Username	Enter a proxy username.
Proxy Password	Enter the proxy password.

Data Storage	
Delete original files of Clean or Other rating after	Enable to delete original files of jobs of <i>Clean</i> or <i>Other</i> ratings after a specified time. If the time is 0, the original files with either <i>Clean</i> or <i>Other</i> ratings will not be kept on the system. Original files with <i>Clean</i> or <i>Other</i> rating can be kept in the system for a maximum of 4 weeks.
Delete original files of Malicious or Suspicious rating after	Enable to delete original files with <i>Malicious</i> or <i>Suspicious</i> ratings after a specified time.
Delete all traces of jobs of Clean or Other rating after	Enable to delete all traces of jobs with <i>Clean</i> or <i>Other</i> ratings after a specified time. Traces of jobs with <i>Clean</i> or <i>Other</i> rating can be kept in system for a maximum of 4 weeks. The duration to keep the job traces should be longer than the duration to keep the original files.
Delete all traces of jobs of Malicious or Suspicious rating after	Enable to delete all traces of jobs with <i>Malicious</i> or <i>Suspicious</i> ratings after a specified time. This setting also affects the records in <i>Network Alerts</i> .
Automatically delete idle devices or FortiClients from the system if they haven't connected within	<p>Automatically delete idle devices, VDOMs, or FortiClient instances that have not connected within the configured time period.</p> <p>These devices, VDOMs, or FortiClient instances can be re-added as new, following the current authorization rules.</p> <p>Note: EMS is not deleted if it has active FortiClients connected to it.</p>
Maintain statistical records of jobs	<p>Enable to store job statistics in the <i>Scan Statistics</i> Dashboard widget for up to 4 weeks.</p> <p>This feature requires CPU and disk storage resources for hourly data aggregation. We recommend enabling this setting only when users specifically require historical scanned job counts and have a retention period (i.e., Cleanup schedule) shorter than the widget time period.</p>
Download of Original file package	
Set customized password for original files	Enter a password for the downloaded original file. When this option is disabled, the default password is <i>fortisandbox</i> .
Include a readme file containing extraction password in downloaded job package	All downloaded archive files will have a readme file with the customized password. When disabled, the readme file will be removed from the downloaded archive file.

Additional information

Saved files with a Clean, Unknown, Suspicious or Malware rating

By default, files with a:

- *Clean* or *Unknown* rating are saved for three days.
- *Suspicious* or *Malware* rating are saved for 28 days.

Log entries

Please be aware that the process of deleting job folders generates several log entries. These include:

- Clear xxxx job(s) from the database.
- Mark xxxx job(s) to be cleaned from storage.
- Clear xxxx job(s) from storage.

These logs provide a record of the actions taken during the job folder deletion process.

Network alert records

If *Delete all traces of jobs of Malicious or Suspicious rating after* is configured, the network alert records in *Log & Report > Network Alerts* will be deleted after the specified time. Otherwise, the network alert records deletion period is 32 days.

Network share records

Network Share records are saved for four weeks regardless of the *Data Storage* settings. For more information, [Network share record retention on page 59](#).

HA cluster

A single FortiSandbox device can scan a limited number of files in a given time period. To handle heavier loads, you can use multiple FortiSandbox devices in a load-balancing high availability (HA) cluster.

There are three types of nodes in a cluster: primary, secondary, and worker.

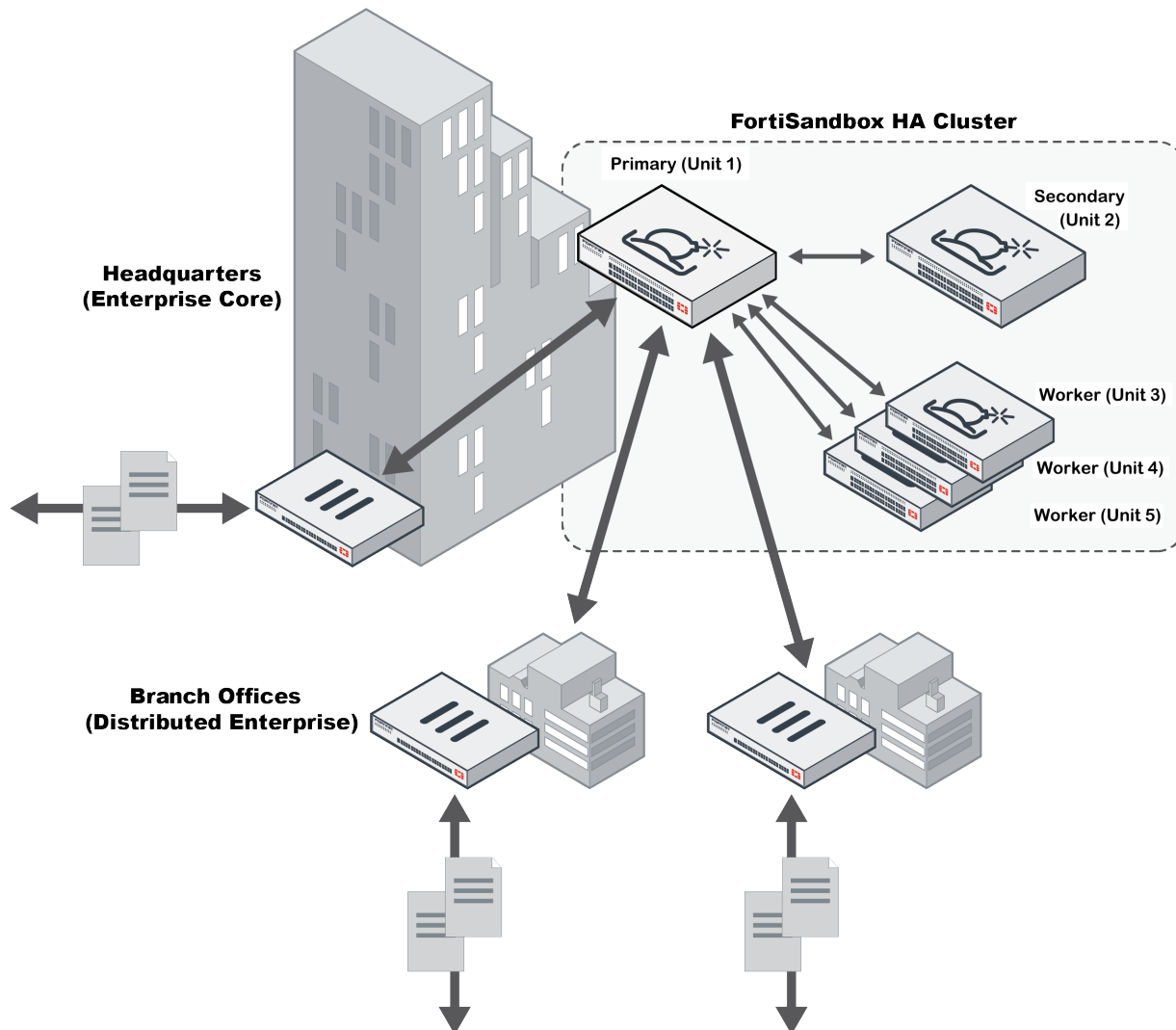

Primary

The primary node (Unit 1 in the diagram) manages the cluster, distributes jobs and gathers the results, and interacts with clients. It can also perform normal file scans. All scan-related configuration should be done on the primary node and they will be broadcasted from the primary node to the other nodes. Any scan-related configuration that has been set on a worker node will be overwritten.

On the primary node, users can:

- Change a worker node's role (secondary and worker)

- Configure a worker node's network settings
- Upgrade worker nodes
- View VM Jobs page of worker nodes
- Configure FortiGuard settings of worker nodes
- Configure VM images of worker nodes, such as setting clone numbers of each VM image
- Configure a ping server and/or echo server to frequently check unit's network condition and downgrade itself as a secondary node when necessary to trigger a failover

Although all FortiSandbox models can work as a primary node, we recommend using a more powerful model.

When the primary and secondary nodes are using a FortiSandbox VM model, you have the option of deploying without VM Clones. See, [Deploying primary and secondary nodes without VM Clones on page 218](#).

Secondary

The secondary node (Unit 2 in the diagram) is for HA support and normal file scans. It monitors the primary node's condition and, if the primary fails, the secondary will assume the role of primary. The former primary will then become a secondary when it is back up.

To support failover, ensure both the primary and secondary nodes are configured correctly:

- Both the primary and secondary nodes must be the same model.
- Both nodes must have the same network interface configuration, including:
 - The same subnet for port1.
 - The same subnet for port2.
 - The same subnet for port3.
 - The same routing table.

The secondary node is not required to set up a HA cluster but is recommended.

When the primary and secondary nodes are using a FortiSandbox VM model, you have the option of deploying without VM Clones. See, [Deploying primary and secondary nodes without VM Clones on page 218](#).

Worker

The worker nodes (Units 3–5 in the diagram) perform normal file scans and report results back to the primary and secondary nodes. They can also store detailed job information. Workers should have their own network settings and VM image settings.

Workers can be any FortiSandbox model including FortiSandbox VM. Workers in a cluster do not need to be the same model.

The total number of worker nodes, including the secondary node, cannot exceed 100.

For heavy job loads, use more powerful FortiSandbox models.

Cluster setup

To save time configuring an HA cluster, review the cluster prerequisites. After setting up the cluster, configure the cluster-level failover IP for each port except port3 and any ports monitored by the sniffer. Additionally,

enable Health Check to set up a ping server and/or echo server to ensure the network condition between client devices and FortiSandbox is always up.

FortiSandbox HA Cluster supports two operating modes:

- **Active-Active Mode (Default):**
Both the primary and secondary nodes perform the cluster scanning tasks, enabling load balancing.
- **Active-Passive Mode:**
Secondary nodes do not receive files from the primary node and do not perform the cluster scanning tasks. They operate in hot standby mode.

By default, the FortiSandbox HA Cluster operates in Active-Active Mode, unless configured otherwise. For more details and instructions on switching HA modes, see [Switching the HA mode on page 215](#).

This section contains the following topics:

- [HA cluster pre-requisites on page 212](#)
- [Example configuration on page 213](#)
- [Switching the HA mode](#)
- [Cluster level failover IP on page 216](#)
- [Health Check on page 216](#)
- [Using an aggregate interface on page 218](#)

HA cluster pre-requisites

- Primary and secondary units are the same model and configuration. We recommend using FortiSandbox 2000E or higher hardware or FortiSandbox VM with SSD drives as primary and secondary nodes in a cluster with multiple worker nodes.
The worker unit can be a different model and have a different set of Windows VM from the primary or secondary units.
- HA cluster requires all nodes to have port1 to be accessible. Nodes use that port to communicate with each other.
Port1 is the admin port by default. Other available ports can also be used as the admin port.
- Port3 on all nodes should be connected to the Internet separately.
- All nodes should be on the same firmware build.
- Each node should have a dedicated network port for internal cluster communication.
Internal cluster communication is encrypted and includes:
 - Job dispatch
 - Job result reply
 - Setting synchronization
 - Cluster topology broadcasting



The system time must be synched on all nodes in the HA cluster. This prevents out-of-sync job results, logs and statistics. It will also prevent the secondary device from becoming the primary device during reboot.



We recommend that these ports be connected to the same switch and have IP addresses in the same subnet. If the job load is heavy, we recommend using the 10G fiber port as the internal communication port.



Port1 and any other administrative port set through the CLI command `set admin-port` are not recommended to be used as the internal communication port.

Example configuration

This example shows the steps for setting up an HA cluster using three FortiSandbox units.

Step 1 - Prepare the hardware:

Prepare the following hardware:

- Eleven cables for network connections.
- Four 1/10 Gbps switches.
- Three FortiSandbox units with proper power connections (units A, B, and C). In this example, unit A is the primary node, unit B is the secondary node, and unit C is the worker node.



Put the primary and secondary nodes on different power circuits.

Step 2 - Prepare the subnets:

Prepare four subnets for your cluster (customize as needed):

- Switch A: 192.168.1.0/24: For system management.
 - Gateway address: 192.168.1.1
 - External management IP address: 192.168.1.99
- Switch B: 192.168.2.0/24: For internal cluster communications.
- Switch C: 192.168.3.0/24: For the outgoing port (port 3) on each unit.
 - Gateway address: 192.168.3.1
- Switch D: 192.168.4.0/24: For the file submission port (port 4) on the primary and secondary unit.

Step 3 - Setup the physical connections:

1. Connect port 1 of each FortiSandbox device to Switch A.
2. Connect port 2 of each FortiSandbox device to Switch B.
3. Connect port 3 of each FortiSandbox device to Switch C.
4. Connect port 4 of the primary and secondary FortiSandbox device to Switch D.

Step 4 - Configure the primary:

1. Power on the device (Unit A), and log into the CLI.
2. Configure the port IP addresses and gateway address with the following commands:

```
set port1-ip 192.168.1.99/24
set port2-ip 192.168.2.99/24
set port3-ip 192.168.3.99/24
set port4-ip 192.168.4.99/24
set default-gw 192.168.1.1
```
3. Configure the device as the primary node and its cluster failover IP for port1 with the following commands:

```
hc-settings -sc -tM -nPrimaryA -cTestHCsystem -ppassw0rd -iport2
hc-settings -si -iport1 -a192.168.1.98/24
hc-settings -si -iport4 -a192.168.4.98/24
```
4. Review the cluster status with the following command:

```
hc-status -l
```

Other ports on the device can be used for file inputs.

Step 5 - Configure the secondary:

1. Power on the device (Unit B), and log into the CLI.
2. Configure the port IP addresses and gateway address with the following commands:

```
set port1-ip 192.168.1.100/24
set port2-ip 192.168.2.100/24
set port3-ip 192.168.3.100/24
set port4-ip 192.168.4.100/24
set default-gw 192.168.1.1
```
3. Configure the device as the secondary node with the following commands:

```
hc-settings -sc -tP -nSecondaryB -cTestHCsystem -ppassw0rd -iport2
hc-settings -l
hc-worker -a -s192.168.2.99 -ppassw0rd
```
4. Review the cluster status with the following command:

```
hc-status -l
```

Step 6 - Configure the worker:

1. Power on the device (Unit C), and log into the CLI.
2. Configure the port IP addresses and gateway address with the following commands:

```
set port1-ip 192.168.1.101/24
set port2-ip 192.168.2.101/24
set port3-ip 192.168.3.101/24
set default-gw 192.168.1.1
```
3. Configure the device as a worker node with the following commands:

```
hc-settings -sc -tR -cTestHCsystem -ppassw0rd -nWorkerC -iport2
hc-settings -l
hc-worker -a -s192.168.2.99 -ppassw0rd
```
4. Review the cluster status with the following command:

```
hc-status -l
```

Step 7 - Configure client devices to send files to FortiSandbox port4 failover IP:

1. Configure client devices to use unit A port4's failover IP to submit files so that during failover, the new primary node (unit B) port4 will take over that IP.

In FortiGate, enable FortiSandbox and connect it to the port4's failover IP.

```
FGT_208 # config global
config global

FGT_208 (global) # config system fortisandbox

FGT_208 (fortisandbox) # show
config system fortisandbox
    set status enable
    set server "192.168.4.98"
end

FGT_208 (fortisandbox) #
```

- If you enable adapters such as ICAP, BCC, or MTA on the primary port4's failover IP, in adapter's client configuration, you must specify primary port4's failover IP to make adapter clients send traffic to FortiSandbox HA cluster. For example, specify "port4 HA" for "Interface" of settings.

Step 8 - Configure the following settings on each unit:

- In *Scan Policy and Object > VM Settings*, set each unit's clone number.
- Configure *Network* settings such as default gateway, static route, and system DNS.
- In *System > Settings > VM External Network Access* set port3 gateway and DNS server.

Scan related settings, such as the scan profile, should be set on primary unit only; they will be synchronized to the worker node. For details, see [Primary and worker roles on page 223](#).

Scan input related settings should be set on primary node only as only primary node receives input files.



If you use the GUI to change a role from worker to standalone, you must remove the worker from the primary using the CLI command `hc-primary -r<serial number>`; then use `hc-status -l` to verify that the worker unit has been removed.

Switching the HA mode

FortiSandbox HA Cluster supports two operating modes:

- Active-Active Mode (Default):**
Both the primary and secondary nodes perform the cluster scanning tasks, enabling load balancing.
- Active-Passive Mode:**
Secondary nodes do not receive files from the primary node and do not perform the cluster scanning tasks. They operate in hot standby mode.

By default, the FortiSandbox HA Cluster operates in Active-Active Mode. The operating mode can be switched after completing the general HA Cluster configuration using the CLI command: `hc-settings`

To switch the Cluster HA mode using the CLI:

1. Use the following command to display the cluster information, including the current HA mode:
`hc-settings -l`
2. Enter one of the following commands to change the HA mode:
Set the cluster mode to Active-Active:
`hc-settings -sa -a`
OR:
Set the cluster mode to Active-Passive:
`hc-settings -sa -p`

The scan power configuration**Active-Active mode:**

For the cluster scanning tasks, the default scan power is 50% on the primary node and 100% on the secondary node. It can be adjusted using the CLI command `hc-primary` on the primary node.

Active-Passive mode:

For the cluster scanning tasks, the default scan power is 100% on the primary node and 0% on the secondary node. It can also be adjusted using the CLI command `hc-primary` on the primary node. Although the secondary node does not receive or execute cluster scanning tasks, it can still perform scans for tasks specifically sent to it.

After a failover, the scan power will be automatically adjusted based on the node's new role without affecting the HA mode.

Cluster level failover IP

You can configure a cluster level failover IP for each port except port3 and any ports the sniffer is sniffing. This IP set works as an alias IP of the primary node network port. The primary node local IP set and secondary node Local IP set are kept locally during failover.

This failover IP set should be set on the current primary node through the CLI command `hc-settings`. It should be in the same subnet of each port's local IP. Client devices such as FortiGate should point to this failover IP. When a failover occurs, this failover IP set will be applied on the new primary node.

Health Check

HA cluster > Health Check is only available on the primary node. You can use the *Health Check* to set up a ping server and/or echo server to ensure the network condition between client devices and FortiSandbox is always up. If not, the primary node downgrades itself to a secondary node if there is at least one secondary node, a failover occurs after the configured period elapses. If no secondary node exists, the primary node keeps its primary role.

The following options are available:

Create New	Create a new health check ping server and/or echo server.
Edit	Edit a health check ping server and/or echo server.
Delete	Delete a health check ping server and/or echo server.

This page displays the following information:

Interface	The interface port to connect to the ping server and/or echo server. Port3 cannot be used.
Remote Server	IP address or fully-qualified domain name of the remote ping server and/or echo server.
Ping	Enable or disable sending the ping packet to the remote server to ensure the network connection is up.
TCP Echo	Enable or disable sending TCP Echo packet to ensure the network connection to the remote sever is up.
Interval	Time interval in seconds (30-180 seconds) to send a ping or TCP Echo packets.
Failover Threshold	Failover threshold (3-120 times). After a certain number of consecutive missing responses of ping or TCP Echo packets, the primary node will downgrade itself as a secondary if there is an existing secondary node.

To create a new HA Health Check:

1. Go to *HA cluster > Health Check*.
2. Click *Create New* from the tool bar.
3. Configure the settings.
4. Click *Ok*.

To edit a HA Health Check:

1. Go to *HA cluster > Health Check*.
2. Select the Health Check you want to edit.
3. Click the *Edit* button from the toolbar.
4. Edit the settings.
5. Click *Ok*.

To delete a HA Health Check:

1. Go to *HA cluster > Health Check*.
2. Select the Health Check you want to delete.
3. Click the *Delete* button from the toolbar.
4. Click the *Yes, I'm sure* button to delete the Health Check.

Using an aggregate interface

To configure IP addresses on an aggregate interface using the GUI:

1. Go to *System > Interfaces* and click *Create New*.
2. Select the *Interface Members* and set up the IPv4 address and netmask.
3. Click *OK*.
A new interface called *bond1* is created.

To configure IP addresses on an aggregate interface using the CLI:

1. Use the *show* command to display information about all interfaces.
2. Enter the following command.

```
hc-settings -si -ibond1 -a<External IP/NetMask>
```

3. Enter the *show* command again to see the new external IP address.
In the GUI, *System > Interfaces* also displays the new external IP address.

Deploying primary and secondary nodes without VM Clones

When the primary and secondary node are using a FortiSandbox VM00 model, you have the option of deploying without VM Clones (i.e. dispatcher). That VM00 deployment dedicates its full VM resources for HA support, receiving incoming files and distribution of files to the worker nodes. There is no scan performed on the VM00. On this type of VM00 deployment, only the *FortiCare Premium Support* subscription is necessary as all the scans are performed on the worker nodes.

Cluster Management

Use *HA cluster > Cluster Management* to view the basic information of cluster nodes and to manage the cluster.



The total number of cluster members are shown at the bottom of the list. This number cannot exceed 101, including the primary.

The *Cluster Management* section displays all the secondary and worker nodes.

The following information is shown:

Host Name	The host name of the device in the cluster.
------------------	---

Serial Number	The serial number of the device.
Type	The type of the device: <i>Primary</i> , <i>Secondary</i> , or <i>Worker</i> .
Alias	The device's alias.
Version	The software version of the device.
IP Address	The device's internal communication IP address.
Pending Jobs	The number of pending jobs of the device.
Status	The status of the device: <i>Active</i> or <i>Inactive</i> .

Use the buttons in this section to manage the cluster.

To manage the cluster:

1. Go to *HA cluster > Cluster Management*.
2. (Optional) Click *Refresh* to get the latest cluster information. The cluster information is refreshed automatically every three seconds.
 - Select one unit and click *View Dashboard* to display that unit's Dashboard.
 - Select one or more units and click *Upgrade Firmware* to upload a firmware image to upgrade the selected units. The firmware image must be in *.out* or *.deb* format.
 - Select one or more units and click *Upload Fortiguard* to upload a package file to the selected units.
 - Click *Backup All* to back up the configuration file of all cluster units (including the primary unit) to an archive file. The backup archive file is named with the cluster name and the date and time.
 - Select one or more units and click *Purge Jobs* to delete the selected units' pending jobs.
 - If a node is running a different version from the primary node, there is an information icon which tells you that the firmware version is not compatible with the primary node.

Synchronization

Use the *Synchronize Settings In Real-Time From Primary To Other Nodes* section to set synchronization options.

To set cluster synchronization options:

1. Go to *HA cluster > Cluster Management*.
2. In the *Synchronize Settings In Real-Time From Primary To Other Nodes* section, select what to synchronize with secondary and worker nodes.
3. Click *Synchronize Now*.



When the *Administrators, Admin Profiles, User Password Policy, Device Groups, Netshare Groups, LDAP/RADIUS Servers, Certificates* option is selected under *Synchronize Settings In Real-Time From Primary To Other Nodes*:

- On the Primary node, only the admin user can view and edit all user accounts.
- On a non-Primary node, the admin user can view all accounts but cannot edit them.
- All other users on a non-Primary node can view only their own account and cannot make any changes.
- All changes to these settings should be made on the Primary node only.

Access privilege

To set access privilege for the Cluster Management page:

1. Go to *System > Admin Profiles* to the *HA Cluster* section.
2. Set the privilege for *Cluster Management/Status*.
Read Write privilege allows access to all functions on this page.
Read Only privilege allows *view only* on this page.

Job Summary

HA cluster > Job Summary shows job statistics data of each node in a cluster. It is only available on the primary node.

To view a HA Job Summary:

1. Go to *HA cluster > Job Summary*.
2. Select either *File* or *URL* button to view file-based scan results and URL scan results.
The following information is shown:

Time Period Drop down	Select the period of time over which the data was collected from the dropdown. You have the following options: <i>Last 24 Hours, Last 7 Days, and Last 4 Weeks</i> .
Serial Number	The serial number of the device in the cluster.
Pending	The number of files in the job queue waiting to be scanned.
Malicious	The number of malicious files detected.
Suspicious	The number of suspicious files detected.
Clean	The number of clean files detected.
Other	Other files that have been scanned and have an Unknown rating.

Select a number from the *Malicious, Suspicious, Clean, or Other* columns to view details about those specific files.

3. Click *Refresh* at the top-left corner of the page to refresh job summary numbers (*Pending, Malicious, Suspicious, Clean, or Other*).

Managing worker nodes

On a primary node, you can select a worker to view and manage information pertaining to that worker. In the *Dashboard*, all the configured widgets will be displayed, for example: System Information, Connectivity and Services, System Resources including Disk Usage, Scan Statistics, etc.

To manage worker nodes on the primary node:

1. Go to *HA cluster*.
2. Select the worker node's serial number.
3. You can perform the following tasks:View the worker node's dashboard.
 - View the worker node's dashboard.
 - Change the worker node's role using the Dashboard > System Information widget.
 - Upgrade the worker node's Firmware and upload the License for the worker node.
 - Configure the worker node's network settings (such as its Interface IP address, routing table, DNS).
 - Configure the worker nodes' VM Network settings for VM outgoing traffic through port3.
 - View and configure the worker node's FortiGuard configuration.
 - View the worker node's VM Jobs page.
 - View and configure the worker node's VM Settings.

HA Roles, Synchronization and Failover

The primary node and secondary node send heartbeats to each other to detect if its peers are alive. If the primary node is not accessible, such as during a reboot, a failover occurs. You can also configure a ping server and/or echo server to regularly check the unit's network condition and downgrade itself to secondary type to trigger a failover. In a failover, the secondary and primary switch roles and the cluster IP addresses change, as indicated by the boxes in the lower image.

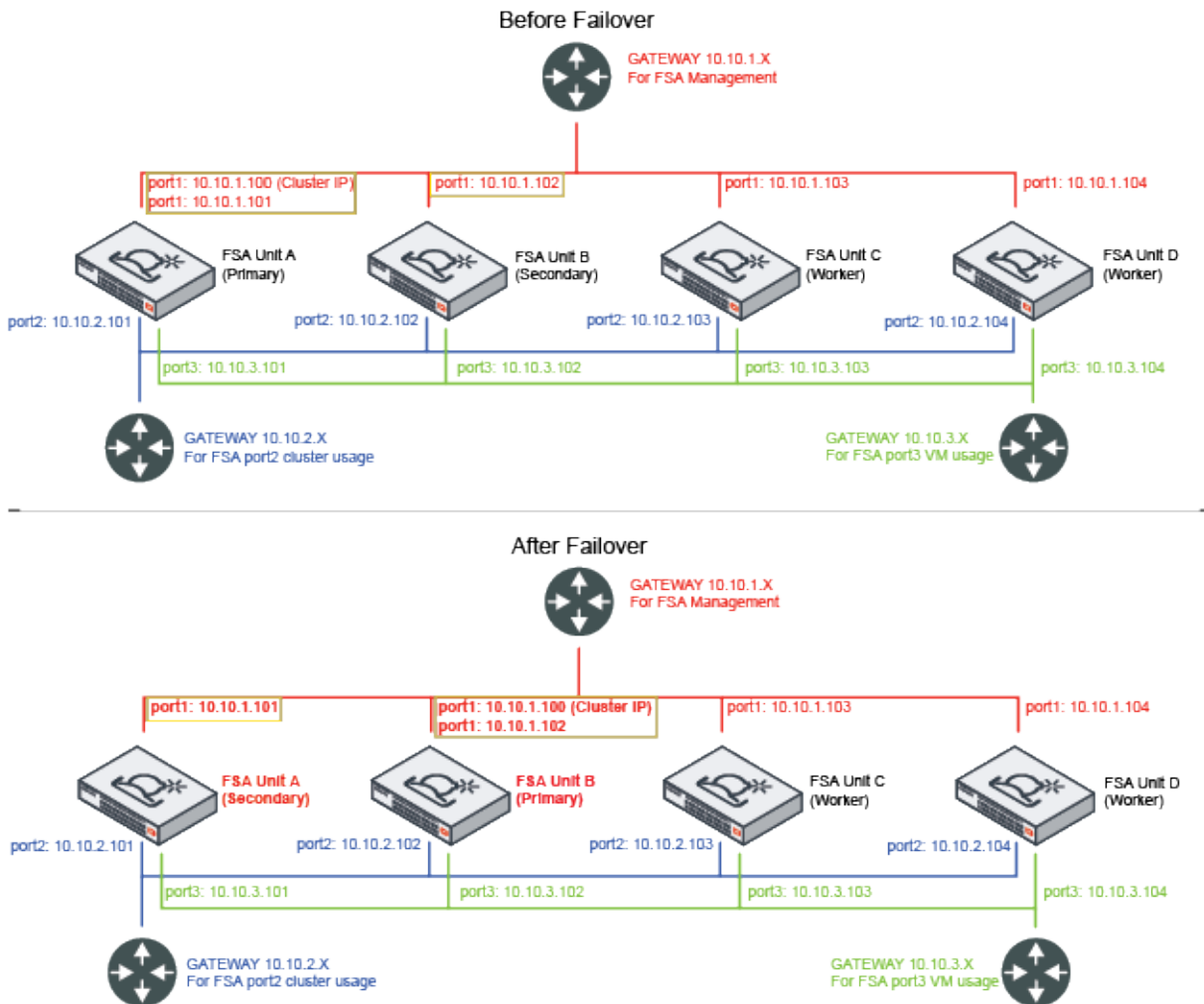

In a cluster, there is only one copy of a job, which is in the unit that the primary assigned it to. Jobs that are assigned to the "old" primary will not be scanned in another cluster unit after failover.

Primary and worker roles

On the primary node, all functionality is available based on your licenses and contracts. This includes accepting files from different input sources, sending alert emails, and generating malware packages. Scan profiles should also be configured on the primary node and will be synchronized to other nodes.

The following table lists the features and its synchronization settings.

- **Failover:** The related settings are synchronized from primary to secondary during failover.
- **Realtime:** The related settings are synchronized as soon as changes are applied.
- **Realtime*:** The related settings are synchronized in realtime only if configured.

Feature	Secondary	Worker
Dashboard > Status		
Widget settings	Failover	
NTP Server settings	Failover	
Security Fabric		
Device, including FortiClient	Failover	
Adapter	Failover	
Network Share, including network share scans	Failover	
Quarantine	Failover	
Sniffer	Failover	
FortiNDR	Realtime	Realtime
HA cluster		
Health Check	Failover	
Scan Job		
Overridden job verdicts	Realtime	Realtime
Scan Policy and Object		
Scan Profile > Pre-Filter	Realtime	Realtime
Scan Profile > Advanced	Realtime	Realtime
Job Queue Priority	Realtime	Realtime
Allowlist/Blocklist	Realtime	Realtime
YARA Rules	Realtime	Realtime
Web Category	Realtime	Realtime
Customized Rating	Realtime	Realtime
Global Network settings	Failover	

Feature	Secondary	Worker
Threat Intelligence > Generation Settings	Failover	
System		
Administrators	Failover/Realtime*	Realtime*
Device Groups	Failover/Realtime*	Realtime*
Netshare Groups	Failover/Realtime*	Realtime*
Password Policy	Failover/Realtime*	Realtime*
Certificates	Failover/Realtime*	Realtime*
LDAP Servers and RADIUS Servers	Failover/Realtime*	Realtime*
Network settings (DNS)	Realtime*	Realtime*
Mail Server, including Scheduled Report Configuration	Failover	
SNMP	Failover/Realtime*	Realtime*
FortiGuard	Realtime*	Realtime*
Login Disclaimer	Realtime*	Realtime*
System Recovery	Failover/Realtime*	Realtime*
Admin Profiles Failover	Realtime*	Realtime*
SAML SSO	No	
Settings > Idle Time	Failover	
Settings > Language	Failover	
Settings > Alarm	Failover	
Settings > Allow VMs outbound port3	Realtime*	Realtime*
Settings > Data Storage	Realtime	Realtime
Settings > Download of Original Files	Realtime	Realtime
Log & Report		
Log Servers	Realtime*	Realtime*
Local Log	Realtime*	Realtime*
Setting s> Report Retention	Failover	
CLI only configuration		
AI Mode	Realtime	Realtime
Device Low-Encryption	Failover	
Device Authorization	Failover	

Feature	Secondary	Worker
File size limit configuration	Realtime	Realtime
FortiMail expired timeout	Failover	
Network settings (proxy and routing tables)	Realtime*	Realtime*
HA Cluster settings (encryption)	Realtime	Realtime
OFTPD conserve mode	Failover	
Primary node scan power	Failover	
Prescan configuration	Realtime	Realtime
Remote authentication timeout	Failover	
TLS version	Realtime	Realtime
Sandboxing embedded URL	Realtime	Realtime
FortiMail Url Recheck	Realtime	Realtime



Although you can assign different VM types to each node in a cluster, we recommend all nodes share the same VM types. VM types are collected from all nodes and are displayed in the primary node's *Scan Profile > VM Association* page where VM associations can be configured and synchronized for the entire cluster. If an association for a VM type is missing on the worker node, the sandbox scan cannot be completed.

For example, if you associate WIN10X64VM to scan all executable files when configuring the Scan Profile on the Primary node, but do not enable WIN10X64VM on a Worker node, all executable files distributed to that worker are not scanned by VM.

Heartbeat Synchronization

Primary and secondary nodes in a cluster send heartbeats to each other every half second. When a secondary node fails to receive a single heartbeat from the primary node, it will consider the primary node to be off-line or unreachable. This can happen on the primary node due to a network problem or when it is rebooting. When the primary is unreachable, a selection process for a new primary node will be triggered. The selection is promptly performed and decided based on the health of the nodes. When a secondary node is selected, all other secondary nodes will treat it as the new primary node and the failover process will start.

The heartbeat can also fail due to an issue with the secondary node. In that case, the selection process is still triggered but the primary node remains the same.

Failover scenarios

The failover logic handles two different scenarios:

Objective node available	<p>The objective node is a worker (either secondary or worker) that can decide the new primary. For example, if a cluster consists of one primary node, one secondary node, and one worker node, the worker node is the objective node.</p> <p>After a secondary node takes over the primary role, the original primary node will accept the decision when it is back online.</p> <p>After the original primary is back online, it will become a secondary node.</p>
No Objective node available	<p>When there is no objective node in the cluster, the cluster topology is not stable and the failover process may take several rounds of role changes. This occurs when there is no communication between nodes because the cluster's internal communication is down . During the failover process, the final roles of primary and secondary are decided by three principal factors: the internal connections, the health check, and the serial number.</p> <p>Internal Connections</p> <p>The internal connections in a cluster involve two ports: port1 and the cluster internal port, typically port2 depending on your configuration.</p> <p>Port1 is used when a node prompts itself to be the primary and needs confirmation from other nodes.</p> <p>The cluster internal port is used for cluster nodes to detect whether its connection to other nodes in the cluster is available or not, and is used to ask the secondary to failover when its health check fails.</p> <p>Health Check</p> <p>The health check is used to check the connection with the ping server and/or echo server. If this connection fails in the primary node, it triggers a failover.</p> <p>Serial Number</p> <p>Once the port1 connection is recovered, the unit with the newer serial number will keep the primary role and the unit with the older serial number will become the secondary.</p>

When the new primary is decided, it will:

1. Build up the scan environment.
2. Apply all the settings synchronized from the original primary except the port3 IP and the internal communication port IP of the original primary.

After a failover occurs, the original primary might become a secondary node.

It keeps its original port3 IP and internal cluster communication IP. All other interface ports are shut down as it becomes a worker node. Some functionality is turned off such as email alerts. If you want to reconfigure settings, such as the interface IP, you must do that through the CLI command or the primary's Central Management page.



Do not change the new primary node's configuration before the old primary node has returned online, because there is a risk the configuration could be lost. If it is absolutely necessary to reconfigure the new primary, it is recommended to first remove the old primary from the cluster using the CLI command `hc-primary -r`.

As the new primary takes over the port that client devices communicate with will switch to it. As the new primary needs time to start up all the services, clients may experience a temporary service interruption.

Performance tuning

Setting primary node processing capacity

Primary node requires enough dedicated processing power for job distribution and cluster management. We recommend that for every 5 VM clones on the worker nodes, 1 VM should be removed from the Master.

Example

You are using two FSA3KE units to setup a cluster. One FortiSandbox works as Primary node and the other works as the Worker node.

The Worker node operates 56 VM clones, so the Primary node should remove 11 clones from its processing capacity. In this example, the Primary node should be running 45 (56 – 11) VM clones.

The CLI command `hc-primary -s80` will take the Primary node to 80% of its VM processing power, which is 45 clones. This means that even if you configure the Primary node to run 56 clones, at any moment, no more than 45 clones can be running.

Upgrading or rebooting a cluster

Upgrading or rebooting a cluster has to be done by logging into each device or through the primary unit's *Cluster Management* page. You must upgrade the cluster in the following order:

1. Workers
2. Secondary
3. Primary



It is highly recommended to setup cluster level failover IP set so the failover between primary and secondary can occur smoothly. If you do not want the failover to happen, you can change the secondary unit role to worker. You can either do this through the UI dashboard or the CLI prior to the failover, then change the role back after the unit boots up.

Main HA cluster CLI commands

The table below lists the CLI commands to administer your HA cluster.

<code>hc-settings</code>	Configure the unit as a HA cluster mode unit. Set or unset cluster failover IP set.
<code>hc-status -l</code>	List the status of HA cluster units.
<code>hc-worker</code>	-a to add that worker or secondary unit to the cluster. -r to remove that worker or secondary unit from the cluster. -u to update that worker or secondary unit information.
<code>hc-primary -s<10-100></code>	Turn on file scan on the primary node with 10% to 100% processing capacity.
<code>hc-primary -r<serial number></code>	Remove the worker or secondary unit with the specified serial number from the primary node.

After removing a worker or secondary node, use `hc-status -l` on the primary node to verify that the worker or secondary node has been removed.

Log & Report

Use the Log & Report page to view and download all logs collected by the device, access scheduled reports, and generate reports. You can see logs local to FortiSandbox, or set up a remote log server, such as one linking to FortiAnalyzer.



Local logs retain up to 1 GB of overall logs. If this limit is reached, logs are rotated to keep the latest ones.

Log Details

To view more details about a specific log in the log list, simply select that log. A log details pane is available at the bottom of the window.

The log details pane contains the same information as the log message list, except with a full message in lieu of a shortened one.

Logging Levels

FortiSandbox logs can be Emergency (reserved), Alert, Critical, Error, Warning, Information, or Debug. The following table provides example logs for each log level.

Log Level	Description	Example Log Entry
Alert	Immediate action is required.	Suspicious URL visit domain.com from 192.12.1.12 to 42.156.162.21:80.
Critical	Functionality is affected.	System database is not ready. A program should have started to rebuild it and it shall be ready after a while.
Error	An erroneous condition exists and functionality is probably effected.	Errors that occur when deleting certificates.
Warning	Functionality might be affected.	Submitted file AVSInstallPack.exe is too large: 292046088.
Information	General information about system operations.	LDAP server information that was successfully updated.

Log Level	Description	Example Log Entry
Debug	Detailed information useful for debugging purposes.	Launching job for file. jobid=2726271637747836543 filename=log md5=ebe5ae2bec3b653c2970e8cec9f5f1d9 sha1=06ea6108d02513f0d278ecc8d443df86dac2885b sha256=d678da5fb9ea3ee20af779a4ae13c402585ebb 070edcf20091cb20509000f74b

Raw logs

You can download and save raw logs to the management computer using the *Download Log* button. Raw logs are saved as a text file with the extension *.log.gz*. You can search the system log for more information.

Sample raw logs file content

```
itime=1458669062 date=2016-03-22 time=17:51:02 logid=122000020 type=event subtype=unknown pri=alert
user=system ui=system action=rating status=success reason=none letype=6 msg=fname=v32.cab
jobid=2725911139058114340 sha1=f61045626e5f4f74108fb6b15dde284fe0249370
sha256=f75fca6300e48ec4876661314475cdd7f38d4c73e87dfb5a423ef34a7ce0154f rating=Clean
scantime=11 malwarename=N/A srcip=204.79.197.200 dstip=208.91.115.250 protocol=HTTP device=()
url=http://officecdn.microsoft.com/pr/492350f6-3a01-4f97-b9c0-c7c6ddf67d60/Office/Data/v32.cab
itime=1458669062 date=2016-03-22 time=17:51:02 logid=010600001 type=event subtype=system pri=debug
user=system ui=system action=controller status=success reason=none letype=6 pid=8605
msg="Sandboxing environment is not available for job 2725913445926977878, file type: htm, file
extension: htm"
itime=1458669062 date=2016-03-22 time=17:51:02 logid=122000020 type=event subtype=unknown pri=alert
user=system ui=system action=rating status=success reason=none letype=6 msg=fname=0_22_93_0_0_
2_0_0_1.html jobid=2725913445926977878 sha1=098a2ca8d81979f2bb281af236f9baa651d557d5
sha256=424c62eaaa4736740e43f5c7376ec6f209b0d3df0e0cadcc94324280eafa101f rating=Clean
scantime=12 malwarename=N/A srcip=125.39.193.250 dstip=208.91.115.12 protocol=HTTP device=()
url=http://all.17k.com/lib/book/0_22_93_0_0_2_0_0_1.html
```



For detailed log format information, please refer to the *FortiSandbox 5.0.3 Log Reference* available on the [Fortinet Document Library](#).

Log Categories

Logs are grouped into the following categories:

All Events	All logs.
System Events	Logs related to system operation, such as user creation and FDN downloads.
VM Events	Logs related to guest VM systems, such as VM initialization.

Job Events	Logs related to scans. You can trace the scan flow of each file or URL.
HA cluster Events	Logs related to cluster configuration and failovers.
Notification Events	Logs related to email alerts and SNMP traps.

History Logs

#	Date/Time	Level	User	Message
1	2016-03-01 12:06:14	debug	system	HC: distributed file to unit FSA3KD3R13000001 (master itself), sha256=db726186ae7a48cbc5fdecfb1ed74164eca66cb021c82fed5b186...
2	2016-03-01 12:06:14	debug	system	HC: distributed file to unit FSA3KD3R13000001 (master itself), sha256=bdb781a171f405a5db9daf0b775ba16e3d9d90a9ea84abf867...
3	2016-03-01 12:06:14	debug	system	HC: distributed file to unit FSA3KD3R13000001 (master itself), sha256=f9d1e4ddea48b41df0f3c9cb96939195349c77fb6efd66d1d4a4...
4	2016-03-01 12:06:14	debug	system	HC: distributed file to unit FSA3KD3R13000001 (master itself), sha256=81cc1b42edcc03e3a335651dc6296ac0f38360c70334d9eee6...
5	2016-03-01 12:06:14	debug	system	HC: distributed file to unit FSA3KD3R13000001 (master itself), sha256=dc5b2a59fddf3f64b8d8b61dc978af3ba45910e73f0c0c7c32173...
6	2016-03-01 12:06:14	debug	system	HC: distributed file to unit FSA3KD3R13000001 (master itself), sha256=4388620b7ee1a7d3468fb0bac72ec6800deef9e2039e9fa4cd68...
7	2016-03-01 12:06:14	debug	system	HC: distributed file to unit FSA3KD3R13000001 (master itself), sha256=c9d6be39edbf46084af2e6e8f5f06ef000f33217f11dd89d7fbb3...
8	2016-03-01 12:06:14	debug	system	HC: distributed file to unit FSA3KD3R13000001 (master itself), sha256=b399e0631bb16bf6fb1f596c1c16158f3a31e43409d8d2d39fb8f...
9	2016-03-01 12:06:14	debug	system	HC: distributed file to unit FSA3KD3R13000001 (master itself), sha256=82a321031c0f9c44acf253c7f98f6bada792a0e9fc241f794e66e...
10	2016-03-01 12:06:14	debug	system	HC: distributed file to unit FSA3KD3R13000001 (master itself), sha256=497bf0734786d19ac7ead2a25dffcc3584cef26023b3b98c157c...
11	2016-03-01 12:06:14	debug	system	HC: distributed file to unit FSA3KD3R13000001 (master itself), sha256=160927dbb11b4cc3ec38a25a7a9ae12b1ebddc8bc214312853...

The following options are available:

Download Log	Download a file containing the raw logs to the management computer.
History Logs	Enable to include historical logs in Log Search.
Refresh	Refresh the log message list.
Add Search Filter	Add search filters. You can select different categories to search the logs. Search is not case sensitive.
Pagination	Jump or scroll to other pages. You can see the total number of pages and logs.

The following information is displayed:

#	Log number.
Date/Time	Time the log message was created.
Level	Level of the log message. Logging levels are: <ul style="list-style-type: none"> Alert: Immediate action is required. Critical: Functionality is affected. Error: Functionality is probably affected. Warning: Functionality might be affected. Information: Information about normal events. Debug: Information used for diagnosis or debugging.
User	The user to which the log message relates. User can be a specific user or system.
Message	Detailed log message.
Action	Action that was taken on the operation, such as <i>Update</i> , <i>Controller</i> , <i>Rescan</i> , and so on.
Status	Status of the log, such as <i>None</i> , <i>Success</i> , or <i>Failure</i> .
User Interface	User interface that was used, such as <i>GUI</i> or <i>System</i> .

Viewing logs in FortiAnalyzer

To view FortiSandbox logs in your FortiAnalyzer:

1. Log into FortiAnalyzer.
2. In the *Select an ADOM* prompt, select FortiSandbox.
3. Click the *Log View* tile.

The following options are available:

Add Filter	Enter a search term to search the log messages. You can also right-click an entry in a column and select to add a search filter. Click <i>GO</i> to apply the filter. Not all columns support the search feature.
Device	Select the device in the dropdown list.
Time Period	Select a time period from the dropdown list. Options include: <i>Last 30 mins</i> , <i>Last 1 hour</i> , <i>Last 4 hours</i> , <i>Last 12 hours</i> , <i>Last 1 day</i> , <i>Last 7 days</i> , <i>Last N hours</i> , <i>Last N days</i> , or <i>Custom</i> .
GO	Select to apply the time period and limit to the displayed log entries. A progress bar is displayed in the lower toolbar.
Column Settings	Select specific columns to be displayed. You can also reset the columns to its default.
Tools	<i>Tools</i> has options for changing how to display logs, options for search, and to add or delete column.
Real-time Log	FortiSandbox does not support <i>Real-time Log</i> .
Display Raw	Select to change view from formatted display to raw log display.
Download	This option is only available when viewing logs in formatted display. Click to download logs. Select the log file format, then compress with gzip the pages to include and select <i>Apply</i> to save the log file on the management computer.
Case Sensitive Search	Select to enable case sensitive search.
Chart Builder	Select to create a custom chart.
Display Details button	Detailed information about the log message selected in the log message list. The item is not available when viewing raw logs. <i>Log Details</i> are only displayed when enabled in the <i>Tools</i> menu.
Search Scope	Select the maximum number of log entries to be displayed from the dropdown list. Options include: <i>1000</i> , <i>5000</i> , <i>10000</i> , <i>50000</i> , or <i>All</i> .

This page displays the following information:

Logs	The columns and information shown in the log message list will vary depending on the selected log type and the view settings. Right-click various columns to add search filters to refine the logs displayed. When a search filter is applied, the value is highlighted in the table and log details.
Status Bar	Displays the log view status as a percentage.
Pagination	Adjust the number of logs that are listed per page and browse through the pages.

Customizing the log view

The message column can display raw or formatted logs. The columns in the log message list can be customized to show only relevant information in your preferred order.

By default, formatted logs are displayed. The selected log view will affect available view options. You cannot customize the columns when viewing raw logs.

To view raw logs:

Go to *Tools* and select *Display Raw* from the dropdown menu from the toolbar.

To view formatted logs:

Go to *Tools* and select *Display Formatted* from the dropdown menu from the toolbar.

Columns

The columns displayed in the log message list can be customized and reordered as needed. Filters can also be applied to the data in a column.

To customize the displayed columns:

1. In the log message list view, click *Column Settings* in the toolbar.
2. From the dropdown list that is displayed, select a column to hide or display.



The available column settings will vary based on the device and log type selected.

3. To add more columns, select *More Columns*. In the *Column Settings* dialog box that opens, you can show or hide columns by selecting and deselecting the columns.
4. To reset to the default columns, click *Reset to Default*.
5. Click *OK* to apply your changes.

To change the order of the displayed columns:

Place the pointer in the column header area, and then move a column by dragging and dropping.

To filter column data:

1. You can filter log summaries by using the *Add Filter* box in the toolbar or by right-clicking an entry and selecting a context-sensitive filter.
2. Specify filters in the *Add Filter* box.
Use Regular Search. In the selected summary view, click in the *Add Filter* box, select a filter from the dropdown list, and type a value. You can click on an operator to use it, such as greater than (>), less than (<), OR, and NOT. You can add multiple filters at a time, and connect them with "and" or "or".
Use Advanced Search. Click the Switch to Advanced Search icon at the end of the Add Filter box. In Advanced Search mode, you provide the whole search criteria (log field names and values) by typing. Click Switch to Regular Search icon to go back to regular search.
Case-sensitive search. Use the *Tools* dropdown list to specify case-sensitive search.
3. In the Device list, select a device.
4. In the Time list, select a time period.
5. Click *Go*.

To filter log summaries using the right-click menu:

In the log message list, right-click an entry, and select a filter criteria. The search criteria with a + (plus) icon returns entries that match the filter values, while the search criteria with a - (minus) icon returns entries that negate the filter values.

Right-click a column for Log View to use that column value as the filter criteria. This context-sensitive filter is not available for all columns.



For more information, see the *FortiAnalyzer Administration Guide* in the [Fortinet Document Library](#).

Summary Reports

The *Summary Reports* page lists all Executive Summary and Threat Activity reports including their status, and the user who generated the report. You can download and delete the PDF reports.

Report pages are not visible on the worker node in a cluster.

Generate reports

To generate a summary report on demand, go to *Logs & Reports > Summary Report*.

You can generate executive summary and threat activity reports for a specified time period.

The following options are available:

Generate Report	Generate a report.
Download Report	Download a report.
Refresh	Click the button to refresh the entries displayed.
Delete	Delete a report.

This page displays the following information:

Time Period	Time period of data the report includes.
Report Type	Type of report.
Size	Report size.
Status	Status of the report.
User	Who generated the report.

Report Center

When a report is generated, you have the option waiting until the report is ready to view or viewing the report later on the *Report Center* page.

This *Report Center* page displays the following information:

Status	The status of report generation process: Done, Stopped, or In Progress.
Start Time	The time report generation starts.
Finish Time	The time report is ready.
Report Type	The type of report: PDF or CSV.
Report Size	The size of the report.
Download Count	The number of times that the report has been downloaded.
Progress	Percentage that the report has finished
Source	The location that the report is scheduled to generate.
Detection Period	The time range of the jobs that this report contains.
Actions	You can view detailed information, stop report generation, delete, and download the report.
Pagination	Adjust the number of reports that are listed per page and browse through the pages. When you click on any entry on this page, detailed information about the report is displayed, including the job filtering criteria.

Customize Report

Admins with Read/Write privileges can customize the report title, header and footer. You can also add a logo and background image to your report.

Customized Report settings are supported in the following reports:

- Detail Report
- On Demand Detail Job List Report
- Scan Detail Job List Report
- Scheduled Summary Report
- Network Alerts Report



Customize Reports is only available in the Primary node of an HA cluster.

To customize the report settings:

1. Go to *Log & Report > Customize Report*.
2. Configure the report settings and click *Save*.

Report Title	Enter the report title.
Header	Enter the header text.
Footer	Enter the footer text.
Upload logo file	Maximum file size is 1MB.
Upload background file	Maximum file size is 4MB.
Print Appendix System Information	Select this option to include an appendix of the system information.
Details	<ul style="list-style-type: none"> • <i>Include All</i>: All detailed behavior will be printed including <i>Malicious</i>, <i>Suspicious</i>, and <i>Clean</i> ratings. If no behavior is detected, then <i>No Behavior was detected</i> is printed. • <i>Exclude "Clean" rating</i>: The detailed behavior for jobs that are rated <i>Clean</i> are excluded from the report and <i>No Behavior was detected</i> is printed. The behavior for jobs that are rated <i>Suspicious</i> or <i>Malicious</i> is printed.
Print screenshot	Select this option to include screenshots taken during dynamic scan (if available) in the PDF report.

Network Alerts

Network alerts show detected connection attempts to known botnets, attacks to hosts on your network, and harmful websites visited from your network.

To view network alerts (Attacker, Botnet, and URL), go to *Network Alerts*. You can drill down the information displayed and apply search filters. You can select to create a PDF or CSV format snapshot report for specific types of network alert files. Search filters will be applied to the detailed report and will be displayed in the Filtering Criteria section.

Detected	Backdoor	Source	Destination
Mar 01 2016 12:02:21	backdoor: Nitol.Botnet	208.91.115.11	50.63.202.40
Mar 01 2016 12:02:11	backdoor: Nitol.Botnet	208.91.115.11	50.63.202.40
Mar 01 2016 12:01:38	backdoor: Nitol.Botnet	208.91.115.11	50.63.202.40
Mar 01 2016 12:01:07	backdoor: Nitol.Botnet	208.91.115.11	50.63.202.40
Mar 01 2016 11:58:42	applications3: Malicious.JavaScript.Obfuscation.Code.Packer.Detection	190.36.171.72	208.91.115.10
Mar 01 2016 11:58:04	backdoor: Nitol.Botnet	208.91.115.11	50.63.202.40

This page has the following options:

Time Period

Select the time period from the dropdown list. Select one of the following: *24 Hours*, *7 Days*, or *4 Weeks*.

You can select the time period to filter the information displayed in the GUI. This selection is also applied to exported data for the snapshot report.

Alert Type

Select Attacker, Botnet, or URL from the dropdown list. You can select the alert type to filter the information displayed in the GUI. This selection is also applied to exported data for the snapshot report.

Attacker

Shows attacks against hosts on your network. When selecting *Attacker* from the dropdown list, the following information is displayed:

- Detected: The date and time that the attack was detected by FortiSandbox.
- Backdoor: The name of the attack.
- Source: The attacker's IP address.
- Destination: The attacked host IP address.

All columns include a filter to allow you to sort the entries in ascending or descending order.

Botnet

Shows detected connections to known botnets. When selecting *Botnet* from the dropdown list, the following information is displayed:

- Detected: The date and time that the botnet contact was detected by FortiSandbox.
- Name: The botnet name.
- Source: The IP address of the infected host.
- Destination: The botnet command and control IP address.

The *Detected*, *Name*, and *Source* columns include a filter to allow you to sort the entries in ascending or descending order.

URL	<p>Shows visited suspicious websites from your network. When selecting <i>URL</i> from the dropdown list, the following information is displayed:</p> <ul style="list-style-type: none"> • Detected: The date and time that the malicious URL was visited. • Rating: The severity of the visiting activity. • Category: The URL's web filtering category. • Host: The host IP address. The first level domain name of the URL. • URL: The visited URL address. • Type: The URL type, http or https • Source: The IP address of the host who visited the malicious URL. <p>The <i>Detected</i>, <i>Category</i>, <i>Hostname</i>, <i>URL</i>, <i>Type</i>, and <i>Source</i> columns include a filter to allow you to sort the entries in ascending or descending order.</p> <p>Tooltip: Certain URL categories are set as <i>Benign</i> by default. To view and change, go to <i>Scan Policy and Object > Web Category</i>.</p>
Export Data	Select to create a PDF or CSV snapshot report. The time to generate the report is dependent on the number of events selected. You can wait till the report is ready to view, or navigate away and find the report later on the <i>Log & Report > Report Center</i> page.
Refresh	Click the icon to refresh the log message list.
Search	Show or hide the search filter field.
Add Search Filter	Click the search filter field to add search filters. Click the close icon in the search filter field to remove the search filter. Search filters can be used to filter the information displayed in the GUI.

To create a snapshot report for all network alert files:

1. Select a time period from the first dropdown list.
2. Select Attacker, Botnet, or URL from the second dropdown list.
3. Select to apply search filters to further drill down the information in the report.
4. Click the *Export Data* button in the toolbar. The *Report Generator* window opens.
5. Select either PDF or CSV for the report type.
6. Click the *Generate Report* button to create the report.
When the report generation is completed, select the *Download* button to save the file to your management computer.
7. You can wait till the report is ready to view, or navigate away and find the report later on the *Log & Report > Report Center* page.



If *Delete all traces of jobs of Malicious or Suspicious rating after* is configured in *System > Settings*, the network alert records will be deleted after the specified time. Otherwise, the record deletion period is 32 days.

Log Servers

FortiSandbox logs can be sent to a remote syslog server, common event type (CEF) server, FortiAnalyzer, or FortiAnalyzer Cloud. Go to *Log & Report > Log Servers* to create new, edit, and delete remote log server settings. You can configure up to 30 remote log server entries.



Logs are transmitted instantly. If connectivity to the Log Server is interrupted, FortiSandbox will cache the logs in its buffer and attempt to resend later. The log buffer capacity is 1024 logs. Newer logs are discarded when the buffer is full.

The following options are available:

Create New	Create a new log server entry.
Edit	Edit the selected log server entry.
Delete	Delete the selected log server entry.

This page displays the following information:

Name	Name of the server entry.
Type	Server type. The following options are available: CEF, syslog (TCP/UDP), FortiAnalyzer or FortiAnalyzer-Cloud.
Log Server Address	Log server address.
Port	Log server port number.
Status	Status of the log server, <i>Enabled</i> or <i>Disabled</i> or <i>Expired</i> (for FortiAnalyzer Cloud only).

To create a new server entry:

1. Go to *Log & Report > Log Servers*.
2. Click *Create New*.
3. Configure the following settings:

Name	The name of the new server entry.
Type	Select the log server type from the dropdown list.
Log Server Address	Enter the log server's IP address or FQDN.
Log Server Cloud Token	If the <i>Type</i> is <i>FortiAnalyzer Cloud</i> , you must create an Access Token in FortiAnalyzer Cloud and enter it here.
Account ID	After creating the FortiAnalyzer Cloud entry, the Account ID can be viewed by clicking <i>Edit</i> for this entry.

Expiration Date	After creating the FortiAnalyzer Cloud entry, you can view the token expiration date by clicking <i>Edit</i> . The token expires in 90 days. Once expired, please renew the token in FortiAnalyzer Cloud and enter the new token into the <i>Log Server Cloud Token</i> field.
Port	Port number. The default port is 514. If the <i>Type</i> is set to <i>FortiAnalyzer</i> or <i>FortiAnalyzer Cloud</i> , the port field cannot be edited.
Secure Connection	Select to enable or disable encrypted communication between FortiSandbox and the syslog server.
Status	Select to enable or disable encrypted communication between FortiSandbox and the syslog server.
Log Level	Select the logging levels to be forwarded to the log server. The following options are available: <ul style="list-style-type: none"> • Enable Alert Logs. By default, only logs of non-Clean rated jobs are sent. To send Clean Job Alert Logs, select <i>Include job with Clean Rating</i>. • Enable Critical Logs • Enable Error Logs • Enable Warning Logs • Enable Information Logs • Enable Debug Logs

4. Click *OK*.



You can forward FortiSandbox logs to a FortiAnalyzer or FortiAnalyzer Cloud. The Syslog server supports IPv6.

To edit or delete a log server:

1. Go to *Log and Report > Log Servers*.
2. Select an event entry.
3. Click *Edit* or *Delete*.

Settings (Log & Report)

Use the following settings to show or hide logs in *Log & Report > Events*.

Report Retention

Report Saving Days: 8 days (1-28 days) Specify the number of days to retain reports. The default is 8 days.

Log Level	Local logs can retain up to 1GB of data. You can disable logging for specific severity levels to manage storage efficiently.
Log submission events from the following sources	Enable to log the file submission events of an input source.
Devices	Select to log the file submission events of a device, like FortiGate, FortiMail, or FortiClient.
Network Share	Select to log the file submission events from a network share
ICAP	Select to log the file submission events from an ICAP client.
BCC Adapter	Select to log the file submission events from a BCC client.
MTA Adapter	Select to log the file submission events from a MTA client.
Diagnostic Logs	Allow the FortiSandbox support team to collect information for troubleshooting purposes.
Kernel Logging	Enable to record and view system internal logs.
CLI Logging	Enable to record and view CLI histories.

Appendix A - Advanced deployment scenarios

Deploying primary and secondary nodes without VM Clones

When the primary and secondary node are using a FortiSandbox VM00 model, you have the option of deploying without VM Clones (i.e. dispatcher). That VM00 deployment dedicates its full VM resources for HA support, receiving incoming files and distribution of files to the worker nodes. There is no scan performed on the VM00. On this type of VM00 deployment, only the *FortiCare Premium Support* subscription is necessary as all the scans are performed on the worker nodes.

Deploying for Static Scan only

The Static Scan only deployment type provides the highest available performance and lowest scan time to process the samples. Static Scan is comprised of pre-filtering, full antivirus scan, cloud query and Static AI scan. Without the Dynamic Scan, the detection rate is expected to be lower. This mode can be considered when throughput is more important than detection precision. Otherwise, consider the regular operating mode to ensure the highest available detection precision.

When deploying FortiSandbox VM00 for Static Scan only, use firmware version 4.2.2 or later. You can leave the clone number at zero. For this deployment, the *Sandbox Threat Intelligence* plus *FortiCare Premium* subscriptions are required. Windows expansion licenses are not required.

Deploying for OT Industry

The OT Malware scans for presence of OT related applications and networking protocols. The LinuxOT is a Linux VM to simulate the OT industry deployment. The VM supports the Siemens application and simulates:

- Modbus
- SNMP
- IPMI
- FTP
- TFTP protocols

The Sandbox Threat Intelligence subscription already includes the Industrial Security subscription which allows you to enable the simulation. To scan files, submit them through any Windows VM. If it is an OT Malware, the LinuxOT will capture that lateral movement behavior and access to those application and protocols.

For information, see [OT Simulation on page 128](#).



Appendix B- Job Details page reference

When you click any job, a *View Job Details* icon will appear. When you click the icon, a new browser tab opens showing detailed forensic information for the job. The information is displayed in three tabs: *Overview*, *Behavior* and *Threat Intelligence*.

The *Job Detail* page header shows the virus name and file type. The icons at the right-side of the page allow you to connect to *FortiGuard Encyclopedia Analysis*, *Mark the job*, *Virus Total*, *Export job detail page to PDF* and *Download Original File*.

Item	Description
Rating	Rating verdict.
File type	File type, for example, <i>exe</i> .
Virus Name	Name of the virus.
FortiGuard Encyclopedia Analysis	Select to view the FortiGuard Encyclopedia analysis of the file if the file has a <i>Malicious</i> rating. This page provides analysis details, detection information, and recommended actions.
Mark the job	Select to mark the file as clean (false positive) or suspicious (false negative). This field is dependent on the file risk type. Enable <i>Submit feedback to cloud</i> to submit job information to the community cloud. The default value is the same as <i>Scan Profile > Advanced > Contribute detected suspicious files to FortiSandbox Community Cloud</i> . You can choose to submit the file for analysis only, without marking it as clean or suspicious. After a file's verdict is overridden: <ul style="list-style-type: none">• Its future rating will be the overridden verdict until you reset it.• The job will be listed in the <i>Scan Job > Overridden Verdicts</i> page for easy tracking. The submission is sent to Community Cloud for review. The Community Cloud team will analyze the job and contact you if necessary using the Contact Email. Please note the Contact Email will not automatically receive emails from FortiSandbox.
Virus Total	Click the <i>Virus Total</i> link to open https://www.virustotal.com in a new page. Only a limited number of queries per minute is allowed with the Virus Total website.
Export Job Details to Page	Export the job details to a PDF report.
Download Original File	Download the password protected original file (zip format) to your management computer for further analysis. The default password for this file is <i>fortisandbox</i> .



Item	Description
	 <p>Always unzip the original file only on a management computer in an analysis environment.</p>
	<p>In a cluster environment, only the primary node has the authority to mark a job as false positive or false negative and to download the original file.</p>

Overview tab

The *Overview* tab is divided into two sections: *Basic Information* and *Analysis over time*.

- *Basic Information* includes the file name, file type, input source etc, and job settings which record the scan conditions such as VM scan timeout, tracing and the rating engine version.
- *Analysis over time* is organized by scan sequence. It shows the start time, followed by static analysis and dynamic analysis if either of them are involved, then shows the final rating as well as the end time.

If an IOC subscription is ordered, a *Summary* will be displayed. This summary provides a brief overview of the findings and checks conducted by FortiSandbox, along with additional recommendations. Please be aware it may take a few moments for the *Summary* content to display after the Job Detail is opened.

	<p>In a cluster environment, each scan node must have its own IOC subscription (purchased separately). When a job is opened on the primary node, it will verify whether the scan unit has the subscription. If the subscription is not present, the summary will not be displayed.</p>
---	--

Basic Information

The *Basic Information* section shows the following information:

Job ID	The ID that identifies the job.
Filename	The filename of the scanned file job
Submit Type	The input source of the file such as on demand, FortiMail etc.
Received	The date and time the job was received by FortiSandbox.
Status	The status of the scan. Status: Done, Canceled, Skipped, and Timed Out.
Scan Unit	The FortiSandbox unit which scanned the job.

Submitted Filename	The submitted filename, for example, the submitted archive file name.
File Type	The file type of the file job.
File Size	The size of the file job.
Submitted By	The user who submitted the scan.
URL	The address of the scanned URL job
Original URL	The original submitted address could be the hierarchy of file job if it is inside archive file.
CDR Applied	If a file is sent via API or ICAP and has been disarmed, this field will appear and display <i>YES</i> .
Password Protected	For PDF and Office files only, shows whether the file is password protected and successfully extracted or not
URL and Payloads	For Submitted URL that has payloads, this field displays a color-coded rating for URL and its payloads.
Archive Files	For archive files and its children, this field displays a color-coded rating for the parent archive file and each child, so that you can quickly identify different ratings for each child. <hr/>  For performance reasons, if the archive file contains too many children, only the first 100 jobs will be displayed in this drop-down list, but user can see all children files from file job page. <hr/>
Original Job	Click the link to view the original job if this is an AV rescan or On-Demand rescan job.
Job settings	
Specified File Names/Pattern	This field appears when the <i>Only scan the following files inside</i> and <i>Specified names or patterns</i> options are configured in the <i>File On-Demand</i> advanced settings.
Scan Bypass	When available, the scan bypass configuration will be displayed.
Specified Browsers	The VM name along with its browser setting.
Pipeline mode OS	The VM launched in pipeline mode.
VM Interaction	When Interaction mode is enabled before jobs are submitted, VM Interaction displays <i>ON</i> . When Interaction is disabled, VM Interaction is not displayed in the <i>Overview</i> page.
Video Record	When <i>Record Video</i> is enabled, <i>Video Record</i> displays <i>ON</i> . When <i>Record Video</i> is disabled, <i>Video Record</i> is not displayed.
Real-time Zero-Day Anti-Phishing Prefilter Version	Real-time Zero-Day Anti-Phishing Prefilter Version if Real-time Zero-Day Anti-Phishing was used.

AI Engine and Model	AI Engine and Model version if this AI technique is applied for the job.
Tracer Package Version	Tracer Package Version used for the job.
Rating Package Version	Rating Package Version used for the job.

Analysis over time

Analysis over time shows the information of analysis during scan flow:

Item	Description
Scan Start Time	The date and time the scan started and the time zone.
Static Analysis	
Digital Signature	The digital signature availability status of the scanned file.
URL Category	The URL category if URL detected.
Embedded URL	The number of URLs in the sample file.
Indicators	The key indicator of job behavior with severity (<i>High, Medium, Low and Info</i>), description and attack technique.
Dynamic Analysis	
VM Start Time	The start time of VM if VM scan is involved.
VM up Time	The time VM scan used.
VM End Time	The time when VM scan finished.
Launched OS	The VM that was launched to scan the job.
Infected OS	The infected OS that was scanned.
Launched Browsers	The VM and its launched browser if involved in the scan.
Anti Evasion Triggers	The VM that triggered by Anti Evasion.
Indicators	The key indicator of the job behavior with severity (<i>High, Medium, Low and Info</i>), description and attack technique .
Rating	
Rating	The rating is the final verdict of the FortiSandbox on the scan job based on the collected behavioral activities and static analysis. The assessment of their risk and impact is based on our FortiGuard Threat Intelligence of previously-known malware. Ratings include <i>Malware, High risk, Medium risk, Low risk, Clean</i> and <i>Unknown</i> .
Rated By	The source of the rating decision. The following are the sources by scan module:

Item	Description						
	<table border="1"> <thead> <tr> <th>Scan module</th> <th>Sources</th> </tr> </thead> <tbody> <tr> <td>Static Scan related</td> <td>AV Scan Engine, Sandbox Community Cloud, Static Scan Engine, Yara Scan Engine, Dynamic Scan Cache, Allowlist/Blocklist, FortiGuard Allowlist/Blocklist, Overriden Verdicts and Fabric Device (FortiNDR).</td> </tr> <tr> <td>Dynamic Scan related</td> <td>Dynamic Scan, Dynamic Scan (MacOS Cloud), Dynamic Scan (Cloud), Customized Rating and Real-time Zero-Day Anti-Phishing Service.</td> </tr> </tbody> </table> <p>The module names have been changed since v4.2.0. If you require the previous module names for mapping, please contact Customer Support.</p>	Scan module	Sources	Static Scan related	AV Scan Engine, Sandbox Community Cloud, Static Scan Engine, Yara Scan Engine, Dynamic Scan Cache, Allowlist/Blocklist, FortiGuard Allowlist/Blocklist, Overriden Verdicts and Fabric Device (FortiNDR).	Dynamic Scan related	Dynamic Scan, Dynamic Scan (MacOS Cloud), Dynamic Scan (Cloud), Customized Rating and Real-time Zero-Day Anti-Phishing Service.
Scan module	Sources						
Static Scan related	AV Scan Engine, Sandbox Community Cloud, Static Scan Engine, Yara Scan Engine, Dynamic Scan Cache, Allowlist/Blocklist, FortiGuard Allowlist/Blocklist, Overriden Verdicts and Fabric Device (FortiNDR).						
Dynamic Scan related	Dynamic Scan, Dynamic Scan (MacOS Cloud), Dynamic Scan (Cloud), Customized Rating and Real-time Zero-Day Anti-Phishing Service.						
Total Scan Time	The total scan time spent.						
Real-Time Zero-Day Anti-Phishing Verdict	<p>If the sample is a URL and scanned by the Real-time Zero-Day Anti-Phishing Server, the Real-time Zero-Day Anti-Phishing Verdict will be shown and Phishing URL Target will also be displayed on the Job Details page.</p> <p>A download button and a question mark will appear after the Real-time Zero-Day Anti-Phishing Verdict when there is a screenshot available to download and more detailed information from the Real-time Zero-Day Anti-Phishing server is returned.</p>						
End							
Scan End Time	The time when entire scan finished						

Behavior tab

The *Behavior* tab shows information for the Static scan and VM scan results. Select the VM or static scan from the dropdown at the top-left of the page to view a detailed analysis of the scan.



This page may not be displayed if there is no information from either the Static scan or the VM scan.

Details

The *Details* section shows:

Tab	Item	Description
VM scan results	Behavior Info	<p>View the file's behavior over time and its density during its execution.</p> <ul style="list-style-type: none"> • Clean behaviors: green bubble. • Suspicious behaviors: red, blue, or orange bubble. • The higher the bubble, the more serious the event is. • To view the event details, hover your mouse over the bubble. <p>If a file scan is scanned with more than one VM type, the VM tab will dynamically switch to the chart for that type.</p> <p>If the file hits any imported YARA rule, a YARA tab will appear with detailed information. including:</p> <ul style="list-style-type: none"> • The hit rule • Rule's risk level • Rule set name • Link to original YARA rule file
	Indicators	<p>A summary of behavior indicators, if available.</p> <p>When detailed information is available, a corresponding icon is displayed. Clicking the icon will link to the specific operation details. For some operations, such as File Operations, you can download files in a password protected ZIP format.</p>
	Files Operations	<p>The file-related operations, includes <i>Created/Deleted/Renamed/Modified/Set Attributes</i>. For some file operations, you can download files in a password protected ZIP format.</p>
	Registry Operations	<p>The registry-related operations, includes <i>Created/Deleted</i>.</p>
	Memory Operations	<p>The memory-related operations, includes <i>Written, Process created and Injected, Process Created, Process Related</i>.</p>
	Network Operations	<p>When any network operations are detected during a VM scan, the target URL/IP addresses, along with their category and rating, will be displayed.</p>
	Embedded URLs	<p>For PDFs, Office and HTML files, if the file contains embedded URLs or QR code, a maximum of three URLs and three QR codes can be scanned inside VM and listed here.</p> <p>For more information on how to enable sandboxing embedded URL/QR code, see the FortiSandbox CLI Reference Guide.</p>

Tab	Item	Description
	PCAP Information	The packet data captured.
	Botnet Info	The botnet name and target IP address.
	Traffic Signature	Displays the signatures of industrial application network traffic that are detected. Click the name to go to its FortiGuard page.
	IPS Signature	Displays IPS signatures that are detected, the signatures are displayed. Click the name to go to its FortiGuard page.
	Behaviors In Sequence	The executable file's behavior during execution, in time sequence.
Static Scan	Behavior Info	If the file triggers any suspicious results during the static scan process, detailed information will be provided.
	Indicators	A summary of behavior indicators, if available. When detailed information is available, a corresponding icon is displayed. Clicking the icon will link to the specific operation details.
	Network Operations	When any network operations are detected during a Static scan, the target URL/IP addresses, along with their category, will be displayed.
	Embedded URLs	Displays all embedded URLs and their categories present in the sample when the static scan of embedded URLs is enabled. To view the configuration details, use the CLI command: <code>sandboxing-embeddedurl</code> .

Tree View

The *Tree View* section will show a tree for the file's static structure or file's parent-child process relationship when it executes inside a guest VM. You can drag the tree with your mouse and zoom in or out using the mouse wheel. If there is suspicious activity with one tree node, its label will be colored red. Clicking a node in the tree will open more information in tab format. Suspicious information is shown in red, so you can quickly locate it.

When selecting any operation in the *Details* section, you can click *View it on Tree*, then the specific operation will be shown in Tree View with a highlighted red color to indicate its location. However, you cannot jump from the *Tree View* section directly to *Detail* section.



By default, *Analysis over time* and *Tree View* only show relative important indicators and icons. To show all detail debugging information, please enable in job details page *Show debugging process in System* > [Settings](#).

Screenshots

The *Screenshots* section will display thumbnail of screenshots if there are any. To enlarge the image, hover over the thumbnail.

Download

The *Download* section contains buttons for download options.

Index	Description
Captured Packets	Select the <i>Captured Packets</i> button to download the tracer PCAP file to your management computer. The packet capture (PCAP) file contains network traffic initiated by the file. You must have a network protocol analyzer installed on your management computer to view this file. The <i>Captured Packets</i> button is not available for all file types.
Tracer Package	Download the compressed .zip file containing the tracer log and related files. The password protected /backup folder in the tracer log contains information about the program’s execution. The default password for this file is fortisandbox. When downloading the tracer package for an executable file within an archive, the downloaded package will include the parent archive file.
Tracer Log	A text file containing detailed information collected inside the Sandbox VM.
STIX IOC	Download the IOC in STIX2 format.
Screenshot	Download screenshot images when the file was running in the sandbox. This image is not always available.
Video Download Link	Download the video when the <i>Record Video</i> is enabled.



The downloaded Tracer Package and Screenshot contain sensitive data and are saved in a password protected zip file. The password for accessing these files is fortisandbox. Other downloaded packages do not require a password for access. Please always unzip the protected download packages only on a management computer in an analysis environment.

Threat Intelligence tab

The *Threat Intelligence* tab shows *Key Highlights*, *Threat Enrichment via FortiGuard IOC*, *Threat IOC Table* and *ATT&CK Matrix*.



- The *Key Highlights* and *Threat Enrichment via FortiGuard IOC* sections are only available when and IOC subscription is active in the scan unit.
-

Key Highlights

This section summarizes key findings from the FortiSandbox analysis, along with explanations and recommendations.

Threat Enrichment via FortiGuard IOC

This indicator displays the FortiGuard live rating and its associated confidence level. The indicator will display *No valid IOC subscription* if the standalone FortiSandbox or worker unit performing the scan does not have a valid IOC subscription.

Threat IOC Table

This table lists all identified threats, including MD5 hashes or URLs detected during the analysis.

ATT&CK Matrix

The *ATT&CK Matrix* presents a combination of MITRE attack techniques if multiple MITRE tactics were detected across different VMs. It displays the malware's techniques and tactics based on MITRE ATT&CK Version 11. A simplified version with relevant information is shown. Clicking on any detection opens a pop-up window with the technique code, description, and rating. For more details on specific techniques, you can click the technique code to visit the MITRE website at MITRE Mapping.

Appendix C - Malware types

The following table lists malware types and attacks that are identified by FortiSandbox.

Malware type	Description
Adware	Adware malware is a software package which attempts to access advertising websites. Adware displays these unwanted advertisements to the user.
Backdoor	Backdoor malware installs a network service for remote access to your network. This type of malware can be used to access your network and install additional malware, including stealer and downloader malware.
Botnet	Botnet malware is used to distribute malicious software. A botnet is a collection of Internet-connected programs communicating with other similar programs in order to perform a task. Computers that are infected by botnet malware can be controlled remotely. This type of malware is designed for financial gain or to launch attacks on websites or networks.
Downloader	Downloader malware attempts to download other malicious programs.
Dropper	Dropper malware is designed to install malicious software to the target system. The malware code may be contained within the dropper or downloaded to the target system once activated.
Exploit	Exploit malware takes advantage of a bug, glitch, or vulnerability in order to cause unintended or unanticipated behavior to occur on computer software. This behavior often includes such things as gaining control over a computer system, allowing privilege escalation, or a denial-of-service (DoS) attack.
Grayware	Grayware malware is a classification for applications that behave in a manner that is annoying or undesirable. Grayware includes spyware, adware, dialers, and remote access tools that are designed to harm the performance of computers on your network.
Hijack	Hijack malware attempts to hijack the system by modifying important registry keys or system files.
Infector	Infector malware is used to steal system and user information. The stolen information is then uploaded to command and control servers. Once the infector installs on a computer, it attempts to infect other executable files with malicious code.
Injector	Injector malware injects malicious code into system processes to perform tasks on its behalf.
Riskware	Riskware malware has security-critical functions which pose a threat to the computer.
Rootkit	Rootkit malware attempts to hide its components by replacing vital system executables. Rootkits allow malware to bypass antivirus detection as they appear to be necessary system files.

Malware type	Description
Stealer	Stealer malware is used to harvest login credentials of standalone systems, networks, FTP, email, game servers and other websites. Once the system is infected, the malware can be customized by the attacker.
Trojan	Trojan malware is a hacking program which gains privileged access to the operating system to drop a malicious payload, including backdoor malware. Trojans can be used to cause data damage, system damage, data theft or other malicious acts.
Unknown	No definitions currently exist for this type of attack.
Worm	Worm malware replicates itself in order to spread to other computers. This type of malware does not need to attach itself to an existing program. Worms, like viruses, can damage data or software.

FortiSandbox scans executable (Windows .exe and .d11 script files), JavaScript, Microsoft Office, Adobe Flash, PDF, archives, and other file types the user defines. JavaScript and PDF are the two common software types that malware uses to execute malicious code. For example, JavaScript is often used to create heap sprays and inject malicious code to execute in other software products such as Adobe Reader (PDF).

When a malware is scanned inside a FortiSandbox VM environment, FortiSandbox scans its outgoing traffic for connections to botnet servers and determines the nature of the traffic and connection hosts.

Appendix D - Maximum values

This topic provides the minimum and maximum values for configurations, file size limits, and concurrent client device connections.

- [Configuration limits on page 255](#)
- [File size limits on page 257](#)
- [Client Device Connections](#)

Configuration limits

Job inputs	Min value	Max value	Default value	Configurable
Filename length	1	4096 characters		
Directly URL length	1	3 KB characters		
On Demand job comments lengths	0	255 characters		
Number of children files to unpack from archive file	1	2000000	1000 (VM appliance)	Y
		2000000	10,000 (hardware appliance)	Y
File size to enter VM		512 MB		
File size to upload to FortiSandbox Community Cloud		200MB		
Archive file unpack timeout	1	3600	15s (regular file < 512 MB)	Y
	1	86400	600s (large file >512M)	Y
YARA scan timeout	1	3600	30s (regular file <=512M)	Y
		3600	60s (big file >512M)	Y

Archive file that will be scanned with executable file in VM	0	100	5	Y
Allow/Block list	Min value	Max value	Default value	Configurable
URL length	1	2048 characters		
Domain name length	1	253 characters		
URL Regex	1	1024 characters		
MD5+SHA1+SHA256 record limit in list	0	50,000		
URL Regex records	0	1,000		
Domain + URL records	0	50,000		
Custom VM				
VM meta file for Installed Applications	0	50 lines		
IOC Package	Min value	Max value	Default value	Configurable
Malware package entries counts	0	100,000		
URL package entries counts	0	1000		
TCP RST package entries counts	0	100,000		
Scan Profile	Min value	Max value	Default value	Configurable
URL scan depth	0	5	0	Y
URL count to be extracted from email body	0	10	0	Y
VM Scan timeout for executable file	60s	180s	180s	Y
VM Scan timeout for non-executable file	45s (hardware unit)	180s	60s	Y
	60s (virtual unit)	180s	60s	Y

VM Scan timeout for URL	30s	1200s	60s	Y
Default Password list length for Password-protected Archive files	0	30	0	Y
Default Password list length for Password-protected PDF/Office files	0	30	0	Y
System Login	Min value	Max value	Default value	Configurable
LDAP/Radius remote authentication	10s	180s	10s	Y
Radius PAP secret		52 characters		
SAML Attribute		128		
GUI idle time	1 min	480m	30m (Azure 3m)	Y
User management	Min value	Max value	Default value	Configurable
Username length	1	64 characters		
User password	6 characters	64 characters		
Security Fabric	Min value	Max value	Default value	Configurable
Network Share Entry	0	512		
Quarantine Entry	0	512		
ICAP Profile Entry	1	32		

File size limits

File size limits are determined by the input type (on-demand, sniffer etc). The default limit for each type is set to 200MB for single file and 500MB for uncompressed archives. You can view or change the file-size limit using the CLI.

Hardware	Device	Adapter	Netshare	Sniffer	ICAP	JsonRPC	On-Demand
Single File (MB)	512	1024	10240	1024	1024	30720	30720

Uncompressed Archive (MB)	2048	2048	10240	2048	2048	30720	30720
Virtual (VM00)	Device	Adapter	Netshare	Sniffer	ICAP	JsonRPC	On-Demand
Single File (MB)	512	1024	10240	1024	1024	30720	30720
Uncompressed Archive (MB)	2048	2048	10240	2048	2048	30720	30720
FortiSandbox Cloud (PaaS)	Device						On-Demand
Single File (MB)	512						1024
Uncompressed Archive (MB)	2048						2048
FortiGate Cloud Sandbox (SaaS)	Device						
Single File (MB)	200						
Uncompressed Archive (MB)	500						

To view or change the file size limit with the CLI:

```
filesize-limit
```

For more information, see the [FortiSandbox CLI Reference Guide](#) in the Fortinet Documents Library.

Client device connections

A FortiSandbox system has a maximum authorized limit of 50,000 FortiClient endpoints and 10,000 other Fortinet devices. If the device is a FortiGate, each VDOM that sends files to FortiSandbox is counted as one device.

Each client device can have multiple concurrent connections to FortiSandbox at one time. These connections are used for file transfers and result queries. The maximum number of concurrent connections is 20,000 for FSA 3000E, 3000F and 3000G models, and 10,000 for all other models. When this limit is exceeded, new connections will be rejected, and an event log will be generated.

Full capacity will depend on the model and its system capacity.

Appendix E - Job risk rating

A job is created for each scanned file and URL. A job is determined to be either *clean* or *suspicious* based on a score. A suspicious job is assigned one of the risk ratings where its score is comprised of a collection of attributes (static) or behavioral (dynamic). Understanding each risk rating and recommendation is important when choosing the proper security policies to balance the effectiveness and operational needs.

Rating	Description	Recommendation
High Risk	<p>A job is assigned a <i>High Risk</i> level when there is an immediate and substantial threat of harmful actions or features.</p> <p>These file jobs pose a significant threat to the system security and integrity, potentially leading to major data breaches or system failures.</p> <p>These URL jobs have strong evidence of being a malware, phishing or command-and-control site.</p>	<p>The organization's SOC team should take swift and decisive action to protect the system and data. Immediately move the file(s) to a secure, isolated location. If the file is associated with a network or external device, disconnect it to prevent further damage. Check the file's dynamic scan behavior if it is available to look for signs of unauthorized access, data exfiltration, or suspicious activities.</p> <p>On files and URLs, a block action in the security policy is highly recommended to mitigate the risks posed by high-risk files.</p>
Medium Risk	<p>A job is assigned a <i>Medium Risk</i> level when there is a reasonable likelihood of it carrying or initiating malicious activity.</p> <p>The potential damage posed by such file jobs are considered moderate. It may cause some disruptions or minor system compromises, but not to a severe degree.</p> <p>These URL jobs have evidence of being associated with a malware, phishing or command-and-control site whether recently or in the past.</p>	<p>The organization's SOC team should evaluate the file seriously, including understanding the specific context in which it will be used, the system it will run on, the data it will access, and its potential impact on system integrity and data security.</p> <p>On files, a block action in the security policy is typically recommended to prevent its download, especially when the job is potentially used in attack campaigns (e.g., executable files, files with URLs inside, .scr files or archive files).</p> <p>On URLs, a block action in the security policy is recommended to avoid visiting or downloading contents from these URLs.</p>
Low Risk	<p>A job is assigned a <i>Low Risk</i> level when only a minimal number of anomalies and indicators are detected in the job's attribute or behavior.</p>	<p>The organization's SOC team should evaluate the context in which the file will be used, the system it will run on and the data it will access.</p>

Rating	Description	Recommendation
	<p>This implies that while the file or URL job is not entirely typical, any potential threat it might pose to the system integrity or data security is negligible.</p>	<p>On files, we recommend a review of the indicators to determine whether the minimal anomalies detected pose any significant risk. If the impact is negligible, use caution when proceeding with the file.</p> <p>On URLs, caution and tighter security is preferred. Temporarily blocking these URLs and allowing the SOC team to review and take actions accordingly is recommended. However, this may incur operational overhead.</p>

Appendix F: FortiSandbox PaaS supported features

The following table compares the available features in FortiSandbox with those available in FortiSandbox PaaS.

Feature	Supported	Unsupported
Dashboard	Status, Scan Performance, Incident Assist, System Information, Connectivity and Services widget, Scan Statistics, Top Critical Logs, Threats Distribution, File Quick Download widget, and Runtime Usage.	Sniffer Traffic widget
Security Fabric	FortiSandbox PaaS can integrate with FortiGate, FortiMail, FortiWeb, FortiClient EMS, and FortiClient devices to receive files for analysis and return verdicts. This includes functionalities such as configuring device authorization, submission limitations, and receiving email notifications and PDF reports. FortiNDR integration (for generating verdicts based on FortiNDR ratings and influencing scan flow)	Adapter, Network Share, Quarantine, and Sniffer.
Scan Job	Job Queue, File Job, URL Job, Overridden Verdicts, File On-Demand, and URL On-Demand	VM Jobs
Scan Policy & Object	Scan Profile Scan Profile Advanced Tab (includes: Cloud Rating Service, Real-Time Zero-Day Anti-Phishing Service, URL depth limit, URL count to be extracted from email body, URL content limit, VM Scan timeouts for various file and URL types, Default Password-protected archive/PDF/Office files lists, Reject duplicate files from Security Fabric Device, and Upload detection statistics to FortiGuard.)	Scan Profile > Advanced: Adaptive Scan, Parallel VM Scan, Pipeline Mode, Contribute detected suspicious URL to FortiGuard VM Settings: Tools, View VM usage, Delete VM, Create a Custom VM from this VM, Browser options, Local clone status. Job Archive, TCP RST Package, Global Network

Feature	Supported	Unsupported
	<p>VM Settings (Universal VM management, setting clone numbers for VM images, downloading Default and Optional VMs from FortiGuard, and managing Remote (Cloud) VMs like MACOSX and WindowsCloudVM).</p> <p>Job Priority, Allowlist and blocklist, Web Category, Customized Rating, YARA Rules, Malware Package, URL Package and Threat Intelligence</p>	
System	<p>Mail Server: FortiSandbox Cloud (PaaS) supports sending notification and alert emails via Fortinet's mail server. By default, the built-in server is set to fortinet.com. Additionally, the option to specify your custom mail server remains available as before.</p> <p>To configure Alert Notifications and Scheduled Reports, refer to the Mail Servers topic in the FortiSandbox Administration Guide.</p> <p>FortiGuard, Certificates, System Recovery, Event Calendar and Event Calendar Settings, Settings, and Job View Settings</p>	<p>Admin Profiles: Create, Delete, Limited Access, Security Fabric(Adapter, Network Share, Quarantine, Sniffer), Scan Job (Allow On-Demand Scan Interaction, Allow On-Demand Scan Video Recording), System (Prioritize Netshare Scan), HA Cluster Logs & Reports (Network Alerts) Settings > VM External Network Access HA Cluster</p>
Log & Report	<p>Log Details, Logging Levels, Raw Logs, Log Categories, Viewing Logs in FortiAnalyzer/FortiAnalyzer Cloud/Remote Syslog Server, Summary Reports, Report Center, and Customize Report</p>	<p>Network Alerts</p>

Appendix G: FortiSandbox Lite Mode

You can switch FortiSandbox from Full to Lite mode to simplify GUI configuration. In Lite mode, some configuration features are streamlined, and VM Dynamic Scan is not supported.

Lite Mode streamlines the following features:

Feature/Category	Feature by Web Page	Notes
Dashboard	Status	<i>Sniffer Traffic</i> widget is not available
	Scan Performance	The Following widgets are not available: <ul style="list-style-type: none"> VM Scan Count per Hour Average VM Wait Time per Hour Average VM Scan Time per Hour
Security Fabric	Adapter, FortiNDR, Quarantine, Sniffer	Feature pages are not available
Scan Job	VM Jobs, File On-Demand, URL On-Demand	Feature pages are not available
	Scan Profile > Pre-Filter	The following options are not available: <ul style="list-style-type: none"> Check for Active Content on the selected file types during VM Scan pre-filter Use the results of the following during VM Scan pre-filter
	Scan Profile > VM Association	Page is not available
	Scan Profile > Advanced	The following options are not available: <ul style="list-style-type: none"> Scan Enhancements Adaptive Scan Parallel VM Scan Pipeline Mode Cloud Services Cloud Rating Service Limits and Timeouts
	VM Settings, Job Archive, Web Category, Customized Rating, TCP RST Package, Threat Intelligence, Global Network	Pages are not available
System	FortiGuard	The following options are not available: <ul style="list-style-type: none"> VM Image Download Proxy Settings FortiSandbox Community Cloud & Threat Intelligence Settings FortiSandbox WindowsCloudVM

Feature/Category	Feature by Web Page	Notes
		Settings
	Event Calendar, Event Calendar Settings	Pages are not available
Log & Report	VM Events, Network Alerts	Pages are not available

The following CLI commands are not supported when Lite Mode is enabled:

Category	Feature by CLI Command	Notes
VM Settings	vm-status	Display the status for virtual hosts
	vm-reset	Reset the virtual hosts and reboot
	confirm-id	Set confirm ID for windows or office activation
	vm-customized	Install customized VM
Scan Policy	reset-scan-profile	Reset clone # and file extension association to firmware default
	sandboxing-prefilter	Enable/disable sandboxing prefilter for file types
	sandboxing-embeddedurl	Enable/disable sandboxing embedded urls in PDF or OFFICE documents.
	sandboxing-ratio	Set the ratio for jobs to be scanned in sandboxing.
	sandboxing-adaptive	Enable/disable adaptive clone for sandboxing.
	sandboxing-parallel	Enable/disable parallel sandboxing scan.
	sandboxing-rse	Enable/disable sandbox Cloud Rating.
	sandboxing-pebox	Enable/disable pebox service.
	sandboxing-pipeline	Enable/disable sandboxing pipeline mode



www.fortinet.com

Copyright© 2026 Fortinet, Inc. All rights reserved. Fortinet®, FortiGate®, FortiCare® and FortiGuard®, and certain other marks are registered trademarks of Fortinet, Inc., and other Fortinet names herein may also be registered and/or common law trademarks of Fortinet. All other product or company names may be trademarks of their respective owners. Performance and other metrics contained herein were attained in internal lab tests under ideal conditions, and actual performance and other results may vary. Network variables, different network environments and other conditions may affect performance results. Nothing herein represents any binding commitment by Fortinet, and Fortinet disclaims all warranties, whether express or implied, except to the extent Fortinet enters a binding written contract, signed by Fortinet's Chief Legal Officer, with a purchaser that expressly warrants that the identified product will perform according to certain expressly-identified performance metrics and, in such event, only the specific performance metrics expressly identified in such binding written contract shall be binding on Fortinet. For absolute clarity, any such warranty will be limited to performance in the same ideal conditions as in Fortinet's internal lab tests. Fortinet disclaims in full any covenants, representations, and guarantees pursuant hereto, whether express or implied. Fortinet reserves the right to change, modify, transfer, or otherwise revise this publication without notice, and the most current version of the publication shall be applicable.