

3500G Hardware Configuration Guide

FortiSIEM 6.3.3

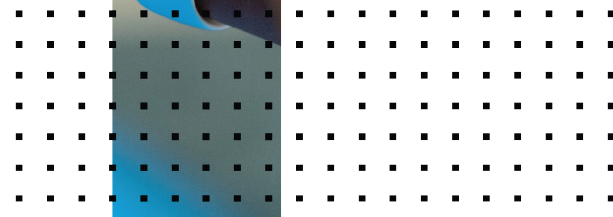
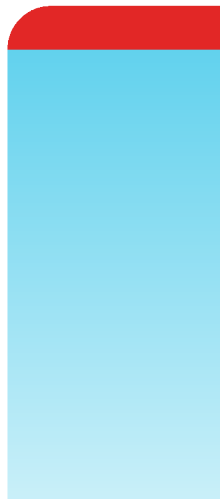

FORTINET DOCUMENT LIBRARY

<https://docs.fortinet.com>

FORTINET VIDEO LIBRARY

<https://video.fortinet.com>

FORTINET BLOG

<https://blog.fortinet.com>

CUSTOMER SERVICE & SUPPORT

<https://support.fortinet.com>

FORTINET TRAINING & CERTIFICATION PROGRAM

<https://www.fortinet.com/training-certification>

FORTINET TRAINING INSTITUTE

<https://training.fortinet.com>

FORTIGUARD LABS

<https://www.fortiguard.com>

END USER LICENSE AGREEMENT

<https://www.fortinet.com/doc/legal/EULA.pdf>

FEEDBACK

Email: techdoc@fortinet.com



01/04/2024

FortiSIEM 6.3.3 3500G Hardware Configuration Guide

TABLE OF CONTENTS

Change Log	4
Appliance Setup	5
All-in-one Installation	5
Step 1: Rack mount the FSM-3500G appliance	6
Step 2: Power On the FSM-3500G appliance	6
Step 3: Verify System Information	6
Step 4: Configure FortiSIEM via GUI	7
Step 5: Generate FortiSIEM FSM-3500G License Key file from FortiCare	13
Step 6: Register FortiSIEM License	13
Step 7: Accessing FortiSIEM UI	14
Step 8: Choose an Event Database	14
Cluster Installation	14
Installing the Supervisor	14
Installing Workers	16
Registering Workers	16
Installing Collectors	17
Registering Collectors	17
Factory Reset	21
Step 1: Uninstall FortiSIEM application	21
Step 2: Reinstall FortiSIEM application	21

Change Log

Date	Description
06/02/2021	Initial release of this guide.
06/07/2021	Updated Elasticsearch screenshot.
07/06/2021	Release for 6.3.0.
08/26/2021	Release for 6.3.1.
10/08/2021	Remove Migration section from 6.3.x guides.
10/15/2021	Release for 6.3.2.
11/17/2021	Updated Register Collectors instructions for 6.x guides.
12/22/2021	Release for 6.3.3.
10/20/2022	Updated Register Collectors instructions for 6.x guides.

Appliance Setup

Follow the steps below to setup FSM-3500G appliance.

- [All-in-one Installation](#)
- [Cluster Installation](#)

All-in-one Installation

Follow these steps to install all of the FortiSIEM components at one time.

- [Step 1: Rack mount the FSM-3500G appliance](#)
- [Step 2: Power On the FSM-3500G appliance](#)
- [Step 3: Verify System Information](#)
- [Step 4: Configure FortiSIEM via GUI](#)
- [Step 5: Generate the FortiSIEM FSM-3500G License Key file](#)
- [Step 6: Register the FortiSIEM License](#)
- [Step 7: Accessing FortiSIEM UI](#)
- [Step 8: Choose an Event Database](#)

Step 1: Rack mount the FSM-3500G appliance

1. Follow FortiSIEM 3500G QuickStart Guide [here](#) to mount FSM-3500G into the rack.
2. Insert Hard Disks positions as shown below:

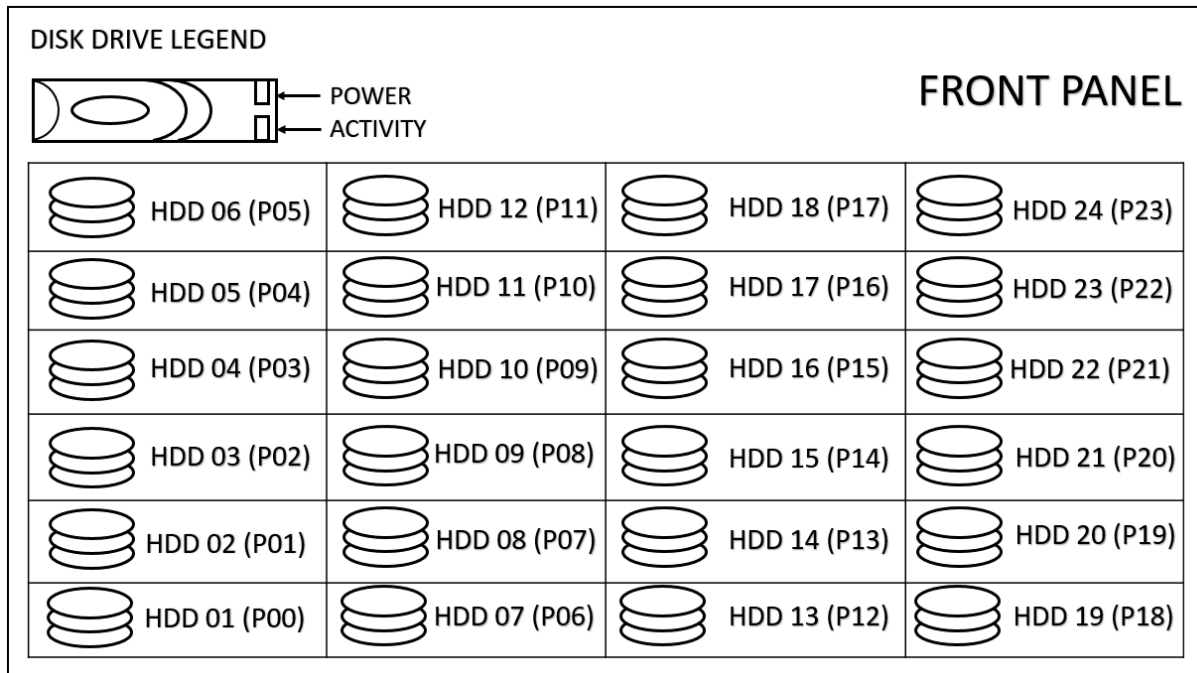

3. Connect FSM-3500G to the network by connecting an Ethernet cable to Port0.



Before proceeding to the next step, connecting Ethernet cable to Port0 is required for Network configuration.

Step 2: Power On the FSM-3500G appliance

1. Make sure the FSM-3500G device is connected to a Power outlet and an Ethernet cable is connected to Port0.
2. Power On the FSM-3500G device.



FSM-3500G appliance does not have a default IP address. To connect to the GUI, an IP address must be configured using the GUI ([Step 4](#)).

Step 3: Verify System Information

1. Connect to the FSM-3500G appliance using VGA port or Console port.
2. Login as 'root' user with password `ProspectHills`. You will be required to change the password. Remember this password for future use. Once you change the password, you will be logged out. Login again with your new password.
3. Run `get` to check the available FortiSIEM commands.

- Use these commands to check the hardware information. After running each command, ensure that there are no errors in the displayed output.

Command	Description
<code>get system status</code>	Displays system name, version and serial number.
<code>diagnose hardware info</code>	Displays system hardware information like CPUs, Memory and RAID information.
<code>diagnose interface detail port0</code>	Displays interface status (see the following table).

The following table describes the port number mapping between the 3500G physical port number label and the FortiSIEM 6.3.3 interface port numbering.

3500G Physical Port Number Label	FSM 6.3.3 Interface Port Numbering
port1	port0
port2	port1
port3	port4
port4	port5
port5	port2
port6	port3

Step 4: Configure FortiSIEM via GUI

Follow these steps to configure FortiSIEM by using a simple GUI.

- Log in as user `root` with the password you set in [Step 3](#) above.
- At the command prompt, go to `/usr/local/bin` and enter `configFSM.sh`, for example:
`configFSM.sh`
- In the console, select **1 Set Timezone** and then press **Next**.

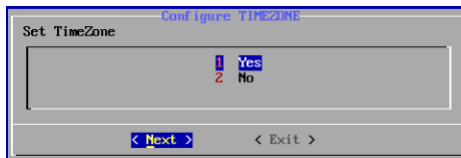

- Select your **Region**, and press **Next**.

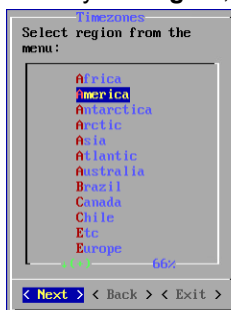

- Select your **Country**, and press **Next**.

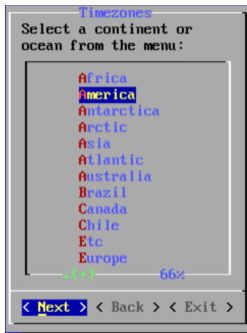

- Select the **Country** and **City** for your timezone, and press **Next**.

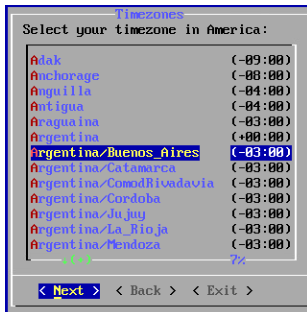

- Select **1 Supervisor**. Press **Next**.

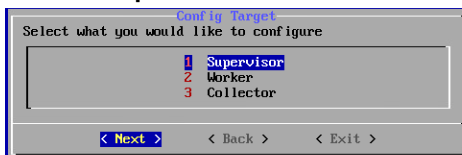

Regardless of whether you select **Supervisor** or **Worker**, you will see the same series of screens.

- If you want to enable FIPS, then choose **2**. Otherwise, choose **1**. You have the option of enabling FIPS (option **3**) or disabling FIPS (option **4**) later.

Note: After Installation, a 5th option to change your network configuration (**5 change_network_config**) is available. This allows you to change your network settings and/or host name.



- Determine whether your network supports IPv4-only, IPv6-only, or both IPv4 and IPv6 (Dual Stack). Choose **1** for IPv4-only, choose **2** for IPv6-only, or choose **3** for both IPv4 and IPv6.

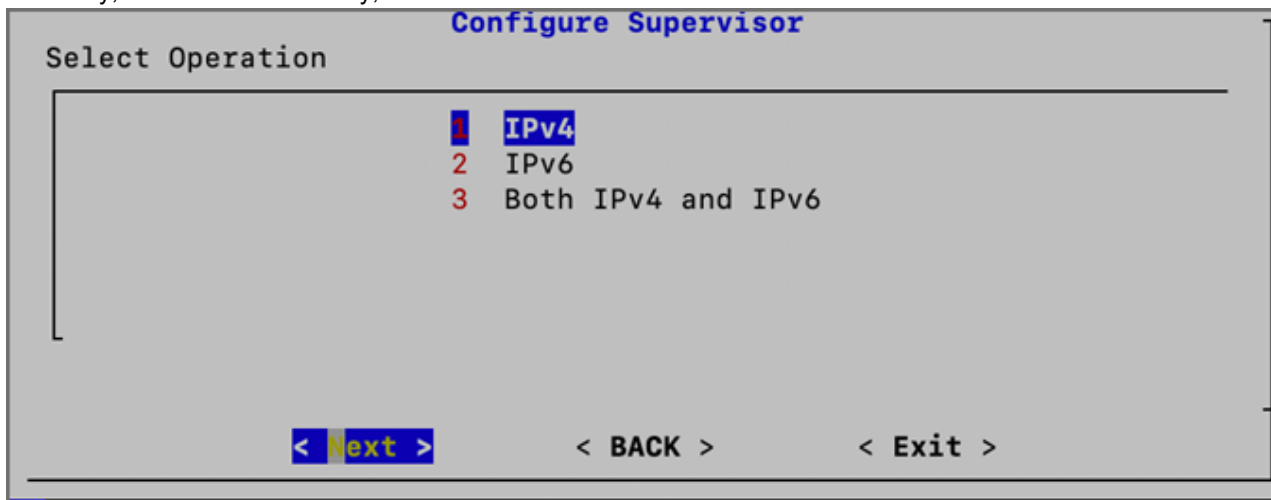

- If you choose **1** (IPv4) or choose **3** (Both IPv4 and IPv6), and press **Next**, then you will move to step 11. If you choose **2** (IPv6), and press **Next**, then skip to step 12.
- Configure the network by entering the following fields. Note the IP Address--you will need it in a later step. Press **Next**.

Option	Description
IPv4 Address	The Supervisor's IPv4 address
NetMask	The Supervisor's subnet
Gateway	Network gateway address
DNS1, DNS2	Addresses of the DNS servers

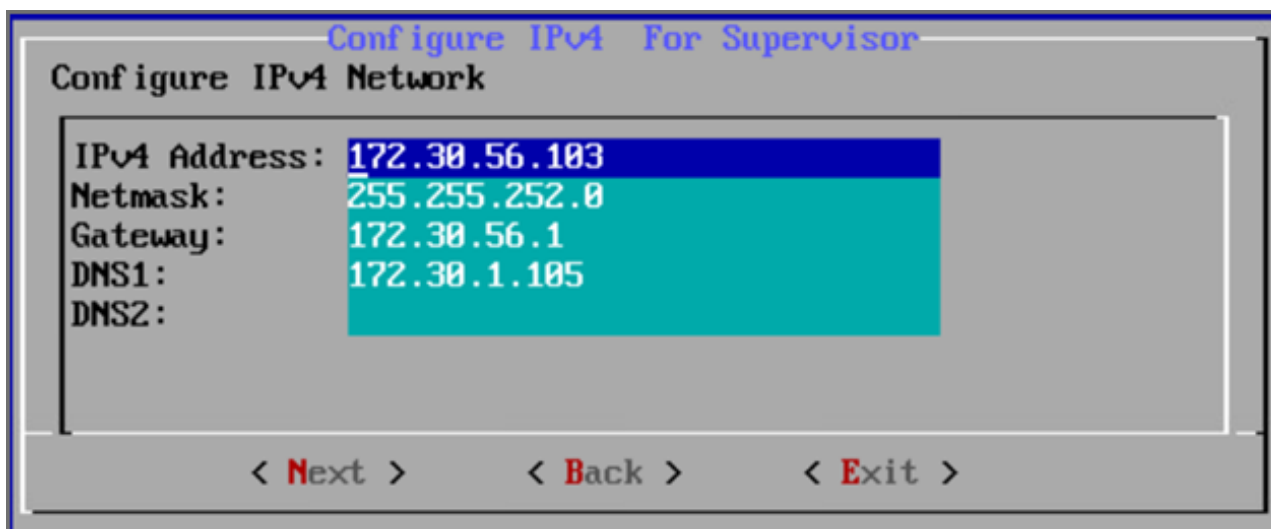

- If you chose **1** in step 9, then you will need to skip to step 13. If you chose **2** or **3** in step 9, then you will configure the IPv6 network by entering the following fields, then press **Next**.

Option	Description
IPv6 Address	The Supervisor's IPv6 address
prefix (Netmask)	The Supervisor's IPv6 prefix
Gateway ipv6	IPv6 Network gateway address
DNS1 IPv6, DNS2 IPv6	Addresses of the IPv6 DNS server 1 and DNS server2

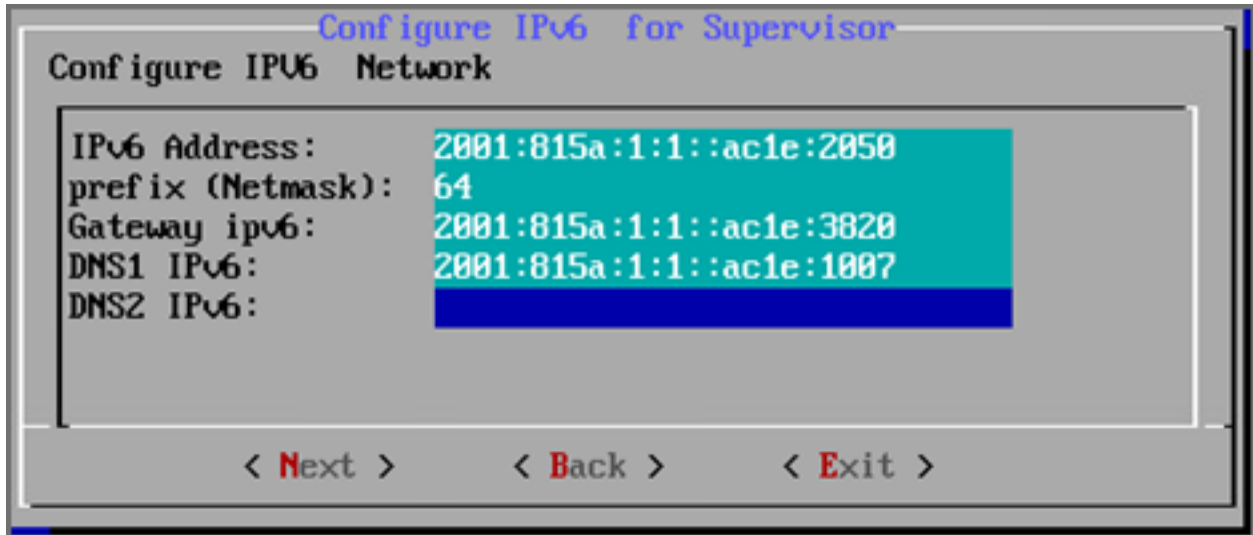

Note: If you chose option 3 in step 9 for both IPv4 and IPv6, then even if you configure 2 DNS servers for IPv4 and IPv6, the system will only use the first DNS server from IPv4 and the first DNS server from the IPv6 configuration.

Note: In many dual stack networks, IPv4 DNS server(s) can resolve names to both IPv4 and IPv6. In such environments, if you do not have an IPv6 DNS server, then you can use public IPv6 DNS servers or use IPv4-mapped IPv6 address.

13. Configure Hostname for Supervisor. Press **Next**.

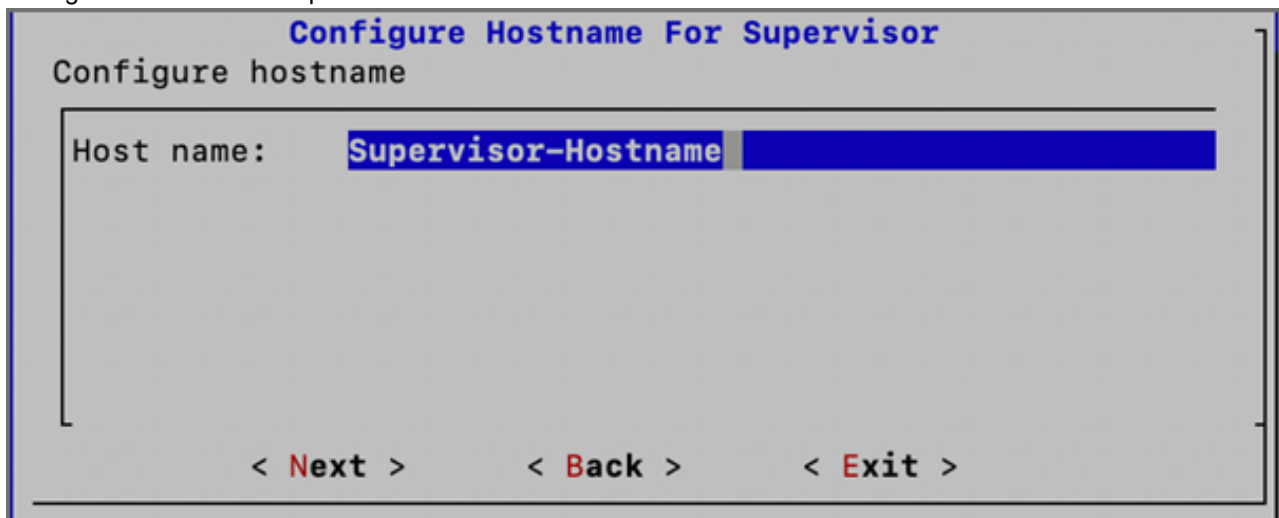

Note: FQDN is no longer needed.

14. Test network connectivity by entering a host name that can be resolved by your DNS Server (entered in the previous step) and responds to ping. The host can either be an internal host or a public domain host like google.com. In order for the migration to complete, the system still needs https connectivity to FortiSIEM OS update servers: `os-pkgs-cdn.fortisiem.fortinet.com` and `os-pkgs-c8.fortisiem.fortinet.com`. Press **Next**.

Note: By default, "google.com" is shown for the connectivity test, but if configuring IPv6, you must enter an accessible internally approved IPv6 DNS server, for example: "ipv6-dns.fortinet.com"

Note: When configuring both IPv4 and IPv6, only testing connectivity for the IPv6 DNS is required because the IPV6 takes higher precedence. So update the host field with an approved IPv6 DNS server.

15. The final configuration confirmation is displayed. Verify that the parameters are correct. If they are not, then press **Back** to return to previous dialog boxes to correct any errors. If everything is OK, then press **Run**.

The options are described in the following table.

Option	Description
-r	The FortiSIEM component being configured
-z	The time zone being configured
-i	IPv4-formatted address
-m	Address of the subnet mask

Option	Description
-g	Address of the gateway server used
--host	Host name
-f	FQDN address: fully-qualified domain name
-t	The IP type. The values can be either 4 (for ipv4) or 6 (for v6) or 64 (for both ipv4 and ipv6).
--dns1, --dns2	Addresses of the DNS servers
--i6	IPv6-formatted address
--m6	IPv6 prefix
--g6	IPv6 gateway
-o	Installation option (install_without_fips , install_with_fips , enable_fips , disable_fips , change_network_config*) *Option only available after installation.
-z	Time zone. Possible values are US/Pacific , Asia/Shanghai , Europe/London , or Africa/Tunis
--testpinghost	The host used to test connectivity

- 16.** It will take some time to complete the FortiSIEM installation. If the installation is successful, then the appliance will reboot automatically. Otherwise, the appliance will stop at the failed task.

You can inspect the `ansible.log` file located at `/usr/local/fresh-install/logs` if you encounter any issues during FortiSIEM installation.

After installation completes, ensure that the `phMonitor` is up and running, for example:

```
# phstatus
```

The response should be similar to the following:

phParser	DOWN			
phQueryMaster	DOWN			
phRuleMaster	DOWN			
phRuleWorker	DOWN			
phQueryWorker	DOWN			
phDataManager	DOWN			
phDiscover	DOWN			
phReportWorker	DOWN			
phReportMaster	DOWN			
phIpIdentityWorker	DOWN			
phIpIdentityMaster	DOWN			
phAgentManager	DOWN			
phCheckpoint	DOWN			
phPerfMonitor	DOWN			
phDataPurger	DOWN			
phEventForwarder	DOWN			
phMonitor	32:18	0	1263m	568m
Apache	32:49	0	314m	17m
Rsyslogd	32:42	0	192m	4216k
Node.js-charting	32:36	0	642m	79m
Node.js-pm2	32:19	0	636m	52m
Node.js-exporter	32:31	0	10902m	59m
Node.js-jsreport	32:36	0	957m	117m
phFortiInsightAI	DOWN			
phAnomalyWorker	DOWN			
AppSvr	32:17	4	31781m	4433m
DBSvr	32:49	0	425m	37m
phAnomalyMaster	DOWN			
SVNLite	32:49	0	37923m	579m
Redis	32:21	0	204m	82m

Step 5: Generate FortiSIEM FSM-3500G License Key file from FortiCare

1. Obtain the Hardware Serial Number from FSM-3500G appliance from [FortiCare Support Services](#).
2. Follow FortiSIEM Licensing Guide [here](#) to generate the license key file - remember to use 'Hardware Serial Number' for Hardware ID.

Step 6: Register FortiSIEM License

1. Note the IP Address assigned to FortiSIEM in [Step 4](#).
2. Access FortiSIEM from browser (<https://<FortiSIEM-IP>>).
3. Upload the license file obtained from [Step 5](#) and select the **License Type** based on your deployment (note this choice can only be made once and is not reversible):
 - Enterprise for single organizations
 - Service Provider for multiple organizations
4. Click **Upload** to complete the license registration.

Step 7: Accessing FortiSIEM UI

1. Note the IP Address assigned to FortiSIEM in [Step 5](#).
2. Access FortiSIEM from browser (<https://<FortiSIEM-IP>>). Please note that if you are logging into FortiSIEM with an IPv6 address, you should input [https://\[IPv6 address\]](https://[IPv6 address]) on the browser tab.
3. Login to FortiSIEM using the default user name, password, and organization:
 - **UserID:** *admin*
 - **Password:** *admin*1*
 - **Cust/OrgID:** *super* (if shown)

Step 8: Choose an Event Database

For a fresh installation, you will be taken to the Event Database Storage page. You will be asked to choose between **Local Disk**, **NFS** or **Elasticsearch** options. For more details, see [Configuring Storage](#).

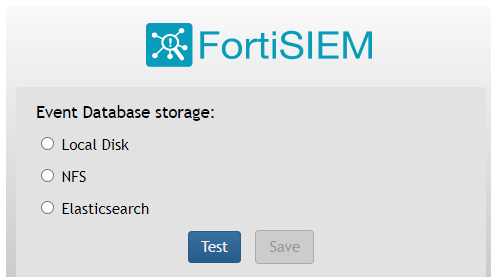

Cluster Installation

For larger installations, you can choose Worker nodes and external storage (NFS or Elasticsearch).

- [Installing the Supervisor](#)
- [Installing Workers](#)
- [Registering Workers](#)
- [Installing Collectors](#)
- [Registering Collectors](#)

Installing the Supervisor

Follow the steps in [All-in-one Installation](#) with two differences:

- Setting up hardware - you do not need an event database.
- Setting up an Event database - Configure the cluster for either NFS or Elasticsearch.

NFS

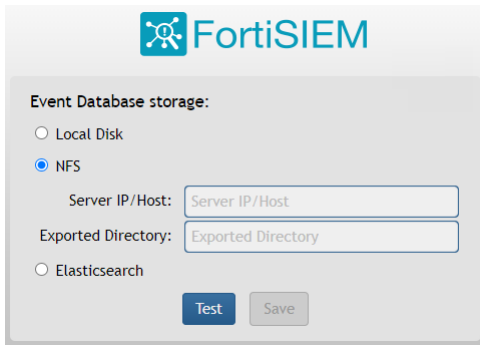

FortiSIEM

Event Database storage:

- Local Disk
- NFS
- Elasticsearch

Server IP/Host:

Exported Directory:

Elasticsearch

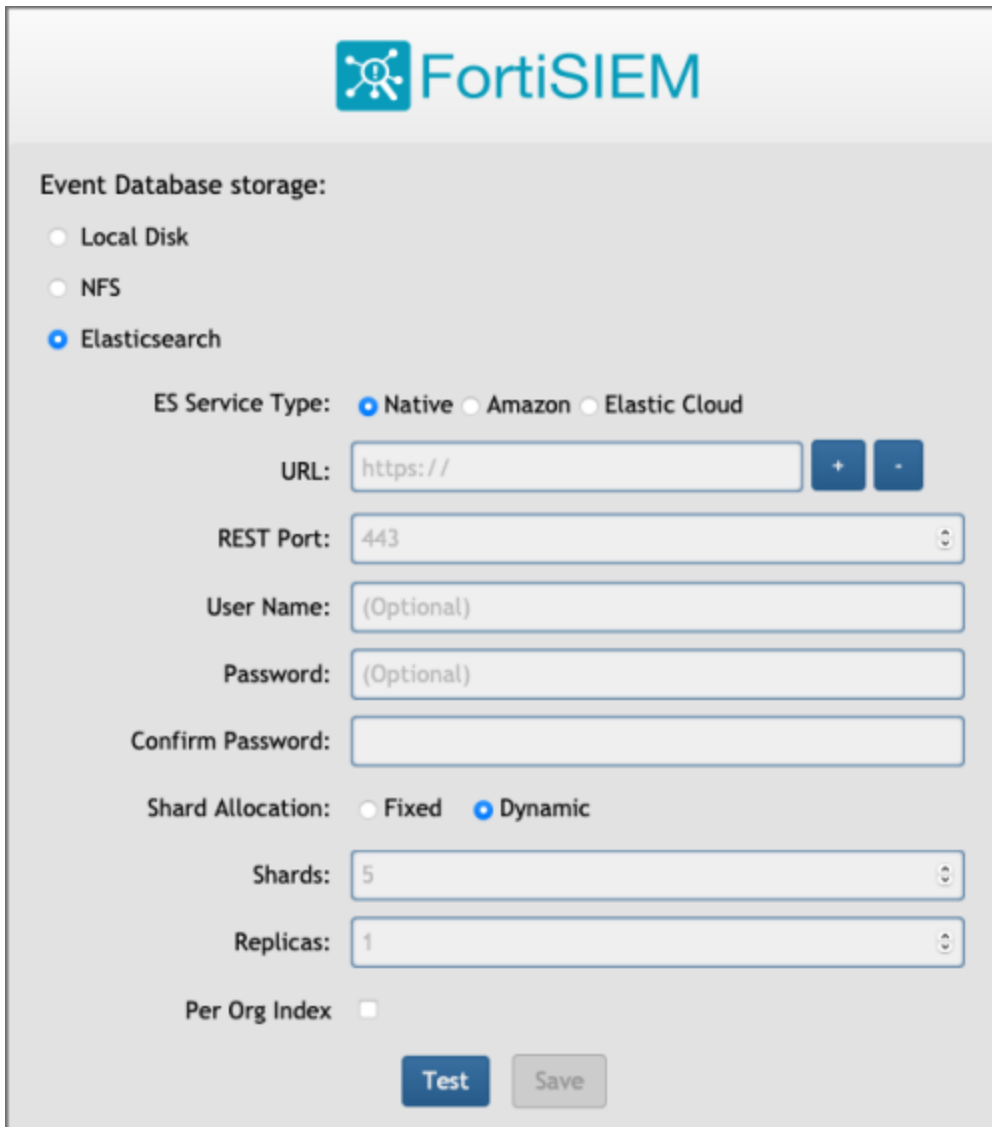

FortiSIEM

Event Database storage:

- Local Disk
- NFS
- Elasticsearch

ES Service Type: Native Amazon Elastic Cloud

URL:

REST Port:

User Name:

Password:

Confirm Password:

Shard Allocation: Fixed Dynamic

Shards:

Replicas:

Per Org Index

You must choose external storage listed in [Step 8: Choose an Event Database](#).

Installing Workers

Once the Supervisor is installed, follow the same steps in [All-in-one Installation](#) to install a Worker except that you choose **2 Worker** during [Step 4: Configure FortiSIEM via GUI substep 7](#).

Registering Workers

Once the Worker is up and running, add the Worker to the Supervisor node.

1. Go to **ADMIN > License > Nodes**.
2. Select **Worker** from the drop-down list and enter the Worker's IP address and host name. Click **Add**.

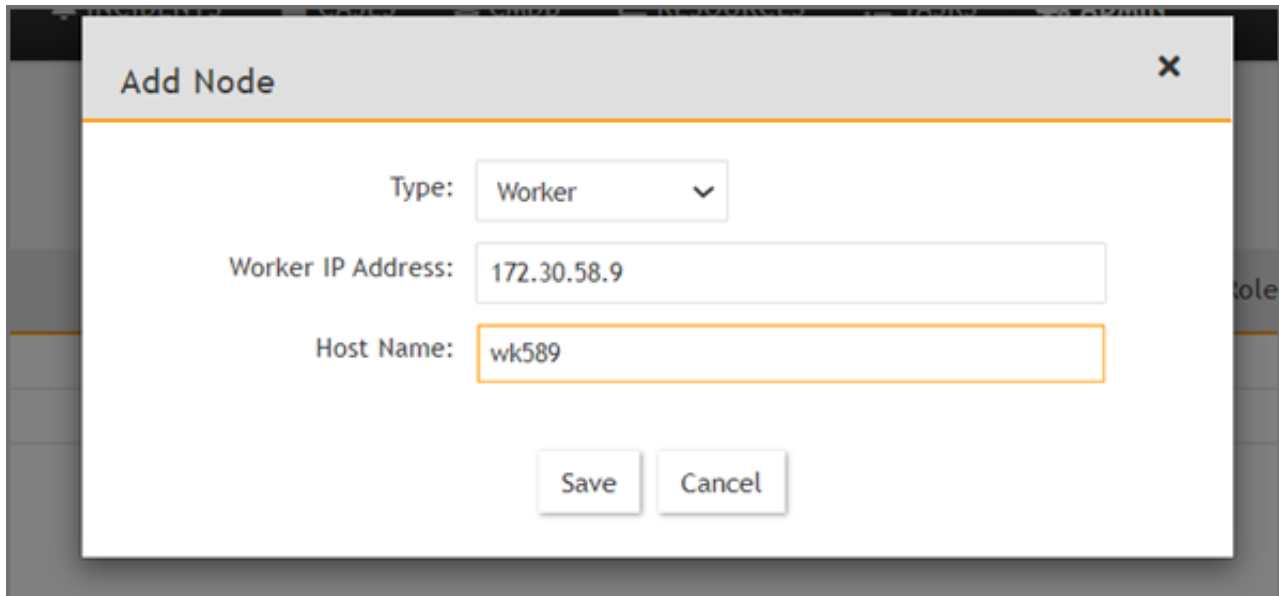

3. See **ADMIN > Health > Cloud Health** to ensure that the Workers are up, healthy, and properly added to the system.

The screenshot shows the 'Cloud Health' section of the FortiSIEM GUI. The left sidebar has 'Health' selected. The main area shows a table of nodes and a detailed view of process-level metrics for a worker node.

Name	IP Address	Module Role	Health	Version	Load Average	CPU	Swap Used
sp572.fortinet.com	172.30.57.2	Supervisor	Normal	6.1.0.1238	0.95,0.47,0.43	4%	0 KB
wk573.fortinet.com	172.30.57.3	Worker	Normal	6.1.0.1238	0.1,0.2,0.16	2%	0 KB

Process Name	Status	Up Time	CPU	Physical Memory	Virtual Memory	SharedStore ID	SharedStore Position
Node.js-charting	Up	1h 3m	0%	70 MB	916 MB		
httpd	Up	14m 6s	0%	16 MB	310 MB		
Redis	Up	14m 6s	0%	22 MB	51 MB		
Node.js-pm2	Up	1h 3m	0%	44 MB	899 MB		
rsyslogd	Up	1h 3m	0%	7 MB	189 MB		
ohDataManaaer	Up	14m 6s	0%	103 MB	1229 MB	1	126108

Installing Collectors

Once Supervisor and Workers are installed, follow the same steps in [All-in-one Install](#) to install a Collector except only choose OS and OPT disks. The recommended settings for Collector node are:

- CPU = 4
- Memory = 8GB
- Two hard disks:
 - OS – 25GB
 - OPT – 100GB

For OPT - 100GB, the 100GB disk for /opt will consist of a single disk that will split into 2 partitions, /OPT and swap. The partitions will be created and managed by FortiSIEM when `configFSM.sh` runs.

Registering Collectors

Collectors can be deployed in Enterprise or Service Provider environments.

- [Enterprise Deployments](#)
- [Service Provider Deployments](#)

Enterprise Deployments

For Enterprise deployments, follow these steps.

1. Log in to Supervisor with 'Admin' privileges.
2. Go to **ADMIN > Settings > System > Event Worker**.
 - a. Enter the IP of the Worker node. If a Supervisor node is only used, then enter the IP of the Supervisor node. Multiple IP addresses can be entered on separate lines. In this case, the Collectors will load balance the upload of events to the listed Event Workers.

Note: Rather than using IP addresses, a DNS name is recommended. The reasoning is, should the IP addressing change, it becomes a matter of updating the DNS rather than modifying the Event Worker IP addresses in FortiSIEM.
 - b. Click **OK**.
3. Go to **ADMIN > Setup > Collectors** and add a Collector by entering:
 - a. **Name** – Collector Name
 - b. **Guaranteed EPS** – this is the EPS that Collector will always be able to send. It could send more if there is excess EPS available.
 - c. **Start Time** and **End Time** – set to **Unlimited**.
4. SSH to the Collector and run following script to register Collectors:

```
# /opt/phoenix/bin/phProvisionCollector --add <user> '<password>' <Super IP or Host> <Organization> <CollectorName>
```

The password should be enclosed in single quotes to ensure that any non-alphanumeric characters are escaped.

 - a. Set `user` and `password` using the admin user name and password for the Supervisor.
 - b. Set `Super IP or Host` as the Supervisor's IP address.
 - c. Set `Organization`. For Enterprise deployments, the default name is Super.
 - d. Set `CollectorName` from [Step 2a](#).
The Collector will reboot during the Registration.

5. Go to **ADMIN > Health > Collector Health** for the status.

The screenshot shows the 'Collector Health' page in FortiSIEM. The top navigation bar includes 'Setup', 'Device Support', 'Health', 'License', and 'Settings'. The 'Health' section is active, showing 'Cloud Health' and 'Collector Health' tabs. Below the tabs, there are search and action buttons. The main content area displays a table of collector status:

Organization	Name	IP Address	Status	Health	Up Time	CPU	Memory	Allocated EPS	Incoming EPS	Version	Col
Super	CO-ORG	172.30.57.4	up	Normal	3m 4s	65%	5%	200	0	6.1.0...	100

Below this table, there is a 'Close Panel' button and a search bar. A second table shows process details:

Process Name	Status	Up Time	CPU	Physical Memory	Virtual Memory	SharedStore ID	SharedStore Position
phMonitorAgent	Up	29s	0%	575 MB	1116 MB		
phParser	Up	17s	0%	106 MB	1190 MB	99	0
phPerfMonitor	Up	17s	0%	79 MB	766 MB		
phEventForwarder	Up	17s	0%	48 MB	547 MB		
phDiscover	Up	17s	0%	53 MB	513 MB		

Service Provider Deployments

For Service Provider deployments, follow these steps.

1. Log in to Supervisor with 'Admin' privileges.
2. Go to **ADMIN > Settings > System > Event Worker**.
 - a. Enter the IP of the Worker node. If a Supervisor node is only used, then enter the IP of the Supervisor node. Multiple IP addresses can be entered on separate lines. In this case, the Collectors will load balance the upload of events to the listed Event Workers.

Note: Rather than using IP addresses, a DNS name is recommended. The reasoning is, should the IP addressing change, it becomes a matter of updating the DNS rather than modifying the Event Worker IP addresses in FortiSIEM.
 - b. Click **OK**.

The screenshot shows the 'Event Worker' configuration page in FortiSIEM. The navigation path is 'All Settings > System > Event Worker'. The page contains a 'Worker Address' field with the value '172.30.57.3' and '+' and '-' buttons for adding or removing addresses. A 'Save' button is located below the field.

c. **Settings**

3. Go to **ADMIN > Setup > Organizations** and click **New** to add an Organization.

4. Enter the **Organization Name**, **Admin User**, **Admin Password**, and **Admin Email**.

5. Under **Collectors**, click **New**.

6. Enter the **Collector Name**, **Guaranteed EPS**, **Start Time**, and **End Time**.

The last two values could be set as **Unlimited**. **Guaranteed EPS** is the EPS that the Collector will always be able to send. It could send more if there is excess EPS available.

7. SSH to the Collector and run following script to register Collectors:

```
# /opt/phoenix/bin/phProvisionCollector --add <user> '<password>' <Super IP or Host> <Organization> <CollectorName>
```

The password should be enclosed in single quotes to ensure that any non-alphanumeric characters are escaped.

- a. Set `user` and `password` using the admin user name and password for the Organization that the Collector is going to be registered to.
- b. Set `Super IP or Host` as the Supervisor's IP address.
- c. Set `Organization` as the name of an organization created on the Supervisor.

d. Set CollectorName from Step 6.

```

root@co574 ~# phProvisionCollector
Usage: phProvisionCollector --add <Organization-user-name> <Organization-user-password> <Supervisor-IP> <Organization-name> <Collector-name>
root@co574 ~# phProvisionCollector --add admin Admin=11 172.30.57.2 ORG CO-ORG
Continuing to provision the Collector
This collector is registered successfully. Normal Exit and restart of phMonitor after collector license registration.
root@co574 ~# _
    
```

The Collector will reboot during the Registration.

8. Go to **ADMIN > Health > Collector Health** and check the status.

The screenshot shows the 'Collector Health' page in the FortiSIEM interface. It features a left-hand navigation menu with 'Health' selected. The main content area displays a table of collector status and a detailed view of running processes.

Organization	Name	IP Address	Status	Health	Up Time	CPU	Memory	Allocated EPS	Incoming EPS	Version	Col
Super	CO-ORG	172.30.57.4	up	Normal	3m 4s	65%	5%	200	0	6.1.0...	100

Process Name	Status	Up Time	CPU	Physical Memory	Virtual Memory	SharedStore ID	SharedStore Position
phMonitorAgent	Up	29s	0%	575 MB	1116 MB		
phParser	Up	17s	0%	106 MB	1190 MB	99	0
phPerfMonitor	Up	17s	0%	79 MB	766 MB		
phEventForwarder	Up	17s	0%	48 MB	547 MB		
phDiscover	Up	17s	0%	53 MB	513 MB		

Factory Reset

Follow the steps below to perform factory reset on FortiSIEM FSM-3500G.

- [Step 1: Uninstall FortiSIEM application](#)
- [Step 2: Reinstall FortiSIEM application](#)

Step 1: Uninstall FortiSIEM application

1. Connect FortiSIEM device using VGA or Console port.
2. Login as `root` user with the new password you set in [Step 3: Verify System Information](#).
3. To check the available FortiSIEM commands, run `sudo get`.
4. To uninstall FortiSIEM, run `sudo execute fsm-clean`.
This script will uninstall FortiSIEM application.
5. Reboot the system.

Step 2: Reinstall FortiSIEM application

1. Login as `root` with password `ProspectHills`. You will immediately be asked to change your password.
2. To configure RAID, run `execute format disk`.
3. To check Hardware status and RAID information, run `diagnose hardware info`.
4. To install FortiSIEM, run the `execute factoryreset --force` command. The command fails after partial steps. Run the same command again to complete `factoryreset`.
This script takes a few minutes to complete FortiSIEM installation.
5. Reboot and run `/user/local/bin/configFSM.sh` to install FortiSIEM.

Follow the steps under [Appliance Setup](#) to configure FSM-3500G.



www.fortinet.com

Copyright© 2024 Fortinet, Inc. All rights reserved. Fortinet®, FortiGate®, FortiCare® and FortiGuard®, and certain other marks are registered trademarks of Fortinet, Inc., and other Fortinet names herein may also be registered and/or common law trademarks of Fortinet. All other product or company names may be trademarks of their respective owners. Performance and other metrics contained herein were attained in internal lab tests under ideal conditions, and actual performance and other results may vary. Network variables, different network environments and other conditions may affect performance results. Nothing herein represents any binding commitment by Fortinet, and Fortinet disclaims all warranties, whether express or implied, except to the extent Fortinet enters a binding written contract, signed by Fortinet's General Counsel, with a purchaser that expressly warrants that the identified product will perform according to certain expressly-identified performance metrics and, in such event, only the specific performance metrics expressly identified in such binding written contract shall be binding on Fortinet. For absolute clarity, any such warranty will be limited to performance in the same ideal conditions as in Fortinet's internal lab tests. Fortinet disclaims in full any covenants, representations, and guarantees pursuant hereto, whether express or implied. Fortinet reserves the right to change, modify, transfer, or otherwise revise this publication without notice, and the most current version of the publication shall be applicable.