



January 31, 2023
Revision 1

Copyright © 2023 Fortinet, Inc. All rights reserved. Fortinet®, FortiGate®, FortiCare® and FortiGuard®, and certain other marks are registered trademarks of Fortinet, Inc., in the U.S. and other jurisdictions, and other Fortinet names herein may also be registered and/or common law trademarks of Fortinet. All other product or company names may be trademarks of their respective owners. Performance and other metrics contained herein were attained in internal lab tests under ideal conditions, and actual performance and other results may vary. Network variables, different network environments and other conditions may affect performance results. Nothing herein represents any binding commitment by Fortinet, and Fortinet disclaims all warranties, whether express or implied, except to the extent Fortinet enters a binding written contract, signed by Fortinet's General Counsel, with a purchaser that expressly warrants that the identified product will perform according to certain expressly-identified performance metrics and, in such event, only the specific performance metrics expressly identified in such binding written contract shall be binding on Fortinet. For absolute clarity, any such warranty will be limited to performance in the same ideal conditions as in Fortinet's internal lab tests. In no event does Fortinet make any commitment related to future deliverables, features or development, and circumstances may change such that any forward-looking statements herein are not accurate. Fortinet disclaims in full any covenants, representations, and guarantees pursuant hereto, whether express or implied. Fortinet reserves the right to change, modify, transfer, or otherwise revise this publication without notice, and the most current version of the publication shall be applicable.

Contents

Contents	3
Register for Support	4
Box Includes	5
Attaching the stand	6
Installation	6
Connecting the phone	7
Setting up the phone	8
Using the Phone	9
Troubleshooting	11
Cautions and Warnings	12
Regulatory Compliance	13

Register for Support

Register your Fortinet product to receive:

- Technical Support
- New product features
- Protection from new threats

Vous devez enregistrer le produit pour recevoir:

- Support technique
- Nouvelles fonctionnalités du produit
- Protection contre de nouvelles menaces

La reistrazione ti permette di usufruire di:

- Supporto Tecnico
- Nuove funzionalita
- Protezione dalle ultime minacce

Debe registrar el producto para recibir:

- Apoyo técnico
- Nuevas funcionalidades del producto
- Protección contra ataques

登録のお願い

本日、フォーティネット製品の登録をしてください。

登録すると次のメリットがあります。

テクニカルサポート • 新機能の追加 • 新しい脅威への防御

请马上注册

您的飞塔产品

您在注册以后才能得到技术支持、新产品特点信息、最新威胁防护

<https://support.fortinet.com>

Toll free: 1 866 648 4638

Phone: 1 408 486 7899

Fax: 1 408 235 7737

Email: register@fortinet.com

Box Includes

This guide describes how to set up your phone and provides a brief overview of its features. Start by configuring an extension in the phone system. Refer to the [FortiVoice Administration Guide](#) for information about configuring an extension.

For further details about your phone, please see the [FON-x80 Series User Guide](#).

The following items are included in the box:

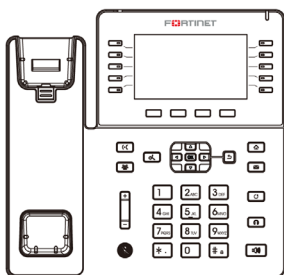

FON-480B

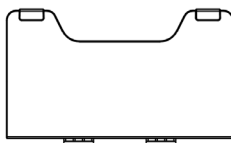

Stand

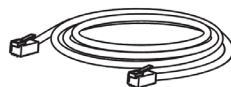

Ethernet Cable



Handset

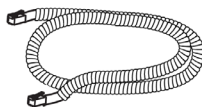

Handset Cord

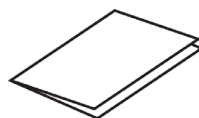

Quick Start Guide

1 Installation



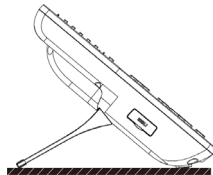
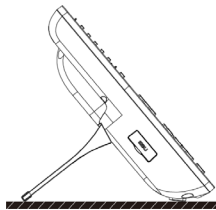
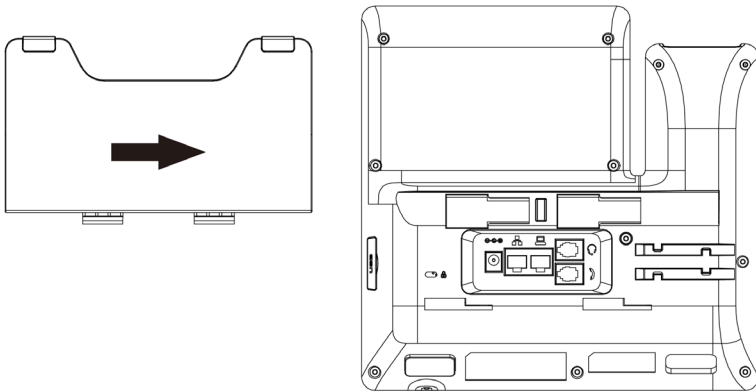

Attaching the stand

1. Line the posts on the top of the base with the holes on the back of the phone, depending on the level of tilt you prefer.
2. Slide sideways into place until secure.

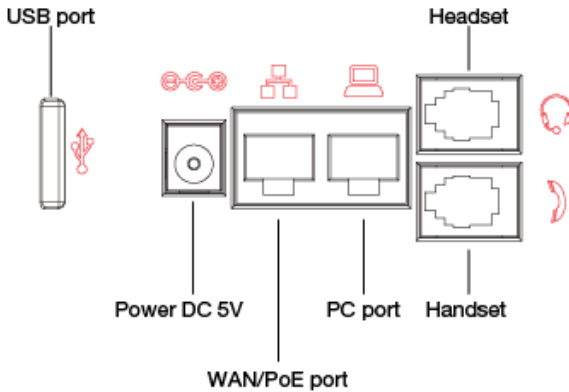

Connecting the phone



1. Connect the handset cord to the handset  jack on the phone.
2. Optionally, connect an amplified headset to the  jack.
3. Connect the WAN port  to the network with the provided Ethernet cable.
4. Optionally, connect your desktop PC to the PC port  with an Ethernet cable (not supplied).
5. If the network supports PoE, a power adapter is not required. The phone requires a DC 48V 0.3A PoE connection. If PoE is not supported on the network, connect a DC 5V 2A power adapter to the power jack.

Setting up the phone

For use as an internal extension

The phone supports plug and play installation and will automatically download its configuration from the FortiVoice system. The phone will display the extension number and name when it has registered.

For use as an external extension

The phone can be used outside of the FortiVoice location as an external extension. The phone must manually be configured to contact the Provisioning Server (the FortiVoice unit) in order to obtain registration information:

1. On the phone, press the **Menu** button.
2. Select **Settings > Provisioning**.
3. Enter the password as **23646**.
4. Select **Static Provisioning Server**.
5. Set the **Server** as the public IP address of the FortiVoice unit.
6. Press **OK**.

For use as a cloud extension







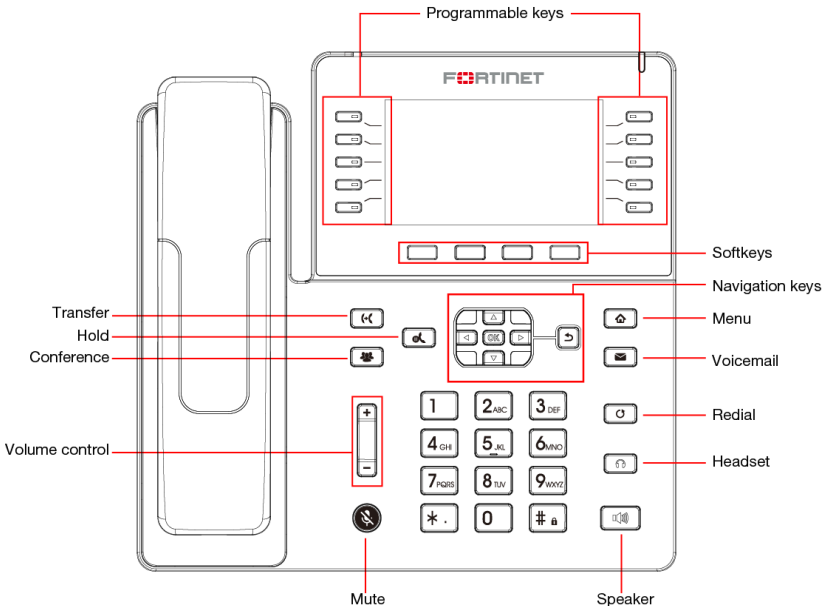





The phone can be used with the FortiVoice Cloud service as an extension. The phone must be manually configured in order to register with the service.

1. On the phone, press the **Menu** button.
2. Select **Cloud**.
3. Enter the **Cloud ID** and press **OK**.
4. Enter the **User ID** and press **OK**.
5. Enter the **PIN** and select **Submit**.

2 Using the Phone



Softkey	Function
History	Accesses the call history.
Contact	Accesses the contact lists.
DND	Toggles Do Not Disturb on and off.
Menu	Accesses the phone menu.

Button	Function
	Navigation keys — used to navigate items within the History/Contact/Menu .
	Hold — places and retrieves calls on hold.
	Transfer — transfers calls to another extension or outside line.
	Conference — creates a conference call with another extension or outside line.
	Volume control — adjusts the volume of the handset/headset/speaker.
	Mute — toggles the microphone on and off.
	Home/Menu — accesses the menu of the phone where settings, features and phone information is available. When in Menu, press to return to idle screen.
	Voicemail — accesses voicemail and voicemail greetings.
	Redial — places a call to the last number dialed.
	Headset — toggles the headset on and off.
	Speakerphone — toggles the speaker on and off.
	Programmable keys — can be configured for a variety of functions such as appearances for extensions/park/lines. Consult the FortiVoice Administration Guide for more information on programmable keys.

3 Troubleshooting

Symptom	Corrective Action
Display is blank	<p>Confirm the phone's power source.</p> <ol style="list-style-type: none"> If you are using Power over Ethernet (PoE): <ul style="list-style-type: none"> Ensure your Ethernet cable is plugged into the WAN port on the back of your phone. Ensure the PoE switch is properly configured. If it still doesn't work, replace the Ethernet cable. If you are using the power adapter: <ul style="list-style-type: none"> Ensure it is plugged in. If it still doesn't work, replace the power adapter.
Phone not receiving a DHCP IP Address	<p>The DHCP server is not responding.</p> <ol style="list-style-type: none"> Ensure your DHCP server is online. This is typically your router. Reboot the router or DHCP server. If you are still experiencing issues, the phone may require advanced network configuration. Please contact your administrator or refer to the FON-x80 Series User Guide.
No name and extension number is displayed	<p>Your phone is not registered.</p> <ol style="list-style-type: none"> On the <i>Extensions</i> page of the FortiVoice interface, ensure the MAC address is correctly entered and the <i>Phone Type</i> is <i>FON-480</i>. Save your configuration and reboot the phone. If your phone is configured as an external extension, ensure the <i>Server Address</i> is correct. To verify, see "For use as an external extension". If your phone is configured as an external extension, check the network connection and firewall settings at the FortiVoice location.
No audio during a call	<ol style="list-style-type: none"> Check the handset/headset connections. Make sure the phone is properly registered with the FortiVoice unit. If your phone is configured as an external extension, check the network connection and firewall settings at the FortiVoice location.

Cautions and Warnings

Environmental specifications

Refer to specific Product Model Data Sheet for Environmental Specifications (Operating Temperature, Storage Temperature, Humidity, and Altitude).

Référez à la Fiche Technique de ce produit pour les caractéristiques environnementales (Température de fonctionnement, température de stockage, humidité et l'altitude).

Safety

Caution: This equipment is to be used in a Network Environment 0 per IECTR 62101. This product is connected only to PoE networks without routing to the outside plant.

Attention : Ce matériel doit être utilisé dans un Environnement Réseau 0 par IECTR 62101. Ce produit est uniquement connecté aux réseaux PoE sans installation externe de routage.

This product is intended to be supplied by a Listed Direct Plug-In Power Unit marked LPS or Class 3 and rated 5 Vdc, 2 A or by 48 Vdc from PoE source.

Le produit doit être alimenté par un bloc d'alimentation à courant continu homologué UL de 5 Vdc, 2 A nominal marqué LPS ou Class 3 ou par une source d'alimentation par Ethernet de 48 Vdc (PoE).

This product should be mounted at a height of less than 2 meters.

Ce produit doit être monté à une hauteur de moins de 2 mètres.

E911 and use with multi-line telephone systems

Please note the use and operation of this phone as part of a multi-line telephone system (MLTS) may be subject to state and/or federal E911 MLTS laws that require the MLTS to provide a caller's telephone number, extension, and physical location to applicable state and/or local emergency services when a caller initiates a 911 call. The MLTS may not provide a caller's telephone number, extension, or physical location information to emergency services when a caller dials 911, and compliance with state and/or federal E911 MLTS laws is the sole responsibility of the purchaser of this phone.

Privacy

This phone implements security and encryption technologies. However, privacy of communications may not be ensured when using this telephone.

Regulatory Compliance

Federal Communication Commission (FCC) – USA

This device complies with Part 15 of FCC Rules. Operation is subject to the following two conditions:

- (1) this device may not cause harmful interference, and
- (2) this device must accept any interference received; including interference that may cause undesired operation.

This equipment has been tested and found to comply with the limits for a Class B digital device, pursuant to Part 15 of the FCC Rules. These limits are designed to provide reasonable protection against harmful interference in residential installation. This equipment generates, uses, and can radiate radio frequency energy, and if it is not installed and used in accordance with the instruction manual, it may cause harmful interference to radio communications. However, there is no guarantee that interference will not occur in a particular installation.

If this equipment does cause harmful interference to radio or television reception, which can be determined by turning the equipment off and on, the user is encouraged to try to correct the interference by one or more of the following measures:

- Reorient or relocate the receiving antenna.
- Increase the separation between the equipment and receiver.
- Connect the equipment into an outlet on a circuit different from that to which the receiver is connected.
- Consult the dealer or an experienced radio/TV technician for help.

Warning: Any changes or modifications to this unit not expressly approved by the party responsible for compliance could void the user's authority to operate the equipment.

This equipment complies with FCC radiation exposure limits set forth for an uncontrolled environment. This equipment should be installed and operated with minimum distance of 20cm between the radiator and your body. This transmitter must not be co-located or operating in conjunction with any other antenna or transmitter.

Industry Canada Equipment Standard for Digital Equipment (ICES) – Canada

This Class B digital apparatus complies with Canadian ICES-003.

Cet appareil numérique de la classe B est conforme à la norme NMB-003 du Canada.

Innovation, Science and Economic Development (ISED) – Canada

This device contains licence-exempt transmitter(s)/receiver(s) that comply with Innovation, Science and Economic Development Canada's licence-exempt RSS(s). Operation is subject to the following two conditions:

- (1) This device may not cause interference.
- (2) This device must accept any interference, including interference that may cause undesired operation of the device.

L'émetteur/récepteur exempt de licence contenu dans le présent appareil est conforme aux CNR d'Innovation, Sciences et Développement économique Canada applicables aux appareils radio exempts de licence. L'exploitation est autorisée aux deux conditions suivantes:

- (1) L'appareil ne doit pas produire de brouillage;

(2) L'appareil doit accepter tout brouillage radioélectrique subi, même si le brouillage est susceptible d'en compromettre le fonctionnement.
This equipment complies with ISED radiation exposure limits set forth for an uncontrolled environment. This equipment should be installed and operated with minimum distance of 20cm between the radiator and your body.

Cet équipement est conforme aux limites d'exposition aux rayonnements ISED établies pour un environnement non contrôlé. Cet équipement doit être installé et utilisé avec un minimum de 20cm de distance entre la source de rayonnement et votre corps.

This device and its antennas(s) must not be co-located or operating in conjunction with any other antenna or transmitter except in accordance with IC multi-transmitter product procedures.

Cet appareil et son antenne (s) ne doit pas être co-localisés ou fonctionnement en association avec une autre antenne ou transmetteur.

European Conformity (CE) – EU

This is a Class B product. In a domestic environment, this product may cause radio interference, in which case the user may be required to take adequate measures.



The product transmits within the frequency ranges and less than or equal to the power listed below:

2402-2480 MHz less than 20dBm

Simplified EU Declaration of Conformity

This declaration is only valid for Fortinet products (including combinations of software, firmware and hardware) provided by Fortinet or Fortinet's authorized partners to the end-customer directly for use within the EU or countries that have implemented the EU Directives and/or spectrum regulation. Any Fortinet products not obtained directly from Fortinet or Fortinet's authorized partners may not comply with EU Directives and Fortinet makes no assurances for such products.

Български
Този продукт е в съответствие с Директива 2014/53/ЕС.

Česky
Tento produkt je v souladu se směrnici 2014/53/EU.

Dansk
Dette produkt er i overensstemmelse med direktiv 2014/53/EU.

Deutsch
Dieses Produkt entspricht der Richtlinie 2014/53/EU.

Eesti
See toode vastab direktiivile 2014/53/EL.

English
This product is in compliance with Directive 2014/53/EU.

Español
Este producto cumple con la Directiva 2014/53/UE.

Ελληνική
Το προϊόν αυτό συμμορφώνεται με την Οδηγία 2014/53/ΕΕ.

Français
Ce produit est conforme à la Directive 2014/53/UE.

Hrvatski
Ovaj proizvod je u skladu s Direktivom 2014/53/EU.

Italiano
Questo prodotto è conforme alla Direttiva 2014/53/EU.

Latviski
Šis produkts atbilst 2014/53/EU Direktīvai.

Lietuvių

Sis gaminys atitinka direktyvą 2014/53/ES.

Malti

Dan il-prodott huwa konformi mad-Direttiva 2014/53/UE.

Magyar

Ez a termék megfelel a 2014/53/EU irányelvnek.

Nederlands

Dit product is in overeenstemming met Richtlijn 2014/53/EU.

Norsk

Denne produktet er i samsvar med direktiv 2014/53/EU.

Polski

Ten produkt jest zgodny z dyrektywą 2014/53/UE.

Português

Este produto está em conformidade com a Diretiva 2014/53/UE.

Rumunski

Acest produs este în conformitate cu Directiva 2014/53/UE.

Slovensky

Tento produkt je v súlade so smernicou 2014/53/EÚ.

Slovensko

Ta izdelek je v skladu z Direktivo 2014/53/EU.

Suomi

Tämä tuote on direktiivin 2014/53/EU mukainen.

Svenska

Denna produkt överensstämmer med direktiv 2014/53/EU.

Note: The full declaration of conformity for this product is available at the link below:

<https://site.fortinet.com/ProductRegulatory/EU>

Fortinet Customer Service & Support

Create a support account, register and manage your products, download updates, firmware images and release notes, and create technical support tickets.

<https://support.fortinet.com>

Fortinet Document Library

Up-to-date versions of Fortinet publications for the entire family of Fortinet products.

<https://docs.fortinet.com>

Training Services

Course descriptions, availability, schedules, and location of training programs in your area.

<https://www.fortinet.com/support-and-training/training.html>

Technical Discussion Forums

Communicate with other customers and Fortinet partners about Fortinet products, services, and configuration issues.

<https://support.fortinet.com/forum>

FortiGuard Threat Research and Response

Up-to-date information on vulnerabilities and threats, includes a virus scanner, IP signature look-up, and web filtering tools.

<https://fortiguard.com>